



# User Manual

## Wind Speed Indicator & Wind Displays

(Parts 1086-PK-XXX)

Doc No: 1086-PS-0050

Issue 8



Gill Instruments Limited  
Saltmarsh Park, 67 Gosport Street, Lymington,  
Hampshire, SO41 9EG, UK  
Tel: +44 1590 613500, Fax: +44 1590 613555  
Email: [anem@gillinstruments.com](mailto:anem@gillinstruments.com) Website: [www.gillinstruments.com](http://www.gillinstruments.com)

FOREWORD.....	3
Introduction .....	3
Display Part Numbers.....	3
1 PACKING LIST.....	4
2 SUMMARY OF ABBREVIATIONS USED.....	4
3. GENERAL .....	5
3.1 The WindDisplay is available in two designs. ....	5
Principal characteristics .....	5
4 INSTALLATION.....	6
4.1 Display Bench Test .....	6
Mechanical.....	6
4.3 Electrical.....	7
4.3.1 Power supply.....	7
4.3.2 Cable and Layout .....	7
4.3.3 Anemometer Connections.....	8
4.3.3.1 WindSonic.....	8
4.3.3.2 WindObserver.....	8
4.3.4 Daisy Chain Connections .....	8
4.3.5 RS232 PC Connection .....	9
5 Commissioning.....	9
5.1 Anemometer Settings.....	9
5.2 Display Tests.....	9
5.3 System Test.....	10
5.4 Settings via the front panel.....	11
5.4.1 Brightness Control.....	11
5.4.2 Min – Max Wind (Gust) Speed Indication.....	11
5.4.3 Average Interval Settings .....	11
5.4.4 Units of Measurement .....	12
5.4.5 LED Test.....	12
5.4.6 Gust Reading Reset (when in user average mode).....	12
5.4.7 Wind Direction Offset Setting .....	12
5.5 Settings via PC .....	12
5.6 Dimming Display Remotely (Option) .....	18
5.7 Analogue Outputs (Option).....	18
5.8 Fault Finding.....	18
6 Maintenance .....	19
7 Appendix/Drawings .....	19
7.1 ELECTRICAL CONFORMITY STATEMENT .....	19
APPENDIX 1 – General Assembly .....	20
APPENDIX 2 – Cable information .....	20
APPENDIX 3 – Electrical connections.....	21
APPENDIX 4 – Daisy chain connections.....	22
APPENDIX 5 – Rear view of WindDisplay.....	23
APPENDIX 6 – WindDisplay Dimmer Switch Connection .....	24
APPENDIX 7 - Dimmer Switch Dimensions .....	24

## FOREWORD

This manual refers to the WindDisplay supplied by Gill Instruments.

The WindDisplay is a sophisticated instrument and to achieve optimum performance, we recommend that you read the whole of this manual before proceeding to use the equipment.

Gill products are in continuous development and therefore specifications may be subject to change without prior notice.

The information contained in this manual remains the property of Gill Instruments and as such, it should not be copied or re-produced for commercial gain.

## Introduction

The Gill digital WindDisplay is a combined wind speed and direction indicator. The WindDisplay comprises two, 3 digit LED arrays to provide instantaneous wind speed and maximum or minimum gust data. A double ring of 36 LEDs is used to indicate instantaneous and average direction information.

A second 3 digit display at the lower right hand corner provides gust information.

The front panel provides three buttons "MENU", "▲" and "▼" which may be used to adjust the brightness of the LEDs, enter a display mode or enter a set up mode.

The WindDisplay will accept RS422 data output (see Para 4.3.3 for display input format) directly from **Gill WindObserver** and **Gill WindSonic** anemometers without the need for additional interfaces. It provides the power supply to the anemometer and "daisy-chain" connections are available for additional WindDisplays. See **Appendix 4**.

The display is housed in a 144mm x 144mm DIN-size casing suitable for flush mounting and must be mounted in a console or display panel. Unit depth is 77 mm.

The WindDisplay may be user-configured to display the wind speed in various scales, i.e. miles per hour (mph), metres per second (m/s), knots (kn), kilometres per hour (km/h) and Beaufort (Bft).

### Display Part Numbers.

Part Numbers for Meteorological Displays, 0° - 359° scale

Gill Part	Supply Voltage	Data Format	Baud Rate	Analogue Output
1086-PK-073	220v AC	Gill ASCII	9600	No
1086-PK-086	110v AC	Gill ASCII	9600	No
1086-PK-093	220V AC	Gill ASCII	9600	4-20mA, 0-60m/s

Part Numbers for Marine Displays 0° - 180° - 0° scale

Gill Part	Supply Voltage	Data Format	Baud Rate	Analogue Output
1086-PK-083	220v AC	NMEA	4800	No
1086-PK-085	110v AC	NMEA	4800	No
1086-PK-072	220v AC	Gill ASCII	9600	No
1086-PK-084	110v AC	Gill ASCII	9600	No

## 1 PACKING LIST

- WindDisplay
- Mounting lugs

## 2 SUMMARY OF ABBREVIATIONS USED

<b>ac</b> .....	Alternating current
<b>Bft</b>	Beaufort scale
<b>dc</b> .....	Direct current
<b>km/h</b>	Kilometres per hour
<b>kn</b>	Knots
<b>LED</b> .....	Light Emitting Diode
<b>mA</b>	Milliamp
<b>mph</b>	Miles per hour
<b>m/s</b>	Metres per second
<b>PCB</b> .....	Printed Circuit Board

### 3. GENERAL

#### 3.1 The WindDisplay is available in two designs.

Meteorological Display



Marine Display



#### Principal characteristics

Characteristic	Detail
Power supply	220Vac, 110v ac or 24v dc options
Speed display	3 digit 7 segment LED display 14.3mm height
Gust display	3 digit 7 segment LED display 10.1mm height
Direction display	36 LEDs circular colour RED
Direction average	36 LEDs circular colour AMBER
Data Input Format	RS422, Gill ASCII or NMEA 0183 options
Data input Baud Rate	9600 or 4800 baud option
Data input update rate	1Hz
Data Input units	Metres per second only
Data Output	Daisy chain RS422, ASCII, NMEA
Current Outputs	4-20mA, 0-90m/s option for direction and speed.
Supply Output	15v dc to anemometer
Dimensions	144 x 144 x 77 mm
Weight	Approximately 0.8kg
Brightness control	From the front panel control or external switch option (OMC129).
Readout units	m/s, km/h, knots, mph and bft

Averaging	Front panel setting, none, 2 mins and 10 mins
Environmental	-30 degrees C to +60 degrees C
Moisture	IP40
Humidity	0% to 90%
EMC	BS EN 50081-1:1992 (Emissions Class B)

## 4 INSTALLATION

### INSTALLATION AND COMMISSIONING MUST BE COMPLETED BY QUALIFIED PERSONNEL

#### 4.1 Display Bench Test

Prior to physically mounting the WindDisplay in its final location, we strongly recommend that a bench system test be carried out to confirm the system is configured correctly, is fully functional and electrically compatible with the selected host system and cabling (preferably utilising the final cable length). The required data format, Baud rate and other options should also all be configured at this stage.

#### Mechanical

Panel mounting of the WindDisplay requires a panel cut-out of 138mm square.

Maximum panel thickness is 5mm.

Rear access must be provided for fixing of the tightening clamps and connecting the electric cabling.

The depth of the units is 77mm and an additional clearance of 8mm should be allowed for the cable connections and strain relief.

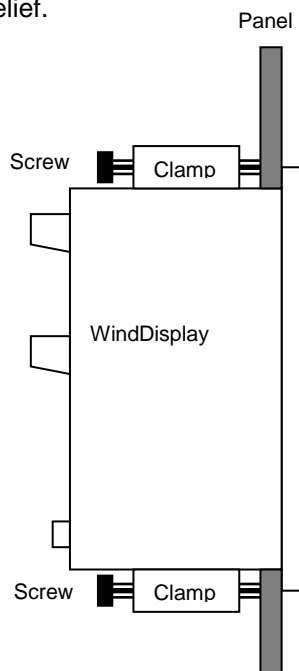

### 4.3 Electrical

The WindDisplay utilises a common terminal strip for connections to the anemometers and ancillary displays.

The WindDisplay provides the 15 Volts dc power supply to the anemometer.

The WindDisplay cannot supply power to anemometer heaters.

NOTES.

For mains operated displays ensure that a mains Earth connection is made via the E terminal on the display.

#### 4.3.1 Power supply

**HAZARD WARNING! EXPOSED LIVE VOLTAGES ON REAR TERMINALS. ENSURE WindDisplay IS DISCONNECTED FROM MAINS BEFORE ACCESSING REAR PANEL!**

Note: Information regarding internal fuse ratings and replacement can be found in section 6 of this manual.

The WindDisplay power supply can be supplied set for 220 V AC, 110v AC or 24v DC operation when ordered.

If subsequently after delivery the customer requires a different supply voltage, the following will apply:

- **The unit can be returned to Gill Instruments for adjustment.**

Power Supply connections to the rear of the display are:-

**See also Appendix 3**

Supply Voltage	Wind Display Power Terminals		
	L	N	E
<b>230v AC</b>	<b>Live</b>	<b>Neutral</b>	<b>Earth</b>
<b>115v AC</b>	<b>Live</b>	<b>Neutral</b>	<b>Earth</b>
<b>24v DC</b>	<b>+24v dc</b>	<b>0v</b>	<b>Earth</b>

#### 4.3.2 Cable and Layout

##### Mains Cable

The mains cable should be a 3 core type with a rating of 3 Amps or above.

Wire size for 3A is 0.5mm<sup>2</sup> (e.g. 16 x 0.2mm).

##### Data Cable

The data cable between the wind sensor and display should be an RS422 compatible 2 pair (4-wire) cable with 2 twisted wires for power to the sensor and 2 twisted wires for signal transmission and a screen wire/s.

Wire size of 7/0.2mm (24AWG would be suitable).

Cable length with an approved RS422 cable can be up to 1km.

An example suitable 2 pair cable is Belden Part 9729.

### 4.3.3 Anemometer Connections

#### 4.3.3.1 WindSonic

WindSonic Connector			WindDisplay	
Signal Name	Pin No.		Pin No.	Signal Name
TXD +	4	→	8	RS422 in +
TXD-	5	→	7	RS422 in -
Supply +ve	2	→	2	Supply +
Supply -ve	3	→	1	Supply -

#### 4.3.3.2 WindObserver

WindObserver					WindDisplay	
Signal Names	19 Way Connector	Cable Gland			Pin No.	Signal Name
	Pin No.	Pair No	Colour			
TXB(+)	P	1	Green	→	8	RS422 in +
TXA(-)	C	1	Black	→	7	RS422 in -
Sensor +	R	3	Red	→	2	Supply +
Sensor -	D	3	Black	→	1	Supply -
Connected Internally					Ground Earth	

### 4.3.4 Daisy Chain Connections

The daisy-chain output is used to transmit wind data to a second WindDisplay. The cable length depends on the type of cable used but a distance of up to 1000 metres is possible. The cable should be a twisted pair, screened and the screen should be grounded at one point only.

Anemometer		WindDisplay 1	
TXD +	→	8	RS422 in +
TXD-	→	7	RS422 in -
Supply +ve	→	2	Supply +
Supply -ve	→	1	Supply -
		9	Daisy Chain Out -
		10	Daisy Chain Out +
		WindDisplay 2	
	→	8	RS422 in +
	→	7	RS422 in -



#### 4.3.5 RS232 PC Connection

The Wind Display can be connected to a PC to confirm/change any settings via a 9-way D-type to D-type null modem cable

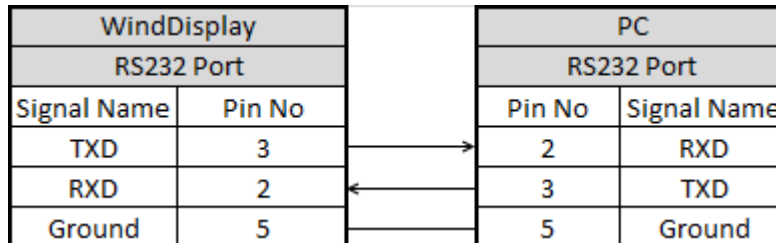

## 5 Commissioning

### 5.1 Anemometer Settings

The anemometer must be configured in the following output formats, depending on the type of WindDisplay required:-

**Gill ASCII Output**      1Hz (P1), Baud Rate 9600 (B3), Polar Cont (M2)  
**NMEA Output**            1Hz (P1), Baud Rate 4800 (B2), NMEA Cont (M5)

**For those users that have a display set for 9600 baud, NMEA sensor settings will be :-**  
**NMEA Output**            1Hz (P1), Baud Rate 9600 (B3), NMEA Cont (M5)

### 5.2 Display Tests

Before switching on the mains, check that the power supply is correct as indicated on the identification label on the rear of the equipment.

With no anemometer cable connected, switch on the display and observe the front panel LEDs. The system will perform an LED test. All LEDs are switched on and off one by one. When the test is finished the display shows no information on the LED circle and on speed and gust displays “- - -” is shown.

Connect the anemometer (if the anemometer is not connected the 15 Volt dc supply will cycle ON/OFF every 10 seconds).

Check the voltage at terminal (1) and (2) on the rear panel. This should be 15 Volts dc.

### 5.3 System Test

Connect the anemometer to the display as shown below:

#### Electrical Connections

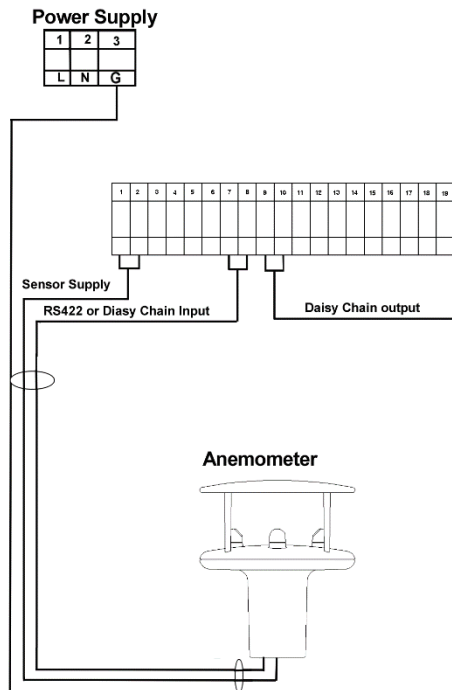

When both the anemometer and display are powered on wind speed data should be read on the 3 digit speed display and direction data indicated by the outer circles of LED's. The information update rate will be once per second.

### 5.4 Settings via the front panel

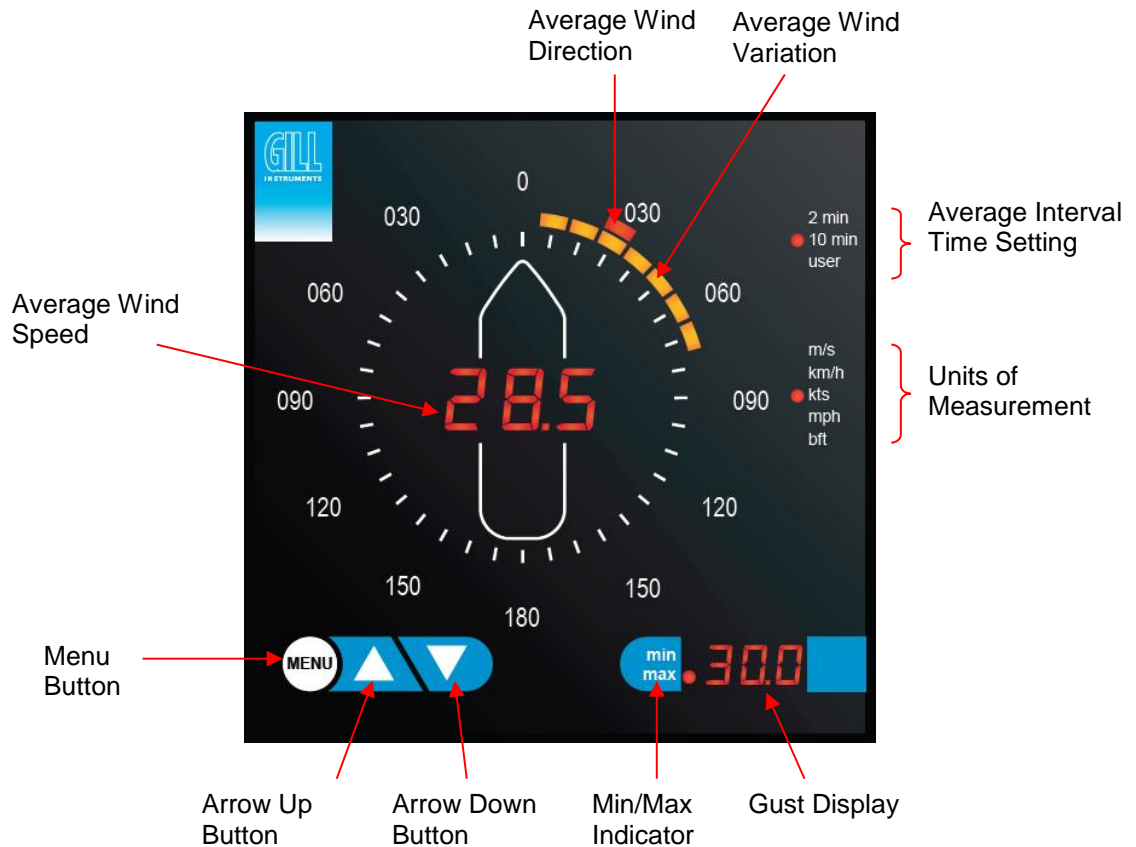

On the front panel of the display there are three push buttons, “MENU” “▲”and “▼”. An explanation of front panel button functions is as follows:-

#### 5.4.1 Brightness Control

To adjust the display brightness press the ▲ button to increase brightness or the ▼ button to decrease brightness. See also Para 5.6 for remote dimming.

#### 5.4.2 Min - Max Wind (Gust) Speed Indication

Press the Menu button once.  
The Max LED will start flashing.  
The Gust display will show the minimum wind speed over the selected interval.  
After 30 seconds the display will switch back to read the Maximum wind speed.

#### 5.4.3 Average Interval Settings

Press the Menu button twice.  
The LED in the “Average Interval Time” window starts to flash indicating that the selected option is functioning.  
Select the required Averaging Interval using the ▲ button or the ▼ button.  
If the buttons are not touched for 10 seconds, the display will return to the normal operating mode.

#### User (Averaging Off)

The inner circle of amber/orange LED's (multiple LED's illuminated) displays the movement of wind direction between the last direction reading and the new reading.

The outer circle of red LED's (single LED illuminated) displays the averaged reading of wind direction between the last and new reading seen on the Orange LED's.

The centre red numeric speed display indicates instantaneous speed.

#### 2/10 min Averaging On

The inner circle of amber/orange LED's (multiple LED's illuminated) displays the wind direction variation over the last 2/10mins.

The outer circle of red LED's (single illuminated) displays the average reading of wind direction over the last 2/10 minutes.

The centre red numeric speed display does not indicate instantaneous speed but displays an average reading over the last 2/10 minutes.

### **5.4.4 Units of Measurement**

Press the Menu button 3 times.

The LED in the Unit Selection window will start flashing.

Select the required units of measurement by pressing the ▲ or ▼ buttons.

If the buttons are not touched for 10 seconds, the display will return to the normal operating mode.

### **5.4.5 LED Test**

To undertake an LED test press both Arrow buttons (▲ ▼) simultaneously and all the display LEDs start flashing.

### **5.4.6 Gust Reading Reset (when in user average mode)**

To reset the Gust reading at the bottom right hand on the display, press the Menu and the Arrow Down (▼) button at the same time.

### **5.4.7 Wind Direction Offset Setting**

The display provides the possibility to add an offset to the wind direction. This is very useful for wind systems installed on oil rigs and for airports if they want to use the magnetic North instead of true North.

An offset is added in the following way. Press the arrow-up button (▲) and the menu button simultaneously. The Gust display starts flashing and is showing the offset. As long as the display is flashing, the offset can be changed using the arrow up or arrow down buttons (▲ ▼). The set value is added to the actual wind information from the anemometer.

## **5.5 Settings via PC**

It is also possible to configure the Wind Display via a terminal program (such as Tera Term or HyperTerm) using a simple menu system.

In order to use this option, the Wind Display will need to be connected to a PC via a null modem cable as per section 4.3.5.

With the Wind Display powered up and connected to the PC, start the terminal software. The default Baud rate the display uses is 9600.

Type 'MENU' (caps on) to display the main menu:

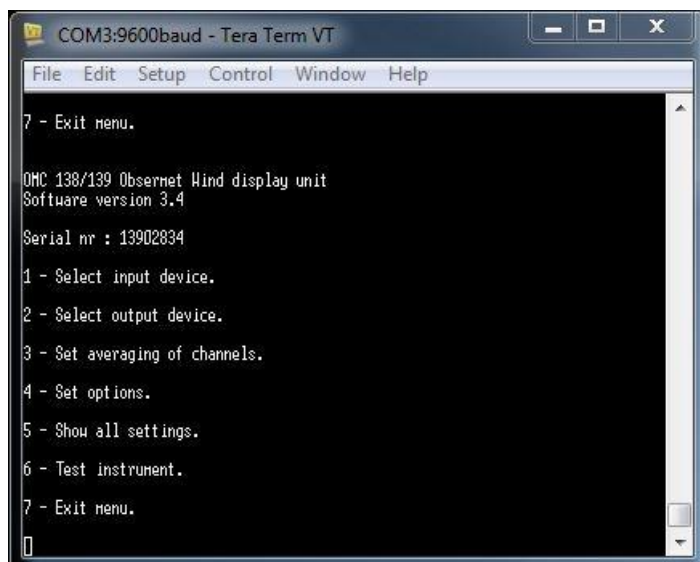

From here, the settings of the display can be edited as required or all the settings can be seen in full by selecting option 5:

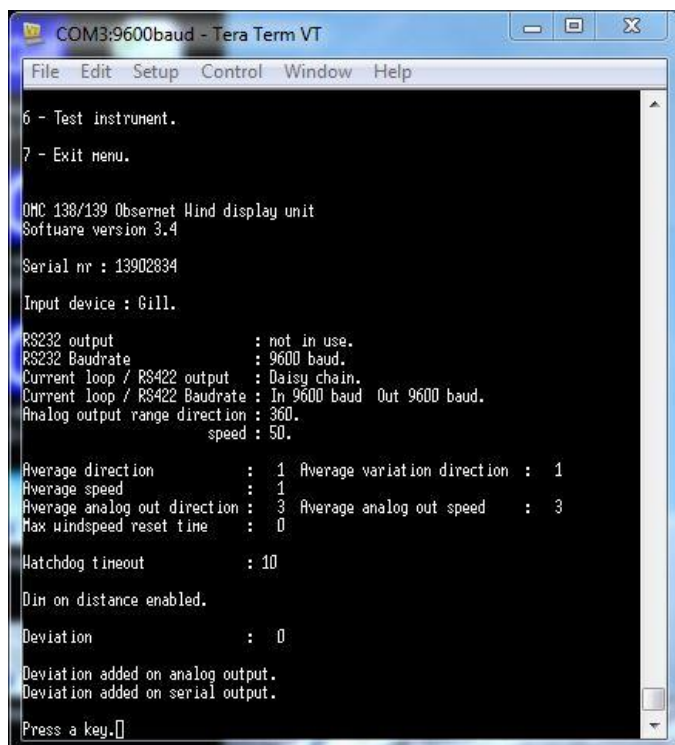

To change the input device from an anemometer configured for Gill output mode, 9600 Baud to a device configured for NMEA mode, 4800 Baud, follow the steps below:

From the main menu, press 1 to select Input Device and the following sub-menu should appear:

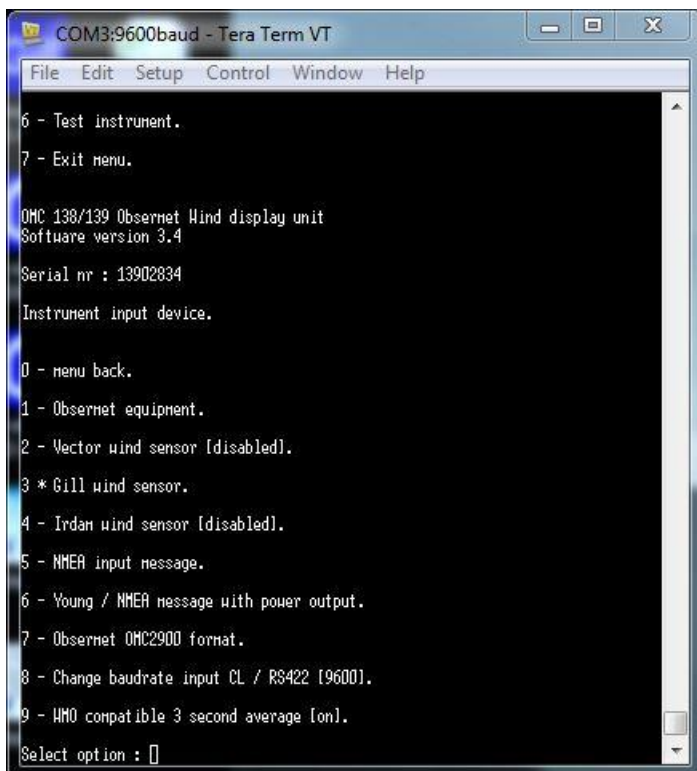

Select option 6 'Young/NMEA message with power output' (selecting option 5 will not enable the power output of the display)::

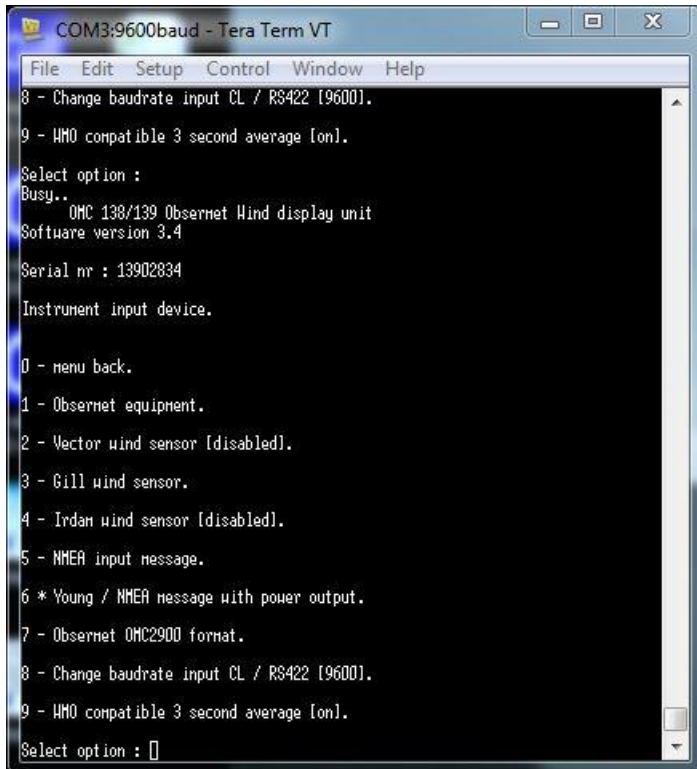

The asterisk denoting which option is selected will now be located next to option 6, rather than option 3.

Select option 8 'Change baudrate input CL / RS422 [9600].' The following sub-menu will appear:

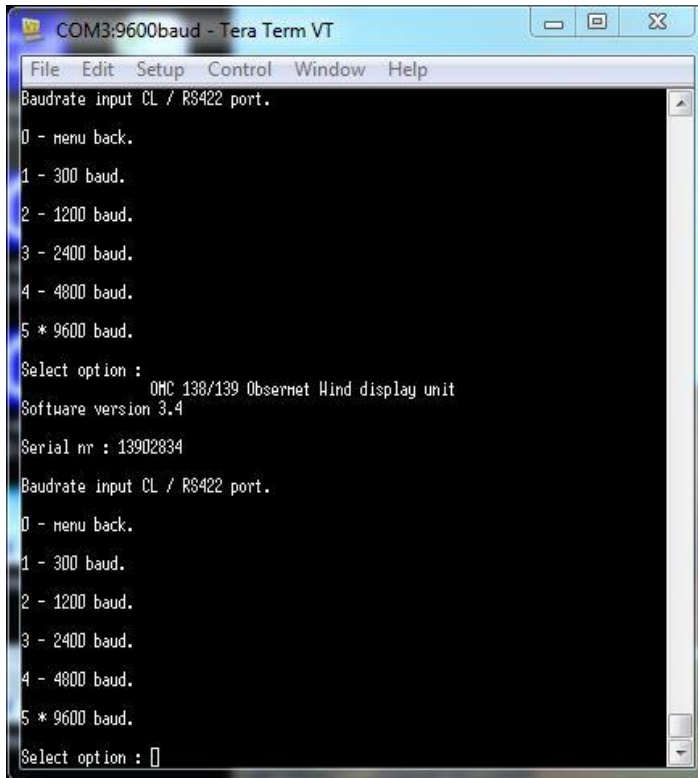

Select option 4:

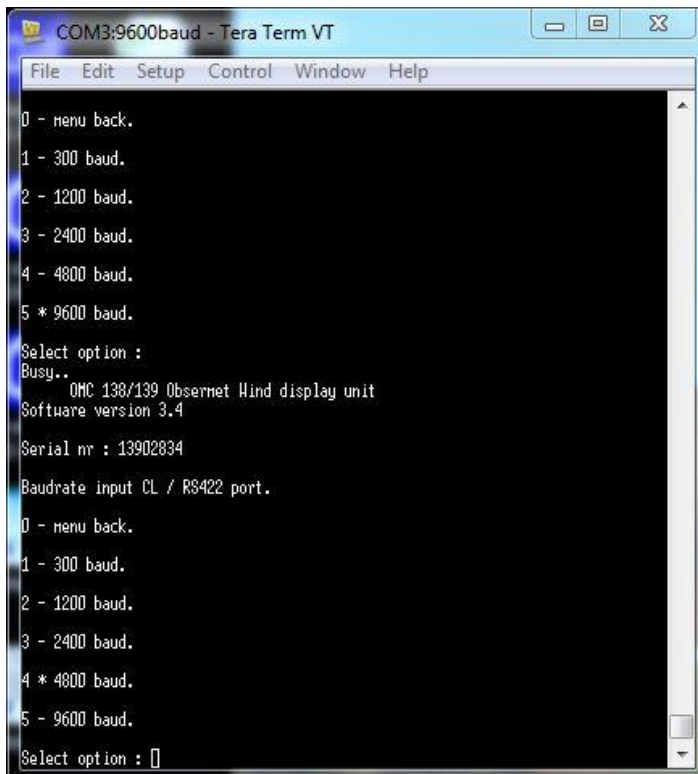

Press 0 twice to go back to the main menu, then select option 2 'Select Output Device':

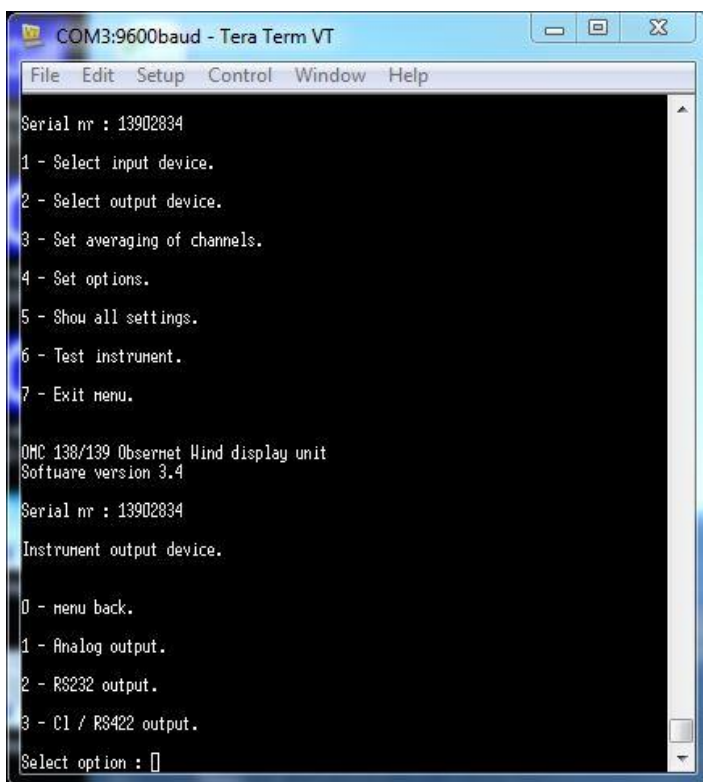

Then select option 3 'CI/RS422 output':

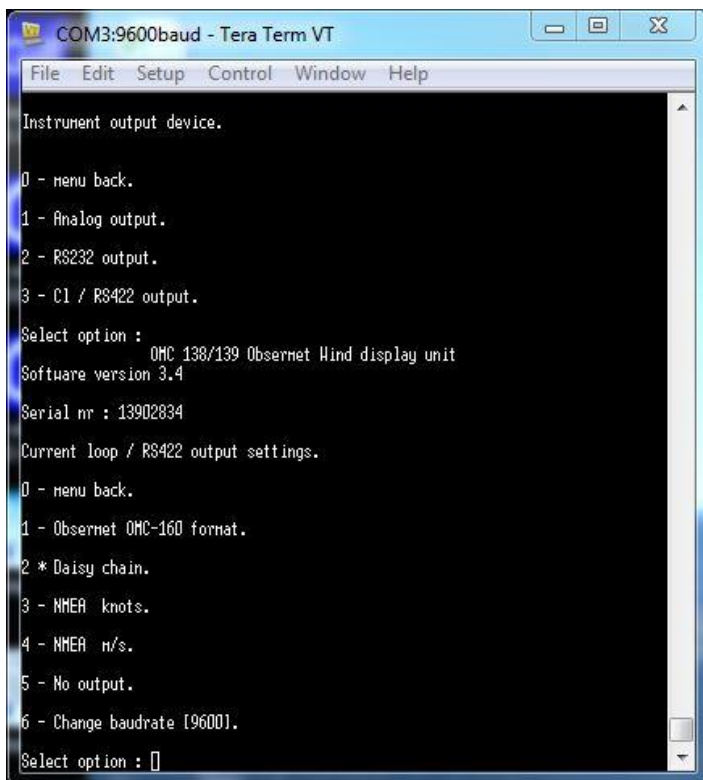



Select option 6 'Change Baud rate':

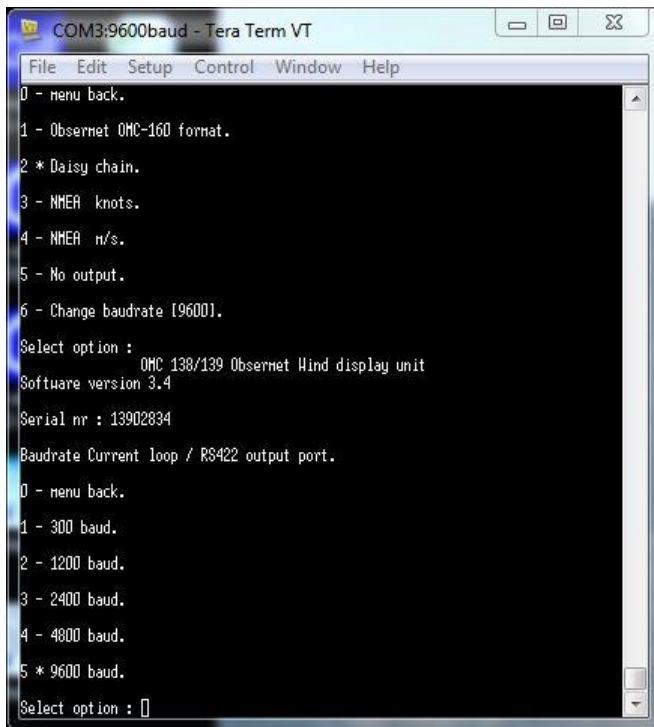

Select option 4 '4800 Baud':

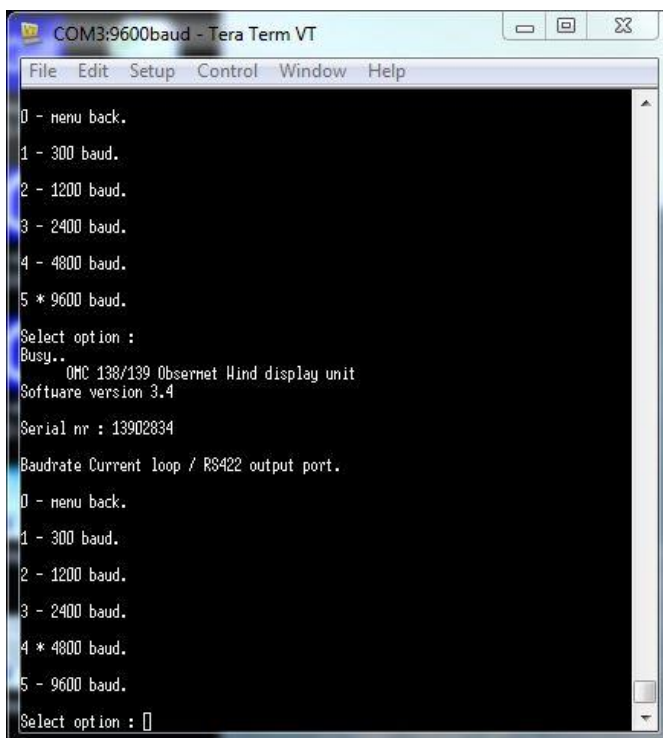

Once done, press '0' 3 times to return to the main menu. The settings can then be checked by selecting option 5 'show all settings' to ensure that they have been successfully changed:

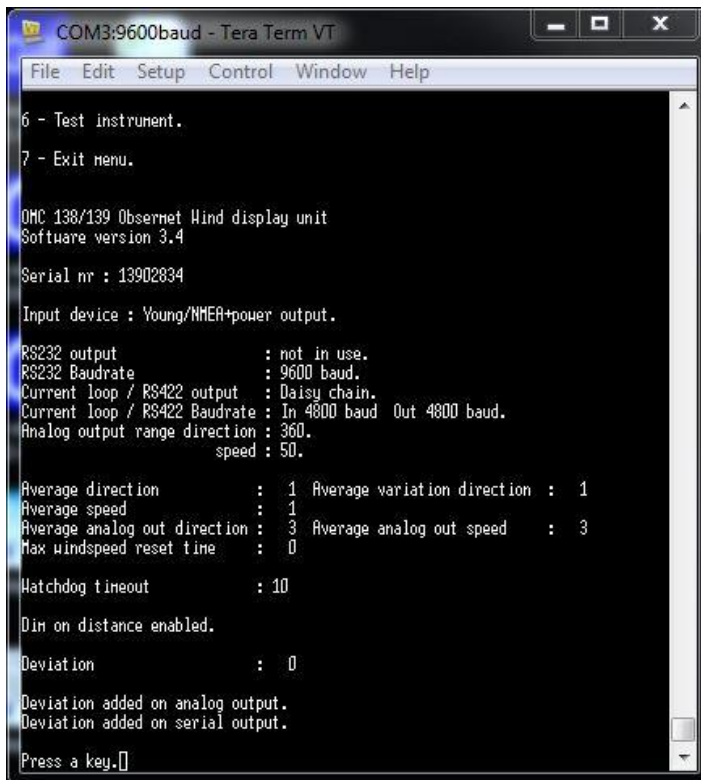

```
COM3:9600baud - Tera Term VT
File Edit Setup Control Window Help
6 - Test instrument.
7 - Exit menu.

OHC 138/139 Obsermet Wind display unit
Software version 3.4
Serial nr : 13902834
Input device : Young/MHEA+power output.

RS232 output      : not in use.
RS232 Baudrate    : 9600 baud.
Current loop / RS422 output : Daisy chain.
Current loop / RS422 Baudrate : In 4800 baud Out 4800 baud.
Analog output range direction : 360.
                                speed : 50.

Average direction      : 1 Average variation direction : 1
Average speed         : 1
Average analog out direction : 3 Average analog out speed : 3
Max windspeed reset time : 0

Watchdog timeout      : 10

Dim on distance enabled.

Deviation             : 0

Deviation added on analog output.
Deviation added on serial output.

Press a key.
```

## 5.6 Dimming Display Remotely (Option)

An optional push button switch can be purchased that allows for dimming of the Wind Display from a remote location.  
(Gill Instruments part number 018-03657).

Connections details are illustrated in Appendix 6.

## 5.7 Analogue Outputs (Option)

Analogue outputs are available as an option when ordering a display. (Wind Speed and Direction analogue outputs can be configured on request for 0-1V or 4-20mA levels and scaled from between 0-5m/s to 0-90m/s and 0-359°).

## 5.8 Fault Finding

When there is no serial information received from the anemometer, the watchdog circuit in the display unit starts to switch the 15 Volt supply voltage to the sensor ON and OFF. The supply voltage is on for 10 seconds and if no information is received from the anemometer, the supply voltage is switched OFF for 5 seconds. If this occurs during commissioning, check the wiring to the anemometer.

When the display is fully operational and the sensor information is not received for more than 5 seconds, the display starts to flash indicating that sensor information is no longer being received by the display unit.

If the wind direction readings are thought to be incorrect check to see whether a direction offset has been added with reference to Para 5.4.7. Otherwise check the mounting of the Wind Sensor to ensure that the north marker points to North or the ships bow as appropriate.

## 6 Maintenance

The Gill WindDisplay unit has no moving parts and requires no routine maintenance. In the event of failure, the unit must be returned to the authorised Gill Distributor.

**HAZARD WARNING! EXPOSED LIVE VOLTAGES ON REAR TERMINALS. ENSURE WindDisplay IS DISCONNECTED FROM MAINS BEFORE ACCESSING REAR PANEL!**

If required, the front panel of the display can be cleaned with a cloth, slightly moistened with a soft detergent. Ensure that no liquid enters the display unit. Solvents should not be used and care should be taken to avoid scratching the front panel.

**Fuses: Glass fuses 5 x 20 mm anti-surge type**  
**250V T40mA for 230V AC**  
**250V T80mA for 115V AC**  
**250V T250mA for 24V DC**

The fuse can be reached as follows:-

Switch off the main supply and disconnect all the wiring on the rear of the display.  
Remove the four 2.5mm screws on the rear of the display.  
Remove the front window, pull on a corner with both hands.  
Hold the front of the unit down and remove the whole case.  
The fuse is positioned on the PCB see **Appendix 5**.

## 7 Appendix/Drawings

Appendix 1	General assembly
Appendix 2	Cable information
Appendix 3	Electrical connections
Appendix 4	Daisy chain connections
Appendix 5	Rear view of WindDisplay

### 7.1 ELECTRICAL CONFORMITY STATEMENT

The products covered in this manual are in conformity with the directive 89/336/EEC based on test results using the harmonized standard EN 60945 in accordance with Article 10 (1) of the directive

These products are in conformity with the directive 73/23/EEC and 93/68/EEC

**APPENDIX 1 – General Assembly**

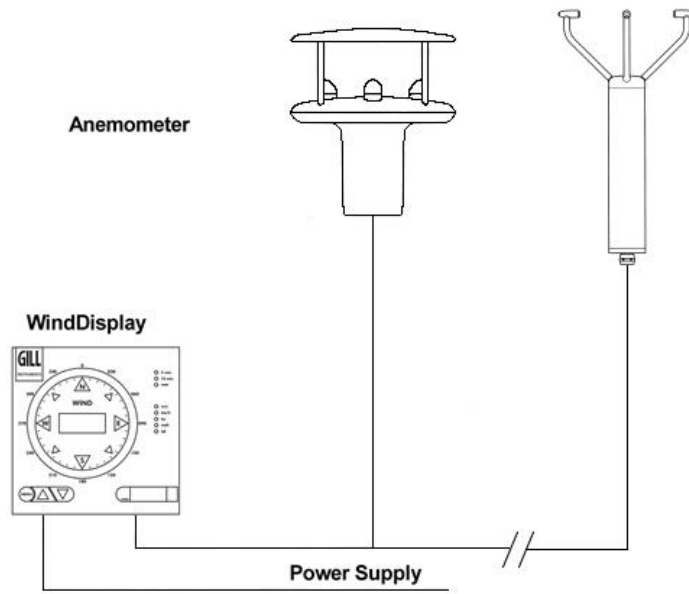

**APPENDIX 2 – Cable information**

**Cable Information**

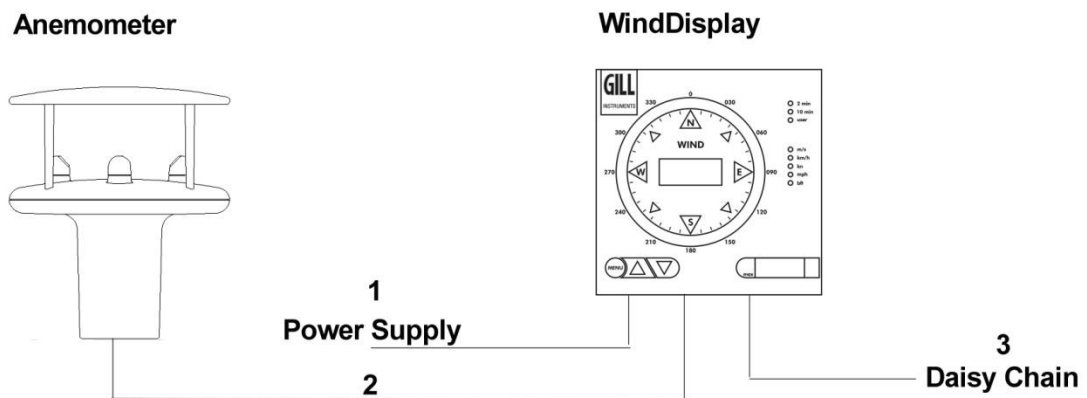

- 1 = 3 core mains cable 1.00 mm<sup>2</sup> 10A rating
- 2 = 2 Twisted pairs RS422 compatible 7/0.2 (Screened)
- 3 = 1 Twisted pair 7/0.2 RS422 compatible (Screened)

**APPENDIX 3 – Electrical connections**

**Electrical Connections**

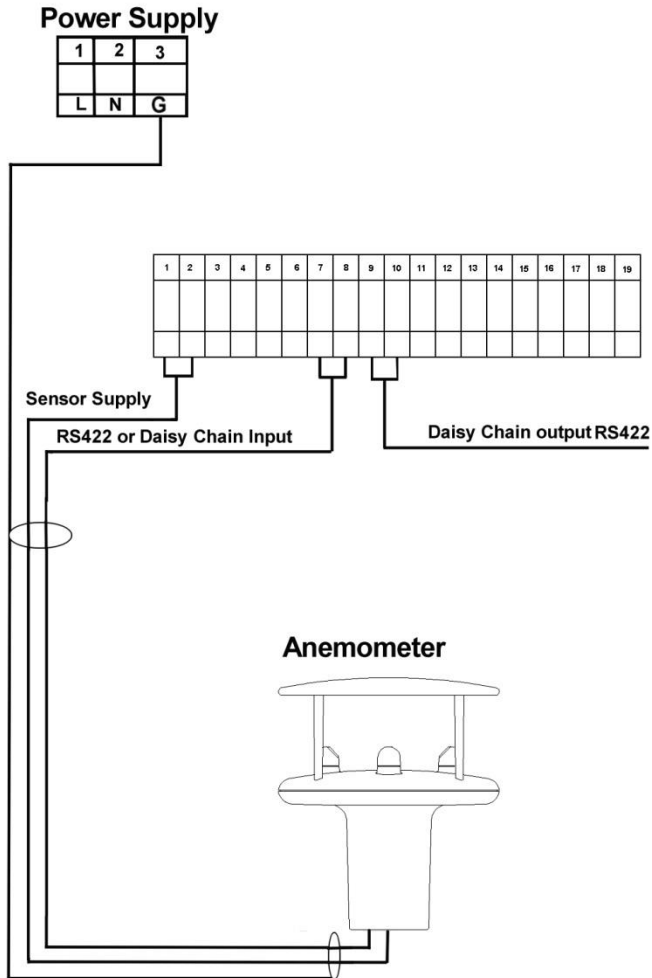

### APPENDIX 4 – Daisy chain connections

#### Daisy Chain Connections

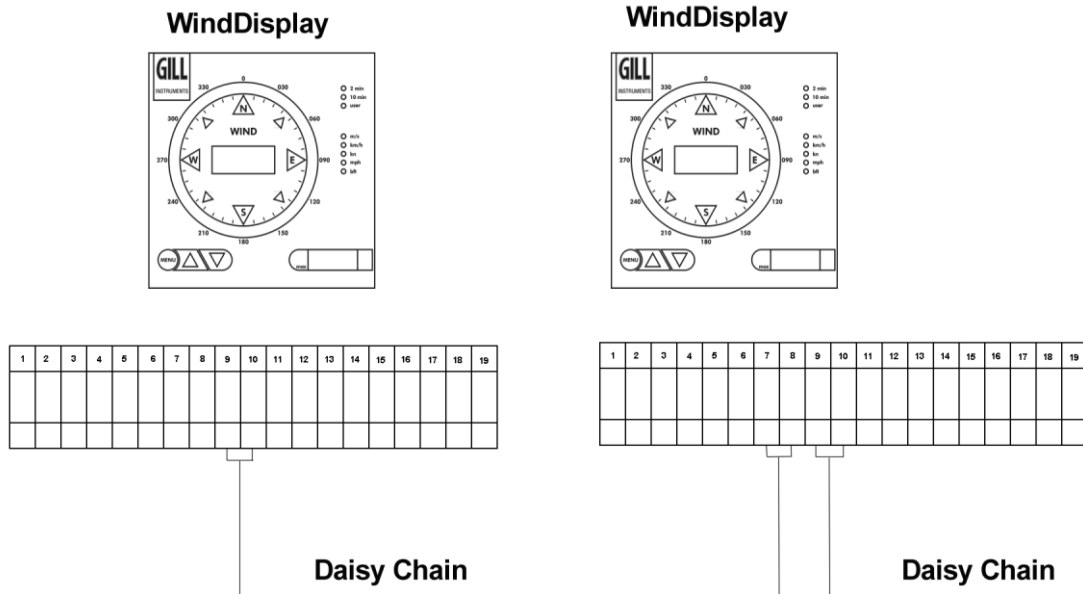

### APPENDIX 5 – Rear view of WindDisplay

#### Rear Side of Display

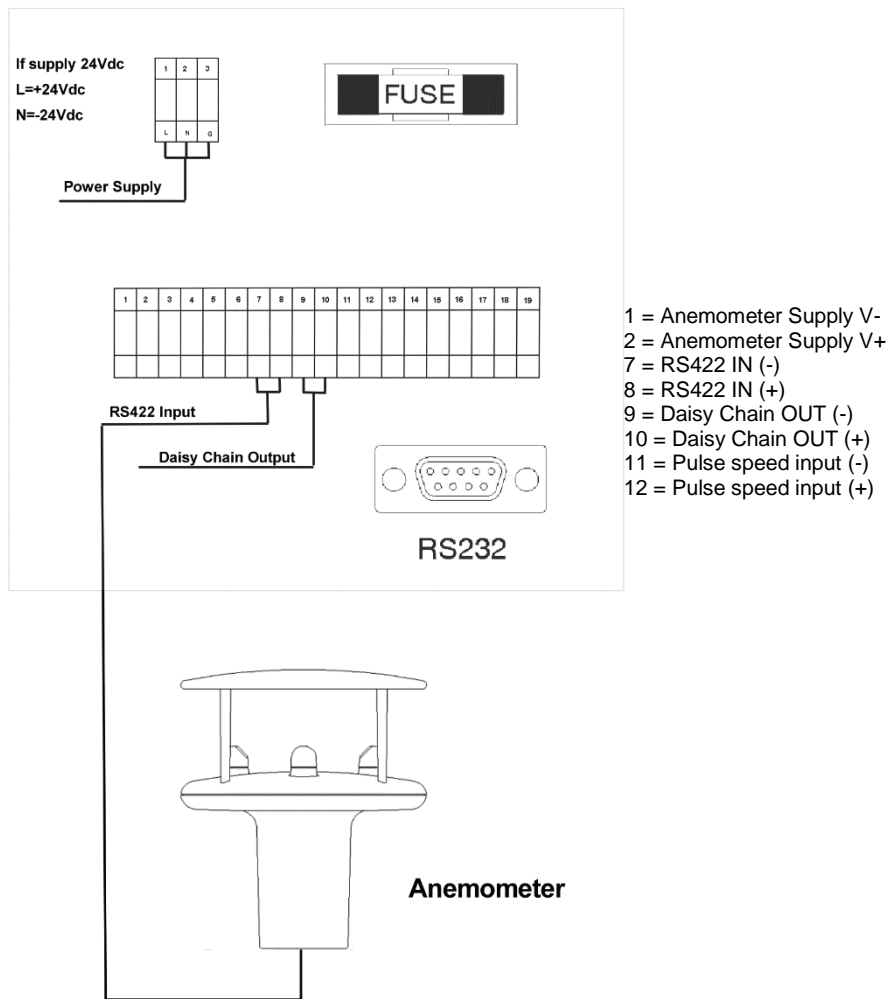

### APPENDIX 6 - WindDisplay Dimmer Switch Connection

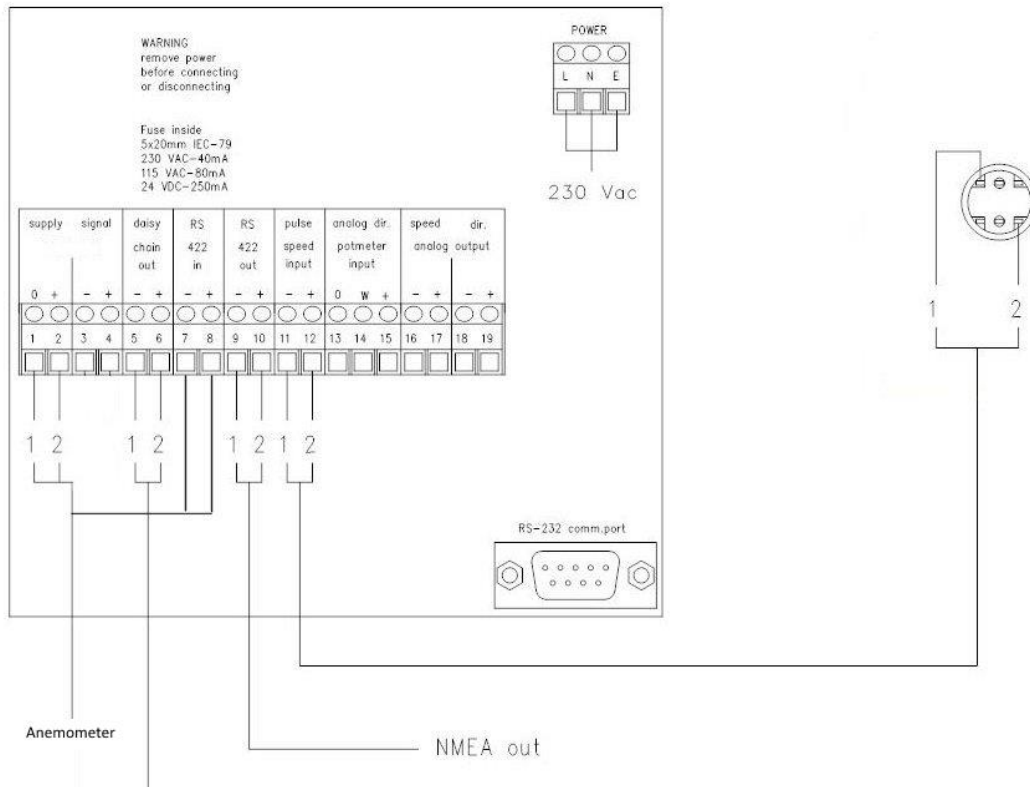

### APPENDIX 7 - Dimmer Switch Dimensions

