

# USER MANUAL

## **HFP01 & HFP03**

Heat flux plate / heat flux sensor



## Warning statements



Putting more than 12 Volt across the sensor wiring can lead to permanent damage to the sensor.



Do not use “open circuit detection” when measuring the sensor output.

# Contents

<b>Warning statements</b>	<b>2</b>
<b>Contents</b>	<b>3</b>
<b>List of symbols</b>	<b>4</b>
<b>Introduction</b>	<b>5</b>
<b>1 Ordering and checking at delivery</b>	<b>8</b>
1.1 Ordering HFP01	8
1.2 Included items	8
1.3 Quick instrument check	8
<b>2 Instrument principle and theory</b>	<b>9</b>
<b>3 Specifications of HFP01</b>	<b>11</b>
3.1 Specifications of HFP01	11
3.2 Dimensions of HFP01	14
<b>4 Standards and recommended practices for use</b>	<b>15</b>
4.1 Heat flux measurement in building physics	15
4.2 Heat flux measurement in meteorology	19
<b>5 Installation of HFP01</b>	<b>22</b>
5.1 Site selection and installation in building physics	22
5.2 Site selection and installation in meteorology / the soil	25
5.3 Electrical connection	26
5.4 Requirements for data acquisition / amplification	28
<b>6 Making a dependable measurement</b>	<b>29</b>
6.1 Uncertainty evaluation	29
6.2 Typical measurement uncertainty budget	30
6.3 Contributions to the uncertainty budget	30
<b>7 Maintenance and trouble shooting</b>	<b>34</b>
7.1 Recommended maintenance and quality assurance	34
7.2 Trouble shooting	35
7.3 Calibration and checks in the field	36
<b>8 HFP03</b>	<b>37</b>
8.1 Introduction HFP03	37
<b>9 Appendices</b>	<b>40</b>
9.1 Appendix on cable extension / replacement	40
9.2 Appendix on standards for calibration	41
9.3 Appendix on calibration hierarchy	41
9.4 Appendix on using HFP01 with BLK – GLD sticker series	42
9.5 EU declaration of conformity	43

## List of symbols

### Quantities

Heat flux  
 Voltage output  
 Sensitivity  
 Temperature  
 Temperature difference  
 Time constant  
 Thermal resistance per unit area  
 $\Lambda$ -Value, thermal conductance  
 Thermal resistance per unit area,  
 including ambient air boundary layer resistances  
 U-Value, thermal transmittance  
 Time  
 Thermal conductivity  
 Thermal resistivity  
 Ambient air / wind speed  
 Volumic heat capacity  
 Resistance  
 Heat transfer coefficient  
 Convection heat transfer coefficient  
 Radiation heat transfer coefficient  
 Storage term  
 Thermal conductivity dependence  
 Depth of installation  
 Water content (on mass basis)

Symbol	Unit
$\Phi$	W/m <sup>2</sup>
U	V
S	V/(W/m <sup>2</sup> )
T	°C
$\Delta T$	°C, K
$\tau$	s
$R_{\text{thermal,A}}$	K/(W/m <sup>2</sup> )
$\Lambda$	W/(m <sup>2</sup> ·K)
$R_{\text{thermal,A,B}}$	K/(W/m <sup>2</sup> )
U	W/(m <sup>2</sup> ·K)
t	s
$\lambda$	W/(m·K)
r	m·K/W
V	m/s
$c_{\text{volumic}}$	J/(m <sup>3</sup> ·K)
R	$\Omega$
h	W/(m <sup>2</sup> ·K)
$h_c$	W/(m <sup>2</sup> ·K)
$h_r$	W/(m <sup>2</sup> ·K)
S	W/m <sup>2</sup>
$D_\lambda$	%/(W/(m·K))
x	m
Q	kg/kg

### Subscripts

property of thermopile sensor  
 property of ambient air  
 calibration reference condition  
 property of the object on which HFP01 is mounted  
 property at the (wall or soil) surface  
 property at indoor location  
 property at outdoor location  
 property of the surrounding environment

sensor  
 ambient  
 reference  
 object  
 surface  
 indoor  
 outdoor  
 environment

## Introduction

HFP01 is the world's most popular sensor for heat flux measurement in the soil as well as through walls and building envelopes. The total thermal resistance is kept small by using a ceramics-plastic composite body. The sensor is very robust and stable. It is suitable for long term use on one location as well as repeated installation when a measuring system is used at multiple locations.

HFP03 is the high-sensitivity version of HFP01. It differs in sensor technology and has a larger size. The sensor working principle and considerations for use are the same. **This manual is written for model HFP01, but most content is applicable to HFP03 as well. HFP03 has a dedicated chapter in this manual focusing on the differences between HFP03 and HFP01.**

HFP01 measures heat flux through the object in which it is incorporated or on which it is mounted, in  $W/m^2$ . The sensor in HFP01 is a thermopile. This thermopile measures the temperature difference across the ceramics-plastic composite body of HFP01. A thermopile is a passive sensor; it does not require power. Using HFP01 is easy. It can be connected directly to commonly used data logging systems. The heat flux,  $\Phi$ , in  $W/m^2$ , is calculated by dividing the HFP01 output, a small voltage  $U$ , by the sensitivity  $S$ .

The measurement function of HFP01 is:

$$\Phi = U/S \quad \text{(Formula 0.1)}$$

The sensitivity is provided with HFP01 on its product certificate.



**Figure 0.1** HFP01 heat flux plate / sensor. The opposite side has a blue coloured cover.

A typical measurement location is equipped with 2 heat flux sensors for good spatial averaging. If the sensitivity of a single sensor is too low, two or more sensors can electrically be put in series, creating an amplified single output signal.

HFP01 can be used for on-site measurement of building envelope thermal resistance per unit area (R-value) and thermal transmittance (U-value) according to the standardised practices of ISO 9869, ASTM C1046 and ASTM 1155.

Equipped with heavy duty cabling, protective covers at both sides and potted so that moisture does not penetrate the sensor, HFP01 has proven to be very robust and stable. It survives long-term installation in soils, as well as repeated installation when a measuring system such as TRSYS01 is used at multiple locations.

Suggested use of HFP01:

- building heat flux
- U-value and R-value measurements
- soil heat flux



**Figure 0.2** HFP01. The opposite side has a red coloured cover. Standard cable length is 5 m.

The uncertainty of a measurement with HFP01 is a function of:

- calibration uncertainty
- differences between reference conditions during calibration and measurement conditions, for example uncertainty caused by temperature dependence of the sensitivity
- the duration of sensor employment (involving the non-stability)
- application errors: the measurement conditions and environment in relation to the sensor properties, the influence of the sensor on the measurand, the representativeness of the measurement location

The user should make his own uncertainty evaluation. Detailed suggestions for experimental design and uncertainty evaluation can be found in the following chapters.

HFP01 calibration is traceable to international standards. The factory calibration method follows the recommended practice of ASTM C1130. The recommended calibration interval of heat flux sensors is 2 years.

Would you like to study energy transport / heat flux in detail? Hukseflux helps taking this measurement to the next level: order HFP01 with radiation-absorbing black and radiation-reflecting gold stickers. You can then measure convective + radiative flux with one, and convective flux only with the other. Subtract the 2 measurements and you have radiative flux. They can be applied to the sensor by the user or ordered pre-applied at the factory; see the BLK – GLD sticker series user manual and installation video for instructions.



**Figure 0.3** HFP01 heat flux plate: with BLK-80 and GLD-80 stickers to measure radiative and convective heat fluxes separately

See also:

- if measuring in soil, in case a high level quality assurance and accuracy of the measurement is needed, consider use of model [HFP01SC](#).
- model HFP03 for increased sensitivity; an alternative is putting two or more HFP01's electrically in series. HFP03 specifications can be found in a dedicated chapter of this manual.
- [BLK - GLD sticker series](#) to separate radiative and convective heat fluxes
- view our complete [product range of heat flux sensors](#).
- view the [TRSYS01](#) building thermal resistance measuring system which includes 2 x HFP01 and 4 x matched thermocouples type K.

# 1 Ordering and checking at delivery

## 1.1 Ordering HFP01

The standard configuration of HFP01 is with 5 metres cable.

Common options are:

- longer cable in multiples of 5 m, cable lengths above 20 m in multiples of 10 m. specify total cable length.
- BLK-80 black sticker (to measure radiative as well as convective heat flux)
- GLD-80 gold sticker (to measure convective heat flux only)
- BLK - GLD sticker series can also be ordered pre-applied at the factory

## 1.2 Included items

Arriving at the customer, the delivery should include:

- heat flux sensor HFP01
- cable of the length as ordered
- product certificate matching the instrument serial number

## 1.3 Quick instrument check

A quick test of the instrument can be done by connecting it to a multimeter.

1 Check the electrical resistance of the sensor between the green [-] and white [+] wires. Use a multimeter at the 100  $\Omega$  range. Measure the sensor resistance first with one polarity, then reverse the polarity. Take the average value. The typical resistance of the wiring is 0.1  $\Omega$ /m. Typical resistance should be the nominal sensor resistance of 2  $\Omega$  for plus 1.5  $\Omega$  for the total resistance of two wires (back and forth) of each 5 m. Infinite resistance indicates a broken circuit; zero or a lower than 1  $\Omega$  resistance indicates a short circuit.

2. Check if the sensor reacts to heat: put the multimeter at its most sensitive range of DC voltage measurement, typically the 100 x 10<sup>-3</sup> VDC range or lower. Expose the sensor heat, for instance touching it with your hand. The signal should read > 2 x 10<sup>-3</sup> V now. Touching or exposing the red side should generate a positive signal, doing the same at the opposite side the sign of the output voltage reverses.

3. Inspect the instrument for any damage.

4. Check the sensor serial number and sensitivity on the 2 x cable labels (one at sensor end, one at cable end) against the certificate provided with the sensor.



## 2 Instrument principle and theory

HFP01's scientific name is heat flux sensor. A heat flux sensor measures the heat flux density through the sensor itself. This quantity, expressed in  $W/m^2$ , is usually called "heat flux".

HFP01 users typically assume that the measured heat flux is representative of the undisturbed heat flux at the location of the sensor. Users may also apply corrections based on scientific judgement.

The sensor in HFP01 is a thermopile. This thermopile measures the temperature difference across the ceramics-plastic composite body of HFP01. Working completely passive, the thermopile generates a small voltage that is a linear function of this temperature difference. The heat flux is proportional to the same temperature difference divided by the effective thermal conductivity of the heat flux sensor body. Using HFP01 is easy. For readout the user only needs an accurate voltmeter that works in the millivolt range. To convert the measured voltage,  $U$ , to a heat flux  $\Phi$ , the voltage must be divided by the sensitivity  $S$ , a constant that is supplied with each individual sensor.

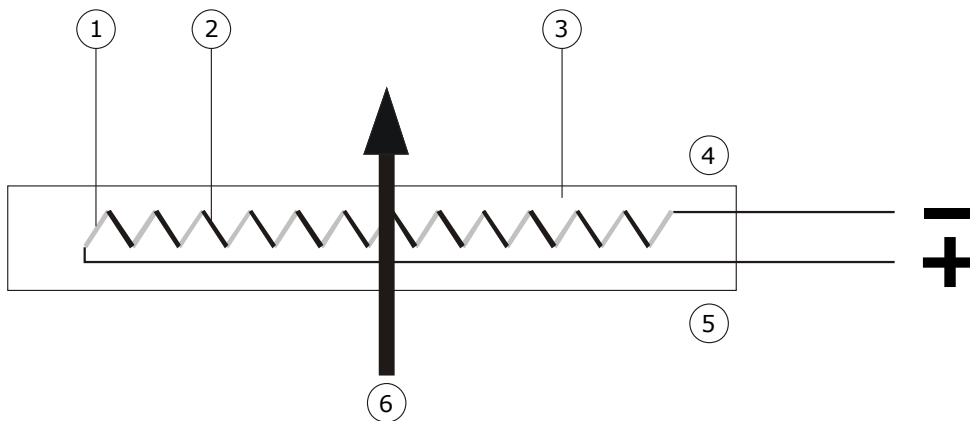

**Figure 2.1** The general working principle of a heat flux sensor. The sensor inside HFP01 is a thermopile. A thermopile consists of a number of thermocouples, each consisting of two metal alloys (marked 1 and 2), electrically connected in series. A single thermocouple generates an output voltage that is proportional to the temperature difference between its hot- and cold joints. Putting thermocouples in series amplifies the signal. In a heat flux sensor, the hot- and cold joints are located at the opposite sensor surfaces (4 and 5). In steady state, the heat flux (6) is a linear function of the temperature difference across the sensor and the average thermal conductivity of the sensor body (3). The thermopile generates a voltage output proportional to the heat flux through the sensor. The exact sensitivity of the sensor is determined at the manufacturer by calibration, and can be found on the product certificate that is supplied with each sensor.

Heat flux sensors such as HFP01, for use in the soil and on building envelopes, are typically calibrated under the following reference conditions:

- conductive heat flux (as opposed to radiative or convective heat flux)
- homogeneous heat flux across the sensor and guard surface
- room temperature
- heat flux in the order of 350 W/m<sup>2</sup>

Unique features of HFP01 are:

- low thermal resistance (essential for use on walls and windows)
- large guard area (required by the ISO 9869 standard)
- low electrical resistance (low pickup of electrical noise)
- high sensitivity (good signal to noise ratio in low-flux environments such as buildings)
- robustness, including a strong cable
- IP protection class: IP67 (essential for outdoor application)

Measuring with heat flux sensors, errors may be caused by differences between calibration reference conditions and the conditions during use. The user should analyse his own experiment and make his own uncertainty evaluation. Comments on the most common error sources can be found in the chapter about uncertainty evaluation.

## 3 Specifications of HFP01

### 3.1 Specifications of HFP01

HFP01 measures the heat flux density through the surface of the sensor. This quantity, expressed in  $W/m^2$ , is called heat flux. Working completely passive, using a thermopile sensor, HFP01 generates a small output voltage proportional to this flux. It can only be used in combination with a suitable measurement system. The sensor should be used in accordance with the recommended practices of ISO and ASTM.

**Table 3.1** Specifications of HFP01 (continued on next page)

<b>HFP01 SPECIFICATIONS</b>	
Sensor type	heat flux plate / heat flux sensor
Sensor type according to ISO 9869	heat flow meter
Sensor type according to ASTM	heat flow sensor or heat flux transducer
Measurand	heat flux
Measurand in SI units	heat flux density in $W/m^2$
Measurement range	-2000 to 2000 $W/m^2$
Sensitivity range	50 to 70 $\times 10^{-6}$ V/( $W/m^2$ )
Sensitivity (nominal)	60 $\times 10^{-6}$ V/( $W/m^2$ )
Directional sensitivity	heat flux from the red to the blue side generates a positive voltage output signal
Increased sensitivity	multiple sensors may be put electrically in series. The resulting sensitivity is the sum of the sensitivities of the individual sensors. Also see model HFP03
Expected voltage output	application in meteorology: -10 to +20 $\times 10^{-3}$ V application in building physics: -10 to +75 $\times 10^{-3}$ V turning the sensor from one side to the other will lead to a reversal of the sensor voltage output
Measurement function / required programming	$\Phi = U/S$
Required readout	1 x differential voltage channel or 1 single ended voltage channel, input resistance $> 10^6 \Omega$
Rated operating temperature range	-30 to +70 °C
Temperature dependence	$< 0.1 \%$ /°C
Non-stability	$< 1 \%$ /yr (for typical use in meteorology and building physics)
Thermal conductivity dependence	7 %/( $W/(m \cdot K)$ ) (order of magnitude only)
Sensor diameter including guard	80 $\times 10^{-3}$ m
Sensing area	8 $\times 10^{-4}$ m <sup>2</sup>
Sensing area diameter	32 $\times 10^{-3}$ m
Passive guard area	42 $\times 10^{-4}$ m <sup>2</sup> (a passive guard is required by ISO 9869)
Guard width to thickness ratio	5 m/m (as required by ISO 9869 D.3.1)
Sensor thickness	5.4 $\times 10^{-3}$ m
Sensor thermal resistance	71 $\times 10^{-4}$ K/( $W/m^2$ )
Sensor thermal conductivity	0.76 $W/(m \cdot K)$
Response time (95 %)	180 s
Sensor resistance range	1 to 4 $\Omega$
Required sensor power	zero (passive sensor)

**Table 3.1** Specifications of HFP01 (started on previous page, continued on the next page)

Standards governing use of the instrument	ISO 9869 Thermal insulation – Building elements – In-situ measurement of thermal resistance and thermal transmittance. ASTM C 1155-95 Standard Practice for Determining Thermal Resistance of Building Envelope Components from the In Situ Data. ASTM 1046-95 Standard Practice for In Situ Measurement of Heat Flux and Temperature on Building Envelope Components
Standard cable length (see options)	5 m
Wiring	0.15 m wires and shield at cable end
Cable diameter	$4 \times 10^{-3}$ m
Cable markers	2 x sticker, 1 x at sensor and 1 x cable end, wrapped around the heat flux sensor cable. Both stickers show sensitivity and serial number.
IP protection class	IP67
Rated operating relative humidity range	0 to 100 %
Gross weight including 5 m cable	approx. 0.5 kg
Net weight including 5 m cable	approx. 0.5 kg

**INSTALLATION AND USE**

Recommended number of sensors	2 per measurement location
Orientation	no preferred orientation
Installation	see recommendations in this user manual
Cable extension	see chapter on cable extension or order sensors with longer cable
Mounting with double sided tape	we recommend use of double-sided “removable” carpet laying tape such as TESA 4939, which has free removability up to 14 days from the most common surfaces (needs to be tested individually before usage)

**CALIBRATION**

Calibration traceability	to SI units
Production report	included (showing calibration result and traceability)
Calibration method	method HFPC01, according to ASTM C1130
Calibration hierarchy	from SI through international standards and through an internal mathematical procedure
Calibration uncertainty	< 3 % (k = 2) compliant with ISO 9869 requirement < 2 % (k = 1)
Recommended recalibration interval	2 years
Calibration reference conditions	20 °C, heat flux of 350 W/m <sup>2</sup> , thermal conductivity of the surrounding environment 0.0 W/(m·K)
Validity of calibration	based on experience the instrument sensitivity will not change during storage. During use the instrument “non-stability” specification is applicable
Field calibration	is possible by comparison to a calibration reference sensor. usually mounted side by side, alternatively mounted on top of the field sensor. Preferably reference and field sensor of the same model and brand. Typical duration of test > 24 h

**Table 3.1** Specifications of HFP01 (started on previous 2 pages)

<b>MEASUREMENT ACCURACY</b>	
Uncertainty of the measurement	statements about the overall measurement uncertainty can only be made on an individual basis. see the chapter on uncertainty evaluation
<b>VERSIONS / OPTIONS</b>	
Longer cable	in multiples of 5 m, cable lengths above 20 m in multiples of 10 m option code = total cable length
With black sticker applied	BLK-80 applied to the sensor at the factory to absorb radiation
With gold sticker applied	GLD-80 applied to the sensor at the factory to reflect radiation
<b>ACCESSORIES</b>	
Handheld read-out unit	LI19 programmed LI19 handheld read-out unit / datalogger, two spare batteries, one USB cable, software and a transport case
Separate black stickers	BLK-5050 to absorb radiation, to be applied by the user
Separate gold sticker	GLD-5050 to reflect radiation, to be applied by the user

### 3.2 Dimensions of HFP01

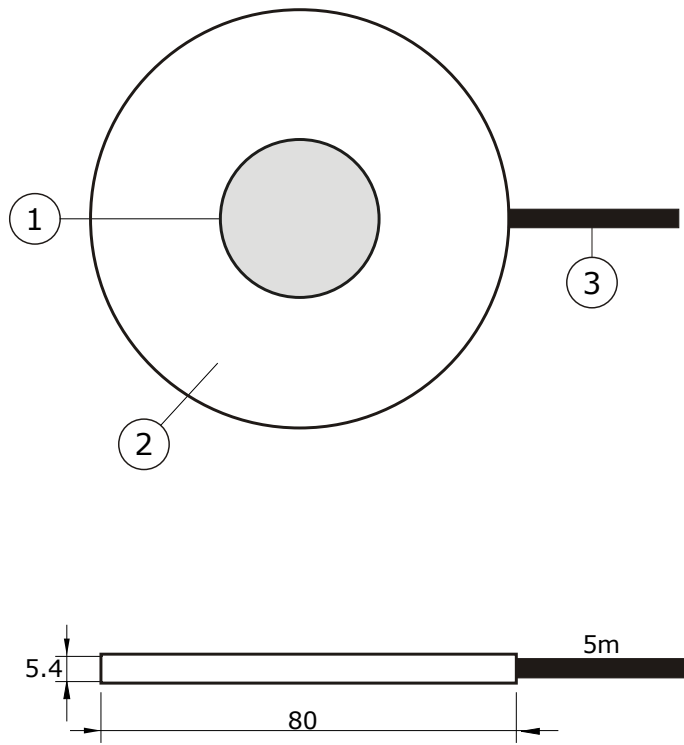

**Figure 3.2.1** HFP01 heat flux sensor dimensions in  $\times 10^{-3}$  m

- (1) sensing area
- (2) passive guard of ceramics-plastic composite
- (3) cable (standard length 5 m, optionally longer cable in multiples of 5 m, cable lengths above 20 m in multiples of 10 m.)

Total sensor thickness including covers is  $5.4 \times 10^{-3}$  m.

## 4 Standards and recommended practices for use

HFP01 should be used in accordance with the recommended practices of ISO and ASTM.

### 4.1 Heat flux measurement in building physics

Many HFP01 sensors measure heat flux in buildings, estimating the building's energy budget and thermal transmission of walls. Typically the total measurement system consist of multiple heat flux- and temperature sensors, sometimes combined with measurements of solar radiation, wind speed and wind direction.



**Figure 4.1.1** HFP01 heat flux sensors in use on a wall

Hukseflux offers a complete measurement system for analysis of building envelopes: **TRSYS01**.

Table 4.1.1.1 contains a listing of applicable standards. We recommend users to purchase the latest version of the standard.

#### 4.1.1 Applicable standards

**Table 4.1.1.1** *Standards with recommendations for instrument use in building physics*

<b>STANDARDS FOR INSTRUMENT USE FOR BUILDING ENVELOPE THERMAL RESISTANCE MEASUREMENT</b>	
ISO STANDARD	EQUIVALENT ASTM STANDARD
ISO 9869 Thermal insulation – Building elements – In-situ measurement of thermal resistance and thermal transmittance	<p>ASTM C 1155-95 Standard Practice for Determining Thermal Resistance of Building Envelope Components from the In Situ Data</p> <p>ASTM 1046-95 Standard Practice for In Situ Measurement of Heat Flux and Temperature on Building Envelope Components</p>

#### 4.1.2 ISO 9869 thermal conductance ( $\Lambda$ -value) and transmittance (U-value)

ISO 9869 may be applied both in “hot-box” steady state laboratory methods and in long-term averaging in field measurements. In this standard the heat flux sensor name is heat flow meter (HFM).

ISO 9869 makes a distinction between:

- thermal resistance  $R$  from surface to surface by conduction, calculated from heat flux and surface temperature difference (or the inverse value:  $\Lambda$ -Value or thermal conductance)
- thermal resistance  $R_T$  from environment to environment by convection plus conduction, calculated from heat flux and ambient air temperature difference (or the inverse value: U-value, or thermal transmittance)

At Hukseflux we typically measure the wall thermal conductance using surface temperatures on the wall:

$$\Lambda\text{-value} = 1/R_{\text{thermal,A}} = \Phi / (T_{\text{surface,indoor}} - T_{\text{surface,outdoor}}) \quad (\text{Formula 4.1.2.1})$$

The thermal resistance  $R_{\text{thermal,A}}$  of an old insulated wall is of the order of 2.5 K/(W/m<sup>2</sup>), a modern insulated wall may attain 6.7 K/(W/m<sup>2</sup>).

When measuring the thermal transmittance:

$$U\text{-value} = 1/R_{\text{thermal A,B}} \quad (\text{Formula 4.1.2.2})$$

The U-value includes  $R_{\text{ambient,indoor}}$  and  $R_{\text{ambient,outdoor}}$  thermal boundary layer plus radiative transport resistance.



$$R_{\text{thermal},A,B} = R_{\text{thermal},A} + R_{\text{ambient},\text{indoor}} + R_{\text{ambient},\text{outdoor}} \quad (\text{Formula 4.1.2.3})$$

A typical assumption for non-ventilated walls is, for 2 surfaces, using the figures of equation 4.1.2.6 below:

$$R_{\text{ambient},\text{indoor}} + R_{\text{ambient},\text{outdoor}} = 0.25 \text{ K}/(\text{W}/\text{m}^2) \quad (\text{Formula 4.1.2.4})$$

The convective transport of heat from the wall to the ambient air,  $\Phi$ , is a function of the convection heat transfer coefficient,  $h_c$ , and the temperature difference between ambient air and sensor.

$$\Phi = h_c \cdot (T_{\text{ambient}} - T_{\text{object}}) = 1/R_{\text{ambient}} \quad (\text{Formula 4.1.2.5})$$

In buildings under indoor conditions we expect wind speeds of  $< 1$  m/s. Working environments will typically have wind speeds  $< 0.5$  m/s. Outdoors, wind speeds may reach 15 m/s under normal conditions, and up to 60 m/s in case of heavy storm.

An approximation of the heat transfer coefficient at a single surface at moderate ambient air speeds,  $V$ , and taking  $5 \text{ W}/(\text{m}^2 \cdot \text{K})$  for the radiative transfer coefficient, is given by:

$$h = h_r + h_c = 5 + 4 \cdot V \quad (\text{Formula 4.1.2.6})$$

According to ISO 9869, A.3.1, a common value for the heat transfer coefficient by convection,  $h_c$ , for a single surface is  $3.0 \text{ W}/(\text{m}^2 \cdot \text{K})$ ; in the equation above this would represent a wind speed of 0.75 m/s. The total heat transfer coefficient  $h$  for one surface then is  $8 \text{ W}/(\text{m}^2 \cdot \text{K})$ . For two surfaces it the  $R_{\text{ambient},\text{indoor}} + R_{\text{ambient},\text{outdoor}}$  then becomes 0.25 of equation 4.1.2.4. The radiative heat transfer coefficient of  $5 \text{ W}/(\text{m}^2 \cdot \text{K})$  follows from the Stefan–Boltzmann law, linearised around  $20 \text{ }^\circ\text{C}$ .

Measuring the thermal resistance of a building element, the duration of the test according to ISO 9869 should at least be 96 h (ISO 9869 paragraph 7.2.3). The user should verify the representativeness of the area with a thermal camera. The installation should not be in the vicinity of potential sources of error such as thermal bridges, cracks, heating or cooling devices and fans. Sensors should not be exposed to rain, snow, and direct solar radiation.

Installation is described in ISO 9869 paragraph 6.1.2. The standard recommends use of thermal paste and a passive guard ring with a width to thickness ratio of  $>5$ . Hukseflux discourages the use of thermal paste because it tends to dry out. Silicone glue and double sided tape are more reliable. HFP01 is equipped with a guard ring.

In some cases only night time data may be included in the analysis. At the end of a test the obtained R-value should not deviate by more than  $\pm 5 \%$  from the value obtained 24 h before. Chapters 7 and 8 of the ISO standard describe corrections for storage effects (changes in average wall temperature), added thermal resistance by the heat flux sensor, which we call the resistance error, and errors caused by the finite dimensions of the sensor. We use the term deflection error, while ISO uses the term operational error. ISO 9869 chapter 9 shows examples of uncertainty evaluation, arriving at typical

uncertainties of the order of  $\pm 20\%$  of on-site measurements of thermal resistances (between 14 and 28 %).

Sensors for measurement of temperature difference should be calibrated to an accuracy of  $\pm 0.1\text{ }^{\circ}\text{C}$ , reference paragraph 5.2.

Annex D.3.2 states that "the width of the guard ring should be at least 5 times the thickness of the heat flux meter".

ASTM C 1155 and ASTM 1046 focus on the measurement of thermal resistance  $R$  (from surface to surface) only. This is the  $R_{\text{thermal,A}}$  of equation 4.1.2.1.

ASTM 1155 defines a Heat Flow Sensor or Heat Flux Transducer (HFT). Paragraph 5.8 specifies that during the test the indoor temperature changes less than  $3\text{ }^{\circ}\text{C}$ , and specifies that the density of the construction material is  $< 440\text{ kg/m}^3$ . Areas with a high lateral heat flux should be avoided. Time constants should be estimated according to ASTM 1046. The duration of the test is at least 24 h, and a convergence test may be used to determine total required timespan.

ASTM 1046 offers good practices for installation and site selection.

#### 4.1.3 Measurements on glass windows

HFP01 may be mounted on glass windows; please note the following:

- we recommend using night-time data only. During daytime, the window material typically transmits solar radiation, while the HFP01 absorbs this radiation. During daytime the measurement is not representative of the heat flux through the window
- the user may correct for the resistance error

## 4.2 Heat flux measurement in meteorology

Many HFP01 sensors are used to measure heat flux in soils, as part of meteorological surface flux measurement systems. Typically the total measuring system consists of multiple heat flux- and temperature sensors, combined with measurements of air temperature, humidity, solar- or net radiation and wind speed.

In meteorological applications a heat flux sensor measures the energy that flows through the soil, typically at around 0.05 m depth. Usually this measurement is combined with measurements of the soil temperature to be able to estimate the heat flux at the soil surface. Knowing the heat flux at the soil surface, it is possible to "close the energy balance" and estimate the uncertainty of the measurement of the other (convective and evaporative) fluxes.

In most meteorological experiments, the main source of energy during daytime is downward solar radiation. The maximum power of the sun is about  $1500 \text{ W/m}^2$ , around noon at low latitudes under clear sky conditions. The solar radiation is either reflected or absorbed by the soil. The absorbed heat is divided between evaporation of water, heating of the ambient air and heating of the soil. At night, the sun is no longer present, the net irradiance is upward. The soil then loses energy through far infra-red radiation to the sky. The maximum upward net irradiance is about  $150 \text{ W/m}^2$ , under clear sky conditions. The heat flux in the soil at 0.05 m depth is usually between  $-100$  and  $+300 \text{ W/m}^2$ .

Measuring soil heat flux with HFP01, the main sources of uncertainty are:

1. representativeness: measurement at one location has an uncertain validity for the larger area under observation
2. deflection errors that cannot be corrected because soil thermal properties are unknown and variable over time and the contact to the soil may be unreliable
3. temperature dependence
4. non-stability

When estimating the surface heat flux at the soil surface, as opposed to the flux at 0.05 m depth, there is a fifth source of uncertainty:

5. uncertainty of the storage term (not formally part of the HFP01 measurement)

In case a more accurate measurement is required: see model [HFP01SC](#) self calibrating heat flux plate / sensor.

Ad 1: In field experiments it is difficult to find a single location that is representative of the whole region. On a limited timescale effects of shading of the soil surface can give an unrepresentative measurement. To be less sensitive to such effects, we recommend using two sensors for each station or measurement location, usually at a distance of  $> 5$  m.

Ad 2: A second significant source of measurement uncertainty in soil heat flux measurement is the deflection error. This error may be modelled as a change of the sensitivity of the heat flux sensor as a function of the thermal conductivity of the surrounding environment. This deflection error is described in detail in chapter 6. The properties of the surrounding environment, soil, are unknown and also change with time as a function of the soil moisture content.

A typical HFP01 has a thermal conductivity of  $0.8 \text{ W}/(\text{m}\cdot\text{K})$ , while thermal conductivity of soils can vary between  $0.2$  and  $2.5 \text{ W}/(\text{m}\cdot\text{K})$ . Sand in relatively dry condition has a thermal conductivity in the order of  $0.2 \text{ W}/(\text{m}\cdot\text{K})$ , saturated with water it may reach  $2.5 \text{ W}/(\text{m}\cdot\text{K})$ . A heat flux sensor model HFP01 performing a correct measurement in dry sand will make a significant error ( $> 10 \%$ ) in saturated sand. The calibration reference condition actually is  $0 \text{ W}/(\text{m}\cdot\text{K})$ , so in absolute terms the heat flux will always be underestimated.

Ad 3: The third important source of uncertainty is temperature dependence. Over the entire temperature range from  $-30$  to  $+70 \text{ }^\circ\text{C}$ , the uncertainty is  $\pm 5 \%$ .

Ad 4: Soil heat flux sensors are preferably left as long as possible in the soil, so that the soil properties and the soil surface become representative of the typical conditions of the area under observation. The sensor sensitivity however potentially changes with time. Under normal conditions this change is  $< 1 \%$ /yr. The user must excavate HFP01 sensors to verify their stable performance by laboratory calibration.



**Figure 4.2.1** typical meteorological surface energy balance measurement system with HFP01 installed under the soil.

Ad 5: For various reasons, practical as well as scientific, the heat flux plate must be installed under the soil, and not directly at the soil surface. First, mounting at the surface would distort the flow of moisture, and the measured flux would no longer be representative for the flux in the surrounding soil. Second, the absorption of solar radiation would not be representative. Third, the sensor would be more vulnerable. The mechanical stability of the installation then becomes an uncertain factor. Heat flux sensors in meteorological applications are typically buried at a depth of about 0.05 m below the soil surface. Installation at a depth of less than 0.05 m is not recommended. In most cases a 0.05 m soil layer on top of the sensor offers just sufficient mechanical stability to guarantee stable measurement conditions. Installation at a depth of more than 0.08 m is not recommended, because at larger depths of installation the time delay and amplitude of the measured heat flux becomes less accurately traceable to momentous flux at the soil surface.

For the above reasons the flux at the soil surface  $\Phi_{\text{surface}}$  is usually estimated from the flux measured by the heat flux sensor plus the change of the energy stored in the layer above the sensor during the measuring interval  $t_1$  to  $t_2$ .

$$\Phi_{\text{surface}} = \Phi_{0.05 \text{ m}} + S \quad (\text{Formula 4.2.1})$$

The quantity  $S$  is called the storage term.

The storage term is calculated from a space-averaged soil temperature measurement, using multiple soil temperature sensors, and an estimate of the volumic heat capacity  $C_{\text{volumic}}$  of the soil above the sensor.

$$S = (T(t_1) - T(t_2)) \cdot C_{\text{volumic}} \cdot X / (t_1 - t_2) \quad (\text{Formula 4.2.2})$$

Where  $T(t_1) - T(t_2)$  is the temperature difference in the measurement interval,  $x$  the depth of installation of the soil heat flux sensors.

A correct estimate of  $\Phi_{\text{surface}}$  with a high time resolution requires a low installation depth and a correct estimate of the storage term.

At an installation depth of 0.05 m, the storage term typically represents up to 50 % of the total  $\Phi_{\text{surface}}$ . When the temperature  $T$  is measured closely below the surface, the response time of the storage term to a changing  $\Phi_{\text{surface}}$  is in the order of magnitude of 20 min, while the heat flux sensor buried at twice the depth is a factor 5 slower (square of the depth). The volumic heat capacity is estimated from the specific heat capacity of dry soil,  $C_{\text{soil, dry}}$ , the bulk density of the dry soil  $\rho$ , the water content (on mass basis),  $Q$ , and  $C_{\text{water}}$ , the volumic heat capacity of water.

$$C_{\text{volumic}} = \rho_{\text{soil, dry}} \cdot C_{\text{soil, dry}} + Q \cdot C_{\text{volumic, water}} \quad (\text{Formula 4.2.3})$$

The heat capacity of water is known, but the other quantities of the equation are difficult to determine and vary with location and time. The storage term may be the main source of uncertainty in the soil energy balance measurement.

A typical value for dry soil heat capacity is 840 J/(kg·K).

## 5 Installation of HFP01

### 5.1 Site selection and installation in building physics

**Table 5.1.1** *Recommendations for installation of heat flux sensors in building physics (continued on the next page)*

Location	<p>preferably mount heat flux sensors indoors and not outdoors preferably use a large wall section which is relatively homogeneous in the northern hemisphere, north-facing walls are preferred</p> <p>do not expose to sun, rain, etc. do not expose to drafts and lateral heat fluxes do not mount in the vicinity of thermal bridges, cracks, heating or cooling devices and fans</p> <p>close window blinds and curtains switch off artificial light sources</p> <p>for detailed analysis of a single building element users may consider to install one heat flux sensor indoors, and the other outdoors. measuring on two sides permits a detailed analysis of the thermal response time.</p> <p>for mounting sensors on glass windows: see paragraph 4.1.3.</p>
Orientation	<p>the two sensor sides are equivalent.</p> <p>recommended orientation is with the red face of the sensor facing indoors, and the blue face connected to the indoor wall. This generates a positive output signal when the heat flux direction is from indoors to outdoors.</p> <p>reversing the sensor orientation will result in a change of sign of the voltage output. If necessary, this may be compensated by reversing the wiring at the datalogger connection, or in the post processing for example by giving the sensitivity a negative sign.</p>
Performing a representative measurement	<p>we recommend using &gt; 2 sensors per measurement location (wall). This redundancy also improves the assessment of the measurement accuracy</p>
Creating a temperature difference	<p>for the measurement of thermal resistance of walls it is best to have a constant high level heat flux; strongly cooled or strongly heated rooms are ideal. We recommend activating heaters or air conditioning to create optimal conditions.</p>

**Table 5.1.1** Recommendations for installation of heat flux sensors in building physics (started on the previous page)

Mechanical mounting	<p>avoid any air gaps between sensor and wall. Air thermal conductivity is in the 0.02 W/(m·K) range, while a common glue has a thermal conductivity around 0.2 W/(m·K). A <math>0.1 \times 10^{-3}</math> m air gap increases the effective thermal resistance of the sensor by 60 %.</p> <p>we recommend use of double-sided “removable” carpet laying tape such as TESA 4939, which has free removability up to 14 days from the most common surfaces (needs to be tested individually before usage).</p> <p>for thermocouple mounting the same tape may be used as for the heat flux sensors.</p> <p>for long-term installation and for filling up large gaps, use silicone construction sealant, glue or adhesive, that can be bought in construction depots. During curing of the silicone, typically 24 h, the sensor must be temporarily held in place by other means.</p> <p>we discourage the use of thermal paste because it tends to dry out. silicone glue and double sided tape are more stable and reliable.</p> <p>usually the cables are provided with an additional strain relief, for example using a cable tie mount as in figure 5.1.1.</p>
Added temperature sensors	<p>for <math>\Lambda</math>-value: temperature sensors should measure wall surface temperature. They are typically located close to the sensor attached to both sides of the wall.</p> <p>for R-value: temperature sensors should measure ambient air temperature. They are typically located close to the sensor at both sides of the wall, however not attached to the wall. Ambient air temperature sensors should be shielded from solar radiation.</p>
Avoiding spectral errors	<p>in case of exposure solar radiation or to artificial light sources, the spectral properties of the sensor surface must match those of the wall. This is attained by covering the sensor with paint or sheet material of the same colour as the wall.</p>
Signal amplification	<p>see the paragraph on electrical connection. In case of low heat fluxes and signals that are too small, consider use of multiple sensors electrically in series or consider using model HFP03.</p>



**Figure 5.1.1** Installation of HFP01 on a wall using sided "removable" carpet laying tape such as TESA 4939, and a strain relief of the cable using a cable tie mount equipped with the same carpet laying tape as adhesive.



## 5.2 Site selection and installation in meteorology / the soil

**Table 5.2.1** Recommendations for installation of heat flux sensors in building physics

Location	preferably install in a large field which is relatively homogeneous and representative of the area under observation.
Orientation	<p>the two sensor sides are equivalent. Recommended orientation is with the red side of the sensor facing up. This generates a positive output signal when the net heat flux is downward.</p> <p>reversing the sensor orientation will result in a change of sign of the voltage output. If necessary, this may be compensated by reversing the wiring at the datalogger connection, or in the post processing for example by giving the sensitivity a negative sign.</p>
Performing a representative measurement	we recommend using > 2 sensors per location at a distance of > 5 m. This redundancy also improves the assessment of the measurement accuracy.
Installation in the soil	<p>depth of installation typically is 0.05 m.</p> <p>if possible, install the sensor from the side of a small hole. There should be no air gaps between sensor and soil. A <math>0.1 \times 10^{-3}</math> m air gap increases the effective thermal resistance of the sensor by 60 %.</p> <p>Use a shovel to make a vertical slice in the soil. Make a hole in the soil at one side of the slice. Keep the excavated soil intact so that after installing the sensor the original soil structure can be restored. The sensor is installed in the undisturbed face of the excavated hole. Measure the depth from the soil surface at the top of the hole. With a knife, make a horizontal cut at the required depth of installation, for example at 0.05 m below the surface, into the undisturbed face of the hole. Insert the heat flux sensor into the horizontal cut.</p> <p>Never run the sensor cable directly to the surface. Bury the sensor cable horizontally over a distance of at least 1 m, to minimise thermal conduction through the lead wire. Put the excavated soil back into its original position after the sensor and cable are installed.</p>
Fixation / strain relief	for mechanical stability provide sensor cables with an additional strain relief, for example connecting the cable with a tie wrap to a metal pin that is inserted firmly into the soil.
Armoured cable	in some cases cables are equipped with additional armour to avoid damage by rodents. Make sure the armour does not act as a conductor of heat or a transport conduit or container of water.
Added temperature sensors	temperature sensors are typically located close to the heat flux sensor at 2 depths above it: when the sensor is buried at 0.05 m, temperature sensors may be buried at 0.02 and 0.04 m below the soil surface.
Improving measurement accuracy	when measuring in soils, we recommend using model HFP01SC to get a higher level of quality assurance and accuracy of the measurement. The HFP01SC self-calibration compensates for the temperature dependence, the non-stability and the deflection error.
Signal amplification	see the paragraph on electrical connection. In case of low heat fluxes and signals that are too small to measure, consider use of multiple sensors in series and consider using model HFP03.

## 5.3 Electrical connection

### 5.3.1 Normal connection

A heat flux sensor should be connected to a measurement system, typically a so-called datalogger. HFP01 is a passive sensor that does not need any power. Cables may act as a source of distortion, by picking up capacitive noise. We recommend keeping the distance between a datalogger or amplifier and the sensor as short as possible. For cable extension, see the appendix on this subject.

**Table 5.3.1.1** *The electrical connection of HFP01. The cable internally also has a brown wire, which is not used and which is not visible when supplied from the factory. The wires extend 0.15 m from the cable end.*

WIRE	MEASUREMENT SYSTEM	
White	signal [+]	voltage input [+]
Green	signal [-]	voltage input [-] or ground
Black	ground	analogue ground

The sensor serial number and sensitivity are shown on the HFP01 product certificate and on 2 cable labels (one at sensor end, one at cable end).

### 5.3.2 Increasing sensitivity, connecting multiple sensors in series

Multiple sensors may be electrically connected in series. The resulting sensitivity is the sum of the sensitivity of the individual sensors. Below the equations in case two sensors are used. If needed, more than 2 sensors may be put in series, again increasing the sensitivity.

$$E = U / (S_1 + S_2) \quad \text{(Formula 5.3.2.1)}$$

and

$$U = U_1 + U_2 \quad \text{(Formula 5.3.2.2)}$$

**Table 5.3.2.1** *The electrical connection of two HFP01's, 1 and 2, in series. In such case the sensitivity is the sum of the two sensitivities of the individual sensors. More sensors may be added in a similar manner.*

SENSOR	WIRE		MEASUREMENT SYSTEM
1	White	signal 1 [+]	voltage input [+]
1	Green	signal 1 [-]	connected to signal 2 [+]
1	Black	ground	analogue ground
2	White	signal 2 [+]	connected to signal 1 [-]
2	Green	signal 2 [-]	voltage input [-] or ground
2	Black	ground	analogue ground

The serial number and sensitivity of the individual sensor are shown on the HFP01 product certificate and on 2 cable labels (one at sensor end, one at cable end).

## 5.4 Requirements for data acquisition / amplification

The selection and programming of dataloggers is the responsibility of the user. Please contact the supplier of the data acquisition and amplification equipment to see if directions for use with the HFP01 are available. In case a program for similar instruments is available, this can be used. HFP01 can be treated in the same way as other heat flux sensors and thermopile pyranometers.

**Table 5.4.1** *Requirements for data acquisition and amplification equipment for HFP01 in the standard configuration*

Capability to measure small voltage signals	preferably: $< 5 \times 10^{-6}$ V uncertainty minimum requirement: $20 \times 10^{-6}$ V uncertainty (valid for the entire expected temperature range of the acquisition / amplification equipment)
Capability for the data logger or the software	to store data, and to perform division by the sensitivity to calculate the heat flux. $E = U/S$ (Formula 0.1)
Data acquisition input resistance	$> 1 \times 10^6 \Omega$
Open circuit detection (WARNING)	open-circuit detection should not be used, unless this is done separately from the normal measurement by more than 5 times the sensor response time and with a small current only. Thermopile sensors are sensitive to the current that is used during open circuit detection. The current will generate heat, which is measured and will appear as a temporary offset.

## 6 Making a dependable measurement

### 6.1 Uncertainty evaluation

A measurement with a heat flux sensor is called “dependable” if it is reliable, i.e. measuring within required uncertainty limits, for most of the time and if problems, once they occur, can be solved quickly.

In case of heat flux sensors, the measurement uncertainty is a function of:

- calibration uncertainty
- differences between reference conditions during calibration and measurement conditions, for example uncertainty caused temperature dependence of the sensitivity
- the duration of sensor employment (involving the non-stability)
- application errors: the measurement conditions and environment in relation to the sensor properties, the influence of the sensor on the measurand, the representativeness of the measurement location

It is not possible to give one figure for heat flux sensor measurement uncertainty. Statements about the overall measurement uncertainty can only be made on an individual basis, taking all these factors into account.

Guidelines for uncertainty evaluation:

- 1) The formal evaluation of uncertainty should be performed in accordance with ISO 98-3 Guide to the Expression of Uncertainty in Measurement, GUM.
- 2) Uncertainties are entered in measurement equation (equation is usually Formula 0.1:  $E = U/S$ ), either as an uncertainty in  $E$  (non-representativeness, resistance error and deflection error) in  $U$  (voltage readout errors) or in  $S$  (non-stability, temperature dependence, calibration uncertainty).
- 3) In case of special measurement conditions, typical specification values are chosen. These should for instance account for environmental conditions (working temperature range).
- 4) Among the various sources of uncertainty, some are “correlated”; i.e. present during the entire measurement process, and not cancelling or converging to zero when averaged over time; the off-diagonal elements of the covariance matrix are not zero. Paragraph 5.2 of GUM.
- 5) Among the various sources of uncertainty, some are “uncorrelated”; cancelling or converging to zero when averaged over time; the off-diagonal elements of the covariance matrix are zero. Paragraph 5.1 of GUM.

## 6.2 Typical measurement uncertainty budget

**Table 6.2.1** typical measurement uncertainties ( $k = 2$ ) when measuring heat flux with HFP01 heat flux sensors.

APPLICATION	TYPICAL MEASUREMENT UNCERTAINTY BUDGET ( $k = 2$ )
Building physics	<p>Under ideal conditions, measurements of heat flux in building physics may attain uncertainties in the <math>\pm 6\%</math> range.</p> <p>Contributions to the uncertainty budget: calibration, temperature dependence from <math>-10</math> to <math>+30\text{ }^{\circ}\text{C}</math>, thermal conductivity of the surrounding environment from <math>0.5</math> to <math>1.5\text{ W}/(\text{m}\cdot\text{K})</math>, representativeness of the measurement location.</p> <p>ISO 9869 chapter 9 shows examples of uncertainty evaluation, for thermal resistance measurement. This uncertainty budget also includes contributions from the temperature measurements and dynamic effects. It arrives at typical uncertainties of the order of <math>\pm 20\%</math> of on-site measurements of thermal resistances.</p> <p>Corrections may be applied according to chapter 8 of ISO 9869. These corrections include corrections for the thermal resistance and corrections for the finite dimension of the sensor. ISO also calls the latter the operational error, we use the term deflection error.</p>
Meteorology	<p>Measurements of heat flux in the soil may attain uncertainties in the <math>\pm 20\%</math> range</p> <p>Contributions to the uncertainty budget: calibration, temperature dependence from <math>-20</math> to <math>+50\text{ }^{\circ}\text{C}</math>, thermal conductivity of the surrounding soil from <math>0.15</math> to <math>2.5\text{ W}/(\text{m}\cdot\text{K})</math>, representativeness of the measurement location.</p> <p>Not included: estimates of the storage term, which are not part of the HFP01 measurement.</p>

## 6.3 Contributions to the uncertainty budget

### 6.3.1 Calibration uncertainty

HFP01's factory calibration uncertainty under reference conditions is  $\pm 3\%$  with a coverage factor  $k = 2$ .

### 6.3.2 Uncertainty caused by non-stability

HFP01's non-stability specification is  $< 1\%$ /yr.

This means that for every year of operation,  $1\%$  uncertainty should be added in the uncertainty budget.

### 6.3.3 Uncertainty caused by - and correction of the resistance error

When mounting the sensor in a certain environment or on an object, its thermal resistance may significantly change the total thermal resistance of the object under observation (usually a wall). The resulting measurement error is called resistance error.

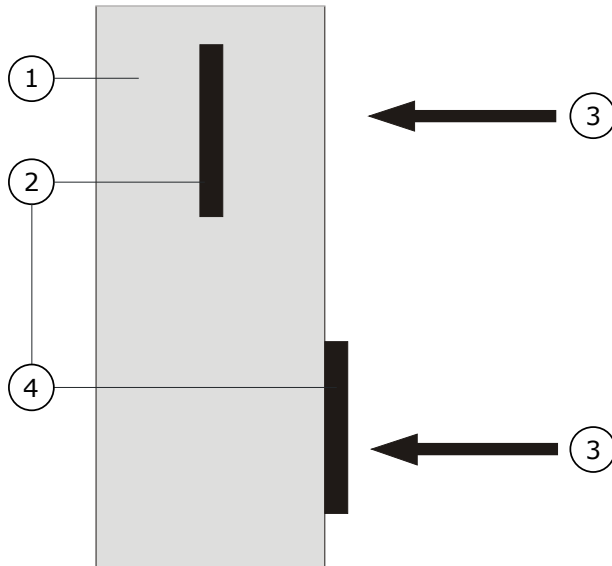

**Figure 6.3.3.1** *The resistance error: a heat flux sensor (2) increases or decreases the total thermal resistance of the object on which it is mounted (1) or in which it is incorporated. This can either lead to an increase of or decrease of the measured heat flux (3).*

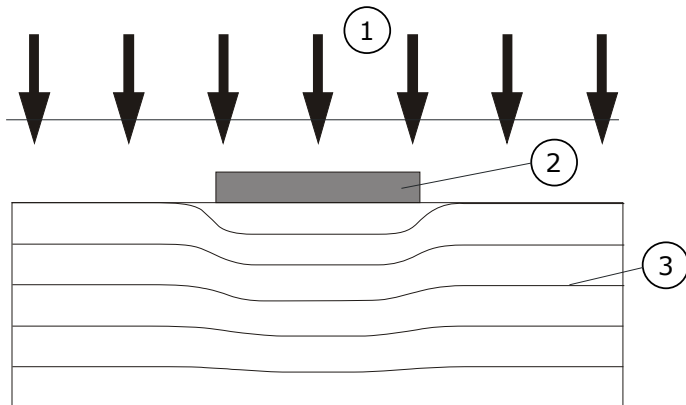

**Figure 6.3.3.2** *The resistance error: a heat flux sensor (2) increases or decreases the total thermal resistance of the object on which it is mounted or in which it is incorporated. An otherwise uniform flux (1) is locally disturbed. Lines (3) represent isotherms. In this case the measured heat flux is smaller than the actual undisturbed flux, (1).*

Taking a sensor mounted on a wall as an example, a first order correction of the measurement is:

$$\Phi = ((R_{\text{wall}} + R_{\text{sensor}})/R_{\text{wall}}) \cdot (U/S) \quad (\text{Formula 6.3.3.1})$$

This correction  $(R_{\text{wall}} + R_{\text{sensor}})/R_{\text{wall}}$  is often applied to measurements on thin or badly insulated walls and measurements on windows. This correction can only be determined for objects with limited (finite) dimensions. For this reason this correction is not applicable in soils.

Also contact resistances between sensor and the surrounding environment may contribute to the resistance error. Air gaps add to the sensor thermal resistance. The contact between sensor and surrounding environment should be as small and as stable as possible. The thermal conductivity of air is approximately  $0.02 \text{ W}/(\text{m}\cdot\text{K})$ , a factor 30 smaller than that of the heat flux sensor. A  $0.1 \times 10^{-3} \text{ m}$  air gap increases the effective thermal resistance of the sensor by 60 %. Air gaps form major contact resistances. Avoiding the presence of air gaps should be a priority whenever heat flux sensors are installed.

#### 6.3.4 Uncertainty caused by - and correction of the deflection error

The thermal conductivity of the surrounding environment may differ from the sensor thermal conductivity. The heat flux will then deflect. The resulting measurement error is called the deflection error. The deflection error may be estimated by experiments or by numerical simulation.

Corrections may be applied according to chapter 8 of ISO 9869. These corrections include corrections for the finite dimension of the sensor. ISO also calls this the operational error, we use the term deflection error.

As figure 6.3.4.1 illustrates, the deflection error is largest at the sensor edges, and smaller at the centre. For this reason sensors are equipped with a passive guard around the sensitive sensor area.

For sensors that are fully surrounded by a uniform homogeneous material which have a perfect thermal connection, the deflection error may be expressed as thermal conductivity dependence  $D_{\lambda}$  of the sensitivity  $S$ . The order of magnitude of  $D_{\lambda}$  is constant for one sensor model. The order of magnitude of  $D_{\lambda}$  is  $7 \text{ \%}/(\text{W}/(\text{m}\cdot\text{K}))$ . The value of  $\lambda_{\text{reference}}$  is  $0.0 \text{ W}/(\text{m}\cdot\text{K})$ .

$$S = S_{\text{reference}} \cdot (1 + D_{\lambda} \cdot (\lambda_{\text{environment}} - \lambda_{\text{reference}})) \quad (\text{Formula 6.3.4.1})$$

A correction may be applied when there is a substantial amount (at least  $40 \times 10^{-3} \text{ m}$ ) of the same material at both sides of the sensor. In soils  $\lambda_{\text{environment}}$  usually is not known.

We discourage correction for this error because it relies on the assumption that the properties of the surrounding material as well as the contact resistance are known.



When measuring in soils, we recommend using model HFP01SC to get a higher level of quality assurance and accuracy of the measurement. The HFP01SC self-calibration compensates for the temperature dependence, the non-stability and the deflection error.

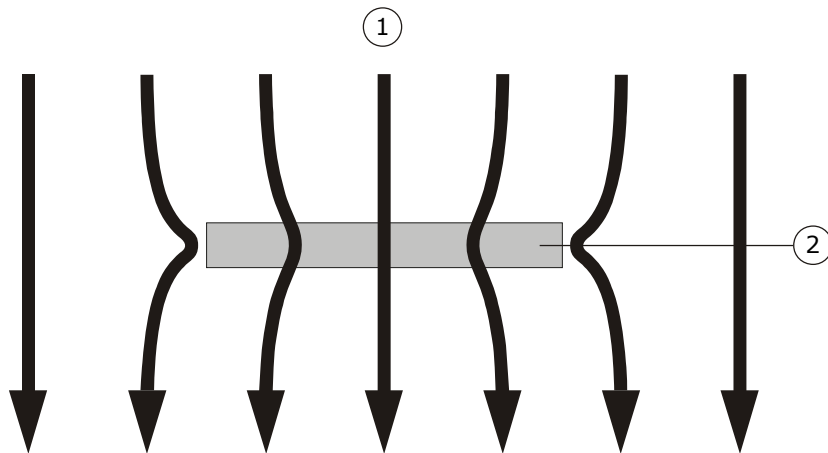

**Figure 6.3.4.1** *The deflection error. The heat flux (1) is deflected in particular at the edges of the sensor. The measurement will contain an error; the so-called deflection error. The magnitude of this error depends on the thermal conductivity of the environment, sensor thermal conductivity as well as sensor design and contact resistance.*

### 6.3.5 Uncertainty caused by temperature dependence

HFP01's temperature dependence specification is  $< 0.1 \text{ \%}/^{\circ}\text{C}$ .

This means that for every  $^{\circ}\text{C}$  deviation from the  $20 \text{ }^{\circ}\text{C}$  reference temperature,  $0.1 \text{ \%}$  uncertainty should be added in the uncertainty budget.

When measuring in soils, we recommend using model HFP01SC to get a higher level of quality assurance and accuracy of the measurement. The HFP01SC self-calibration compensates for the temperature dependence.

## 7 Maintenance and trouble shooting

### 7.1 Recommended maintenance and quality assurance

HFP01 measures reliably at a low level of maintenance. Unreliable measurement results are detected by scientific judgement, for example by looking for unreasonably large or small measured values. The preferred way to obtain a reliable measurement is a regular critical review of the measured data, preferably checking against other measurements.

**Table 7.1.1** *Recommended maintenance of HFP01. If possible the data analysis is done on a daily basis.*

<b>MINIMUM RECOMMENDED HEAT FLUX SENSOR MAINTENANCE</b>			
	INTERVAL	SUBJECT	ACTION
1	1 week	data analysis	compare measured data to the maximum possible or maximum expected heat flux and to other measurements for example from nearby stations or redundant instruments. Historical seasonal records can be used as a source for expected values. Look for any patterns and events that deviate from what is normal or expected. Compare to acceptance intervals. Plot heat flux data against other meteorological measurands, in particular net radiation and soil temperature.
2	6 months	inspection	inspect cable quality, inspect mounting, inspect location of installation look for seasonal patterns in measurement data
3	2 years	recalibration	recalibration by comparison to a calibration standard instrument in the field, see following paragraphs.  recalibration by the sensor manufacturer
4		lifetime assessment	judge if the instrument will be reliable for another 2 years, or if it should be replaced

## 7.2 Trouble shooting

**Table 7.2.1** *Trouble shooting for HFP01*

General	<p>Inspect the sensor for any damage. Inspect the quality of mounting / installation. Inspect if the wires are properly attached to the data logger. Check the condition of the cable. Inspect the connection of the shield (typically connected at the datalogger side). Check the datalogger program in particular if the right sensitivity is entered. HFP01 sensitivity and serial number are marked on its cable. Check the electrical resistance of the sensor between the green [-] and white [+] wires. Use a multimeter at the 100 <math>\Omega</math> range. Measure the sensor resistance first with one polarity, then reverse the polarity. Take the average value. The typical resistance of the wiring is 0.1 <math>\Omega</math>/m. Typical resistance should be the nominal sensor resistance of 1 to 4 <math>\Omega</math> plus 1.5 <math>\Omega</math> for the total resistance of two wires (back and forth) of each 5 m. Infinite resistance indicates a broken circuit; zero or a low resistance indicates a short circuit.</p>
The sensor does not give any signal	<p>Check if the sensor reacts to heat: put the multimeter at its most sensitive range of DC voltage measurement, typically the 100 x 10<sup>-3</sup> VDC range or lower. Expose the sensor heat, for instance touching it with your hand. The signal should read &gt; 2 x 10<sup>-3</sup> V now. Touching or exposing the red side should generate a positive signal, doing the same at the opposite side the sign of the output voltage reverses. Check the data acquisition by replacing the sensor with a spare unit.</p>
The sensor signal is unrealistically high or low	<p>Check the cable condition looking for cable breaks. Check the data acquisition by applying a 1 x 10<sup>-6</sup> V source to it in the 1 x 10<sup>-6</sup> V range. Look at the measurement result. Check if it is as expected. Check the data acquisition by short circuiting the data acquisition input with a 10 <math>\Omega</math> resistor. Look at the output. Check if the output is close to 0 W/m<sup>2</sup>.</p>
The sensor signal shows unexpected variations	<p>Check the presence of strong sources of electromagnetic radiation (radar, radio). Check the condition and connection of the shield. Check the condition of the sensor cable. Check if the cable is not moving during the measurement.</p>

### 7.3 Calibration and checks in the field

The recommended calibration interval of heat flux sensors is 2 years.  
Recalibration of field heat flux sensors is ideally done by the sensor manufacturer.

On-site field calibration is possible by comparison to a calibration reference sensor.  
Usually mounted side by side, alternatively mounted on top of the field sensor.

Hukseflux main recommendations for field calibrations are:

- 1) to compare to a calibration reference of the same brand and type as the field sensor
- 2) to connect both to the same electronics, so that electronics errors (also offsets) are eliminated.
- 3) to mount all sensors on the same platform, so that they have the same body temperature.
- 4) typical duration of test: > 24 h
- 5) typical heat fluxes used for comparison: > 20 W/m<sup>2</sup>
- 6) to correct deviations of more than  $\pm 10\%$ . Lower deviations should be interpreted as acceptable and should not lead to a revised sensitivity.

## 8 HFP03

### 8.1 Introduction HFP03

Sensor model HFP03 is a high-sensitivity version of HFP01. The plate's diameter is larger.

HFP03 is specifically suitable for measurement of small flux levels, in the order of less than  $1 \text{ W/m}^2$ , for instance in geothermal applications. By using a ceramics-plastic composite body the total thermal resistance is kept small. See also model HFP01: putting several HFP01 sensors electrically in series is an alternative for using HFP03.

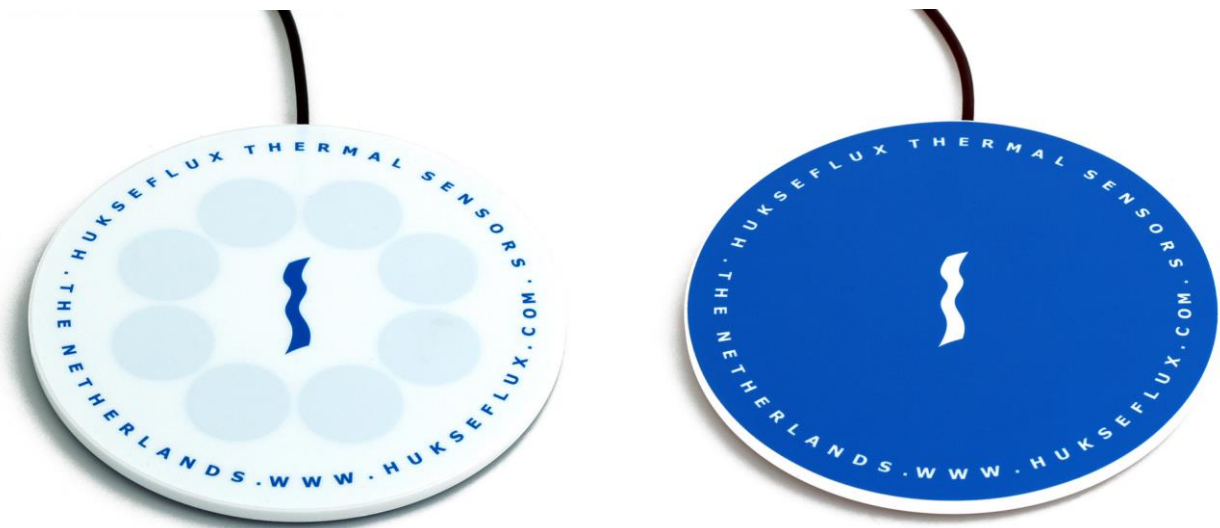

**Figure 8.1.1** HFP03 ultra sensitive heat flux sensor. The opposite side has a blue cover.

**Table 8.1.1** Specifications of HFP03, listing only those specifications which deviate from HFP01

<b>HFP03 SPECIFICATIONS</b>	
Sensor type	ultra sensitive heat flux plate / heat flux sensor
Sensitivity (nominal)	$500 \times 10^{-6} \text{ V}/(\text{W/m}^2)$
Directional sensitivity	heat flux from the white to the blue side generates a positive voltage output signal
Sensor resistance range	10 to $32 \Omega$ (nominal $18 \Omega$ )
Weight including 5 m cable	approx. 1 kg
Sensing area	$64 \times 10^{-4} \text{ m}^2$
Sensing area diameter	8 area's of $32 \times 10^{-3} \text{ m}$
Passive guard area	$168 \times 10^{-4} \text{ m}^2$ (a passive guard is required by ISO 9869)
Sensor diameter including guard	$172 \times 10^{-3} \text{ m}$
Uncertainty of calibration	$\pm 3 \%$ ( $k=2$ )
Gross weight including 5 m cable	approx. 0.5 kg
Net weight including 5 m cable	approx. 0.5 kg

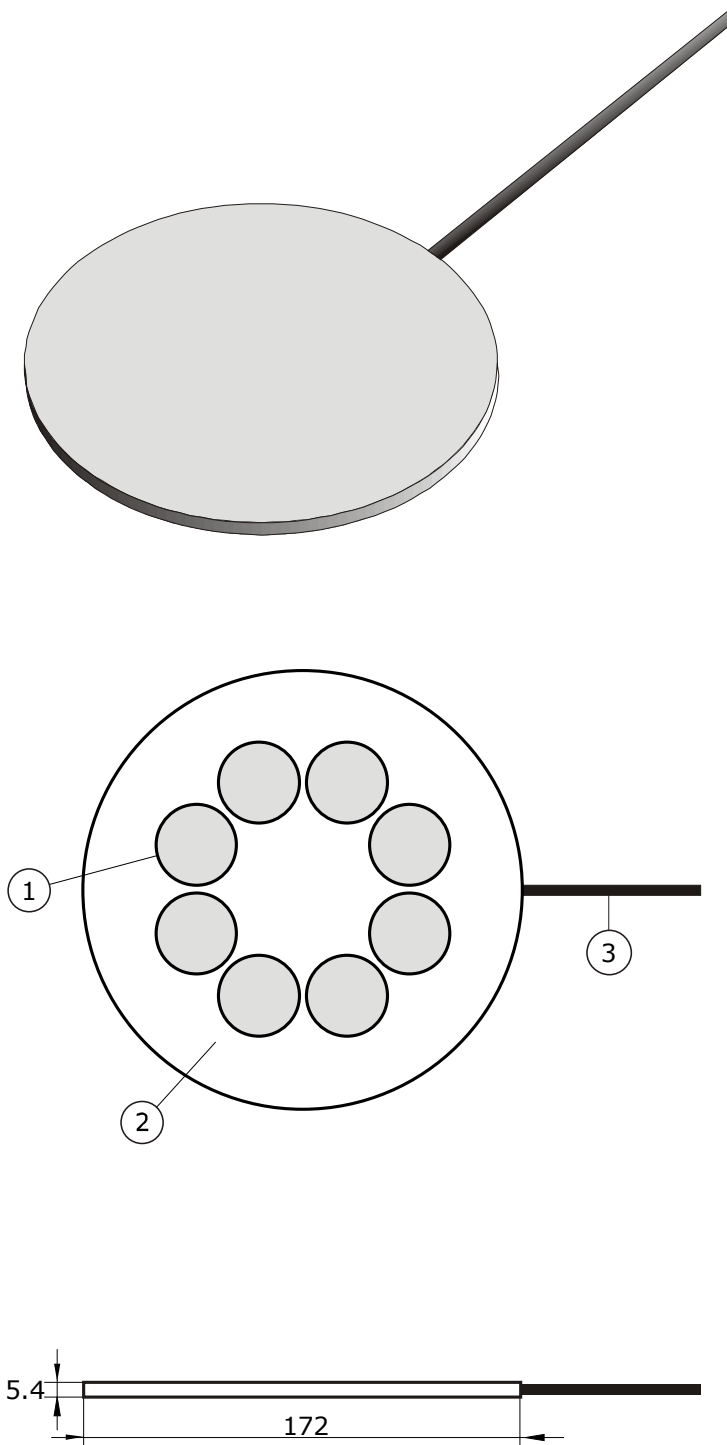

**Figure 8.1.2** HFP03 heat flux sensor dimensions in  $\times 10^{-3}$  m

- (1) 8 x sensing area
- (2) passive guard of ceramics-plastic composite
- (3) cable (standard length 5 m, optionally longer cable in multiples of 5 m, cable lengths above 20 m in multiples of 10 m.)

Total sensor thickness including covers is  $5.4 \times 10^{-3}$  m



## 9 Appendices

### 9.1 Appendix on cable extension / replacement

HFP01 is equipped with one cable. Keep the distance between data logger or amplifier and sensor as short as possible. Cables may act as a source of distortion by picking up capacitive noise. In an electrically “quiet” environment the HFP01 cable may be extended without problem to 100 metres. If done properly, the sensor signal, although small, will not significantly degrade because the sensor resistance is very low (which results in good immunity to external sources) and because there is no current flowing (so no resistive losses). Cable and connection specifications are summarised below.

**Table 9.1.1** Preferred specifications for cable extension of HFP01

Cable	2-wire, shielded, with copper conductor (at Hukseflux 3-wire shielded cable is used, of which only 2 wires are used)
Extension sealing	make sure any connections are sealed against humidity ingress
Conductor resistance	< 0.1 $\Omega$ /m
Outer diameter	4 x 10 <sup>-3</sup> m
Length	cables should be kept as short as possible, in any case the total cable length should be less than 100 m
Outer mantle	with specifications for outdoor use (for good stability in outdoor applications)
Connection	either solder the new cable conductors and shield to those of the original sensor cable, and make a waterproof connection using heat-shrink tubing with hot-melt adhesive, or use gold plated waterproof connectors. Always connect the shield.



## 9.2 Appendix on standards for calibration

The standard ASTM C1130 Standard Practice for Calibrating Thin Heat Flux Transducers specifies in chapter 6 that a guarded hot plate, a heat flowmeter, a hot box or a thin heater apparatus are all allowed. Hukseflux employs a thin heater apparatus, uses a linear function according to X1.1 and uses a nominal temperature of 20 °C, in accordance with X2.2.

The Hukseflux HFPC01 method relies on a thin heater apparatus according to principles as described in paragraph 4 of ASTM C1114-06, used in the single sided mode of operation described in paragraph 8.2 and in ASTM C1044.

ISO does not have a dedicated standard practice for heat flux sensor calibration. ISO 9869 paragraph 5.1 recommends calibration according to ISO 8302 (guarded hot plate) or ISO 8301 (heat flow meter apparatus) with a  $\pm 2\%$  accuracy. We assume that this statement is with a coverage factor  $k = 1$ .

For a known model, paragraph 5.1.2 allows one heat flow, a typical temperature during use and on a typical building material. ISO 9869 does not describe the calibration apparatus of method. We follow the recommended practice of ASTM C1130.

**Table 9.2.1** *heat flux sensor calibration according to ISO and ASTM.*

STANDARDS ON INSTRUMENT CLASSIFICATION AND CALIBRATION	
ISO STANDARD	EQUIVALENT ASTM STANDARD
no dedicated heat flux calibration standard available. ISO 9869 allows the user to choose his calibration method.	<p>ASTM C1130 Standard Practice for Calibrating Thin Heat Flux Transducers</p> <p>ASTM C 1114-06 Standard Test Method for Steady-State Thermal Transmission Properties by Means of the Thin-Heater Apparatus</p> <p>ASTM C1044 - 12 Standard Practice for Using a Guarded-Hot-Plate Apparatus or Thin-Heater Apparatus in the Single-Sided Mode</p>

## 9.3 Appendix on calibration hierarchy

HFP01 factory calibration is traceable from SI through international standards and through an internal mathematical procedure which corrects for known errors. The formal traceability of the generated heat flux is through voltage and current to electrical power and electric power and through length to surface area.

The Hukseflux HFPC01 method follows the recommended practice of ASTM C1130. It relies on a thin heater apparatus according to principles as described in paragraph 4 of ASTM C1114-06, in the single sided mode of operation described in paragraph 8.2 and in ASTM C1044. In accordance with ISO 9869, the method has been validated in a first-party conformity assessment, by comparison to calibrations in a guarded hot plate.

### 9.4 Appendix on using HFP01 with BLK – GLD sticker series

BLK-80 and GLD-80 stickers are accessories to HFP01 heat flux sensors. A sensor equipped with a BLK black sticker is sensitive to both radiative and convective heat flux. A sensor equipped a GLD gold sticker reflects radiation and measures convective heat flux only. To calculate the radiative heat flux, subtract the two measurements.

BLK - GLD stickers are designed to be applied by the user. Optionally, it is also possible to order HFP01 with stickers pre-applied at the factory.

For more details, see the BLK – GLD sticker series user manual.



**Figure 9.4.1** HFP01 heat flux sensor: with BLK-80 and GLD-80 stickers

**Table 9.4.1** Recommendations for use of HFP01 heat flux sensors with BLK – GLD sticker series

Mounting	<p>when mounting HFP01 with a BLK or GLD sticker, keep the directional sensitivity in mind.</p> <p>heat flux from the back side (coloured blue) to the front side (coloured red) generates a positive voltage output signal.</p>
Mounting on curved surfaces	apply BLK – GLD stickers before mounting the sensor
Location	avoid direct exposure to the sun
Effect on sensitivity	no significant influence on sensitivity

## 9.5 EU declaration of conformity



We, Hukseflux Thermal Sensors B.V.  
Delftechpark 31  
2628 XJ Delft  
The Netherlands

in accordance with the requirements of the following directive:

2014/30/EU The Electromagnetic Compatibility Directive

hereby declare under our sole responsibility that:

Product model: HFP01  
Product type: Heat flux sensor / heat flux plate

has been designed to comply and is in conformity with the relevant sections and applicable requirements of the following standards:

Emission: EN 61326-1 (2006)  
Immunity: EN 61326-1 (2006)  
Emission: EN 61000-3-2 (2006)  
Emission: EN 61000-3-3 (1995) + A1 (2001) + A2 (2005)  
Report: 08C01340RPT01, 06 January 2009



Eric HOEKSEMA  
Director  
Delft  
September 08, 2015



