



MULTIDETEK₂



USER'S MANUAL

GAS CHROMATOGRAPH FOR MULTIPLE IMPURITIES



MultiDetek 2

Trace impurities analyzer

USER'S MANUAL
V3.9

Printed in Canada
Copyright 2016

Table of Contents

	Page
1. Forewarning	1
2. Warranty, maintenance and service policies.....	2
3. Declaration of conformity.....	5
4. Specifications.....	8
5. Cautions and installation information.....	9
5.1 Detector cautions	9
5.2 Analyzer application	10
5.3 Start-up.....	10
5.4 Shut-off.....	16
5.5 Typical installation.....	17
5.5.1 Carrier gas	17
5.5.2 Valves actuation.....	20
5.5.3 O2 doping.....	23
6. Hardware description	25
6.1 Detectors	25
6.2 Motherboard.....	26
6.3 Sample gas proportional valve, mini pump or septum injector	27
6.4 Diaphragm valve and purged/heated valve box.....	27
6.5 Carrier gas electronic pressure regulator (LDepc).....	28
6.6 Ovens and columns	28
6.7 Large 8.4’’ touch screen LCD & LDChroma	29
6.8 Built-in sample purging and monitoring system.....	29
6.9 Bolt on compact purifier	31
6.10 Advanced Quartz Crystal Microbalance sensor.....	31
7. LDChroma	32
7.1 Configuration	32
7.1.1 Machine.....	32
7.1.2 Method	33
7.1.3 Factory	33
7.1.4 Network.....	33
7.1.5 User and Admin Mode.....	34
7.2 Chromatogram tab	35
7.2.1 Chromatogram	35
7.2.2 Bottom bar	36
7.2.2.1 Left bottom bar	36
7.2.2.2 Middle bottom bar.....	37
7.2.2.3 Right bottom bar	38
7.2.3 Historic.....	39
7.3 Settings Menu	41
7.3.1 Setting	41
7.3.1.1 Misc.....	42
7.3.1.2 Peak.....	43

7.3.1.3 Flow	45
7.3.1.4 Oven.....	47
7.3.1.5 Detector.....	49
7.3.1.6 Sensor.....	50
7.3.1.7 Valve.....	51
7.3.1.8 Misc.....	52
7.3.1.9 4-20mA	53
7.3.1.10 Stream	54
7.3.1.11 Sequence	55
7.3.1.12 Column.....	56
7.3.1.13 Modbus	57
7.3.1.14 QMA	58
7.4 Calibration Menu	59
7.5 Diagnostics Menu	61
7.5.1 Analog input.....	61
7.5.2 Analog output.....	61
7.5.3 Digital output	62
7.5.4 LDepc.....	62
7.5.5 Modbus/Register	63
7.5.6 Modbus/Connection.....	63
7.5.7 Idle Sensor	63
7.6 Regeneration	64
7.7 About menu.....	65
7.8 Firmware Update	65
8.0 Backpanel terminal identification	66
9.0 Drawings & Schematics.....	68
10.0 Maintenance	71
10.1 Spare part list	71
10.2 Frequently asked questions	71

Table of Figures

Figure 1: Boot up screen.....	11
Figure 2: Boot up alerts.....	12
Figure 3: Oven setpoint.....	13
Figure 4: Flow setpoint.....	14
Figure 5: Sensor - Operating Parameters.....	15
Figure 6 : Typical Installation.....	19
Figure 7 : Same source actuation.....	21
Figure 8 : 2 sources actuation.....	22
Figure 9 : O2 doping.....	24
Figure 10 : Type of Detectors.....	25
Figure 11 : MultiDetek 2 printed circuit board (PCB).....	26
Figure 12 : Solenoid proportional valve.....	27
Figure 13 : Diaphragm valve.....	27
Figure 14 : LDepc.....	28
Figure 15 : Isothermal and programmable oven.....	28
Figure 16 : 8.4" Touch screen LCD.....	29
Figure 17: Built-in sample purging and monitoring system.....	29
Figure 18: Compact LDP-1000.....	31
Figure 19: Machine Manager.....	32
Figure 20: Method Manager.....	33
Figure 21: Network.....	34
Figure 22: Chromatogram menu.....	35
Figure 23 : Solenoid proportional valve.....	36
Figure 24: Bottom bar.....	36
Figure 25: Left bottom bar.....	37
Figure 26: Middle bottom bar.....	38
Figure 27 : Alerts windows.....	38
Figure 28 : Historic menu.....	39
Figure 29 : Historic list window.....	40
Figure 30: Peak Results.....	40
Figure 31: Peak detection menu.....	40
Figure 32 : Settings menu.....	42
Figure 33: Peak setting menu.....	43
Figure 34: Flow setting menu.....	45
Figure 35: Oven setting menu.....	47
Figure 36: Detector setting menu.....	49
Figure 37: Sensor setting menu.....	50
Figure 38: Valve setting menu.....	51
Figure 39: Machine setting menu.....	52
Figure 40: 4-20mA settings menu.....	53
Figure 41: Stream settings menu.....	54
Figure 42: Sequence setting menu.....	55

Figure 43: Column setting menu.....	56
Figure 44: Modbus setting menu	57
Figure 45: QMA setting menu	58
Figure 46: Calibration menu	59
Figure 47: Analog input window	61
Figure 48: Analog output window	61
Figure 49: Digital output window.....	62
Figure 50: LDepc diagnostic window.....	62
Figure 51: Modbus register window	63
Figure 52: Modbus information window	63
Figure 53: Regeneration window.....	64
Figure 54 : About menu	65
Figure 55 : Firmware Update.....	65

1. Forewarning

This manual is required to be read by any user that wants to use the MultiDetek 2 Trace Impurity analyzer. It contains important information to successfully operate this instrument. LDetek makes the assumption that all operators have taken the time to read this information prior to installation, operating and troubleshooting this analyzer.

If any error is suspected by the reader, please contact LDetek. LDetek reserves the right to make any changes to subsequent editions of this document without prior notice to holders of this edition.

We want to thank you for choosing LDetek as your gas analyzer supplier.

2. Warranty, maintenance and service policies

Goods and part(s) (excluding consumable) manufactured by the seller are warranted to be free from defects in workmanship and material under normal use and service for a period of **twelve (12)** months after installation and start-up and not exceeding **18 months** from shipment date. Consumable, chemical trap, O-rings, etc., are warranted to be free from defects in workmanship and material under normal use and service for a period of ninety (90) days from the date of shipment by the seller. Goods, part(s) proven by the seller to be defective in workmanship and/or material shall be replaced or repaired, free of charge, F.O.B. Seller's factory provided that the goods, part(s) are returned to Seller's designated factory, transportation charges prepaid, within the twelve (12) months after installation and start-up and not exceeding 18 months from shipment date. In the case of consumable; within the ninety (90) days period of warranty, a defect in goods, part(s) and consumable of the commercial unit shall not operate to condemn such commercial unit when such goods, part(s) and consumable are capable of being renewed, repaired or replaced.

The Seller shall not be liable to the Buyer, or to any other person, for the loss or damage directly or indirectly, arising from the use of the equipment of goods, from breach of any warranty, or from any other cause.

ALL OTHER WARRANTIES, EXPRESSED OR IMPLIED ARE HEREBY EXCLUDED.

IN CONSIDERATION OF THE HEREIN STATED PURCHASE PRICE OF THE GOODS, SELLER GRANTS ONLY THE ABOVE STATED EXPRESS WARRANTY. NO OTHER WARRANTIES ARE GRANTED INCLUDING, BUT NOT LIMITED TO, EXPRESS AND IMPLIED WARRANTIES OF MERCHANTABILITY AND FITNESS FOR A PARTICULAR PURPOSE.

THIS WARRANTY IS THE ONLY WARRANTY MADE BY LDETEK INC. WITH RESPECT TO THE GOODS DELIVERED HEREUNDER, AND NO EMPLOYEE, REPRESENTATIVE OR OTHER PERSON OR ENTITY IS AUTHORIZED TO ASSUME FOR LDETEK INC ANY OBLIGATION OR LIABILITY BEYOND OR AT VARIANCE WITH THIS WARRANTY IN CONNECTION WITH THE SALE OF LDETEK PRODUCTS.

Limitations of Remedy. SELLER SHALL NOT BE LIABLE FOR DAMAGES CAUSED BY DELAY IN PERFORMANCE. THE SOLE AND EXCLUSIVE REMEDY FOR BREACH OF WARRANTY SHALL BE LIMITED TO REPAIR OR REPLACEMENT UNDER THE STANDARD WARRANTY CLAUSE. IN NO CASE, REGARDLESS OF THE FORM OF THE CAUSE OF ACTION, SHALL SELLER'S LIABILITY EXCEEDS THE PRICE TO BUYER OF THE SPECIFIC GOODS

MANUFACTURED BY SELLER GIVING RISE TO THE CAUSE OF ACTION. BUYER AGREES THAT IN NO EVENT SHALL SELLER'S LIABILITY EXTEND TO INCLUDE INCIDENTAL OR CONSEQUENTIAL DAMAGES. CONSEQUENTIAL DAMAGES SHALL INCLUDE BUT ARE NOT LIMITED TO, LOSS OF ANTICIPATED PROFITS, LOSS OF USE, LOSS OF REVENUE, COST OF CAPITAL AND DAMAGE OR LOSS OF OTHER PROPERTY OR EQUIPMENT. IN NO EVENT SHALL SELLER BE LIABLE FOR PROPERTY DAMAGE AND/OR THIRD PARTY CLAIMS COVERED BY UMBRELLA INSURANCE AND/OR INDEMNITY COVERAGE PROVIDED TO BUYER, ITS ASSIGNS, AND EACH SUCCESSOR INTEREST TO THE GOODS PROVIDED HERE UNDER.

Major force. The seller is not liable for failure to perform due to labour strikes or acts beyond the seller's direct control.

SERVICE POLICY

1. If a product should fail during the warranty period, it will be repaired free of charge. For out of warranty repairs, the customer will be invoiced for repair charges at current standard labour and materials rates.
2. Customers who return products for repairs, within the warranty period, and the product is found to be free of defect, may be liable for the minimum current repair charge.
3. For parts replacement, the original part must be returned with serial and model numbers of the analyzer. **NO PART WILL BE SHIPPED IF THE ORIGINAL IS NOT SENT BACK TO LDETEK INC.**

RETURNING A PRODUCT FOR REPAIR

Upon determining that repair services are required, the customer must:

- ❖ Obtain an RMA (Return Material Authorization) number;
- ❖ Supply a purchase order number or other acceptable information;
- ❖ Include a list of problems encountered along with name, address telephone, and RMA number;
- ❖ Ship the analyzer in its original crating or equivalent. Failure to properly package the analyzer will automatically void the warranty;
- ❖ Every gas connection must be capped with appropriate metal caps. Failure to do so, it will automatically void the warranty;
- ❖ Write RMA number on the outside of the box;
- ❖ Use an LDetek approved carrier. Also, the delivery must be sent to LDetek facilities. LDetek will not accept airport to airport delivery;
- ❖ LDetek will not cover the transportation fees.

Other conditions and limitations may apply to international shipments.

PROPRIETARY RIGHTS

Buyer agrees that any LDetek's software, firmware and hardware products ordered or included in the goods ordered are proprietary of LDetek. No change, modification, defacement, alteration, reverse engineering, neither software de-compilations nor reproduction of such software or hardware products, or disclosures of programming content to other parties is authorized without the express written consent of LDetek.

To maintain LDetek's trade secret and other proprietary protection of such software and firmware, such items are not sold hereunder but are licensed to the buyer.

LDetek Inc. reserves the right to interrupt all business relationship and warranty or service if there is any tentative from any customers to reverse engineering any of LDetek products or to tamper with any sealed module.

Trademarks and product identification as MULTIDETEK 2 are the property of



LDetek Inc. and shall be used only in connection with LDetek's products. No third party could remove or deface any model number or marks.

3. Declarations of conformity

EU Declaration of Conformity



1. **Product model:** MultiDetek 2 Compact gas chromatpgraph

2. **Name and address of the manufacturer:**

LDetek Inc.
990 Monfette E.
Thetford Mines, QC G6G 7K6
+1 (418) 755-1319
Email: info@ldetek.com

This product is in conformity with the following EU Directives ,Standard(s) or Normative Document(s):

3. **Directives.**

Low Voltage Directive (LVD) 2014/35/EU,

Electromagnetic Compatibility Directive (EMC) 2014/30/EU,

Restriction of Hazardous Substances (RoHS) Directive 2011/65/EU/2014/68/EU

Pressure Equipment Directive

This product does not bear CE marking for the Pressure Equipment Directive, but are supplied in accordance with Article 4, paragraph 3 of 2014/68/EU by using SEP (sound engineering practice) in the design and manufacturer and are provided with adequate instructions for use.

4. **Standards:**

EN61326-1:2013 Electrical equipment for measurement, control and laboratory use – EMC requirements –Class B (emissions) and Industrial Locations (immunity).

EN61010-1:2010 Safety Requirements for Electrical Equipment for Measurement, Control, and Laboratory Use - Part 1: General Requirements

5. **On behalf of the above-named company, I declare that under our sole responsibility, on the date that the equipment accompanied by this declaration is placed on the market, it conforms with all technical and regulatory requirements of the above listed EU Directives.**

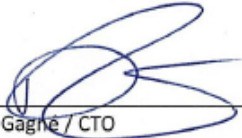
Dany Gagné / CTO
Thetford Mines, QC
Date: 06/21

990, rue Monfette Est, Thetford Mines G6G 7K6
Tél. 418 755-1319, Tél. 418 755 1329

UK Declaration of Conformity



1. **Product model:** MultiDetek 2 Compact gas chromatograph

2. **Name and address of the manufacturer:**

LDetek Inc.
990 Monfette E.
Thetford Mines, QC G6G 7K6
+1 (418) 755-1319
Email: info@ldetek.com

This product is in conformity with the following UK Directives ,Standard(s) or Normative Document(s):

3. **Directives.**

Electrical Equipment (Safety) Regulations 2016 : S.I. 2016:1101

Electromagnetic Compatibility Regulations 2016: S.I. 2016:1091

The Restriction of the Use of Certain Hazardous Substances in Electrical and Electronic Equipment Regulations 2012 : S.I. 2012:3032

Pressure Equipment (Safety) Regulations 2016: S.I. 2016:1105

4. **On behalf of the above-named company, I declare that under our sole responsibility, on the date that the equipment accompanied by this declaration is placed on the market, it conforms with all technical and regulatory requirements of the above listed UK Directives.**



Dany Gagné / CTO
Thetford Mines, QC
Date: 08/21

4. Specifications

Detector type:	PED (PlasmaDetek), FID, TCD or third party detector can be mounted on request
Carrier:	Argon, Helium, Nitrogen, Hydrogen, Neon or others
Range:	Application dependant
Repeatability:	< 5% of (3*CV%)
Accuracy:	Better than $\pm 1\%$ error or LDL whichever is higher
Standard features:	<ul style="list-style-type: none"> Range (manual) Microprocessor controlled (DSP) Windows 7 embedded user friendly interface Ethernet port for remote control Isothermal and/or programmed ramping ovens Electronic flow control regulators for carrier & sample gases 8.4" LCD large touch screen Self-diagnosis system with auto-resolve alarm 10 x 4-20 mA isolated output 10 x Range contacts Alarm Historic Digital system status output for remote monitoring (dry relay contact) Range ID relay 2 alarms contacts
Options:	<ul style="list-style-type: none"> 1 High resolution chromatogram output Serial port: RS-232 / 422 / 485 / Profibus for monitoring 2 x analog inputs or/and 1 digital input 8 contacts for remote streams control 1 extra contact 1 x Auxiliary oven control Net Support, purged valve box, heated valve box, leak monitoring system, etc
Gas connections:	<ul style="list-style-type: none"> Sample: 1/8" compression fittings or 1/8" VCR Vent: 1/8" compression fitting
Calibration gas:	Span: 70% to 90% of the full scale
Sample pressure:	5 to 30 PSIG
Carrier pressure:	100 PSIG
Operating temperature:	10 °C to 45 °C
Supply:	115 VAC, 50 – 60 Hz or 220 VAC, 50 – 60 Hz
Power consumption:	Maximum 400 Watts
Cylinder temperature range	0 °C to 45 °C

5. Cautions and installation information

5.1 Detector cautions

The MultiDetek2 uses multiple detection techniques known from the industry for many years. It can be PED, FID, TCD, DID and other types on request.

PED

The principle of the PED is based on spectroscopic emission. The detector is a pure quartz cell put in an electromagnetic field created by a specific high-intensity generator. This electromagnetic field creates plasma that emits light to different wavelengths. Appropriate optical filter is used to detect the gas desired. The major advantage of the PED is to offer selective mode based on the spectral line used to measure specific impurities. Such PED offers selectivity and sensitivity.

Since the cell is made of thin quartz, this analyzer vent must be used in **ATMOSPHERIC PRESSURE TO AVOID ANY CELL CRACKING**. Any back pressure to the detector vent connection will cause damage and replacement of the plasma detector module. Such PED requires no maintenance.

FID

The principle of the FID is based on ionization of carbons using a flame. The flame is maintained, using a mixture of hydrogen and air at a specific ratio pre-configured in Factory. The FID body has to be cleaned up depending on every application. The FID is used for analysis of carbons at different concentrations.

TCD

The principle of the TCD is based on thermal conductivity of the gases through a Wheatstone bridge. The carrier gas plays an important role due to the thermal conductivity of the desired impurities to be analyzed. It is why multiple carrier gas can be used to cover multiple impurities. The TCD is used to measure high concentration since it is not sensitive at low concentration.

DID

The principle of the DID is based on the ionization of the molecules. The detector has its discharge area that is made of quartz to create an ionization zone and it's used to create photons. The photons are used to ionize the sample molecules and then create ions that are captured by electrodes, when sample is introduced in the detector. The DID is a universal detector offering multiple applications.

5.2 Analyzer application

The MultiDetek2 is designed to be used **for the impurity and sampling details on the specification sheet of the instrument only**. Using this instrument with any other type of gases can cause damage to the analyzer. Please refer to the document “Operating Parameters” that comes with the unit.

The MultiDetek2 is not an instrument to be used in hazardous area.

5.3 Start-up

All LDETEK products are properly packed in a cardboard box and all instruments come with an associate document name “Operating parameters”. Refer to the steps below to ensure the proper start-up for this unit.

1. Unpack the instrument carefully from the box and inspect it to be sure it is in good condition and hasn't been damaged during shipping.
2. Find the documents of the instrument, USB key, fuse kit and power cables that are all included in every box.
3. The unit can be installed on a table or mounted in a rack. If it is mounted in a rack, refer to section 8.0 for drawings to evaluate the good panel cut out and space required.
4. Once the unit is in place, it is required to install and purge the carrier gas lines prior to connect them to the MultiDetek2. The carrier gas type and pressure to respect are mentioned in the document “Operating Parameters”. For gas lines connections, refer to the tubing schematic that comes with the unit.
5. The LDP1000 gas purifier has to be purged. Refer to the LDP1000 installation procedure to ensure that it is properly installed.

6. When the LDP1000 gas purifier is purged and ready, the gas lines can be connected to the back panel connections of the MultiDetek2. It is very important to remove all the caps from the gas connections installed on the MultiDetek2 back panel. **Any back pressure to the detector vent connection will cause damage and replacement of the plasma detector module.**
7. Once the gas lines are purged and gas is connected to the MultiDetek2 unit, the power source can be connected. Please refer to the model number of the instrument that shows the voltage of it (120VAC or 240VAC). Further, the red indicator on the power inlet module on the back panel must have the same voltage indication than shows in the model number. **Introducing the wrong power voltage source can severely damage the instrument.**
8. Turn ON the unit by switching on the back panel switch and wait for unit booting. The MultiDetek2 works with Windows based environment. LDChroma will start automatically after the start-up. It takes about 2 minutes for start-up. See below the Chromatogram screen that appears after each boot up.

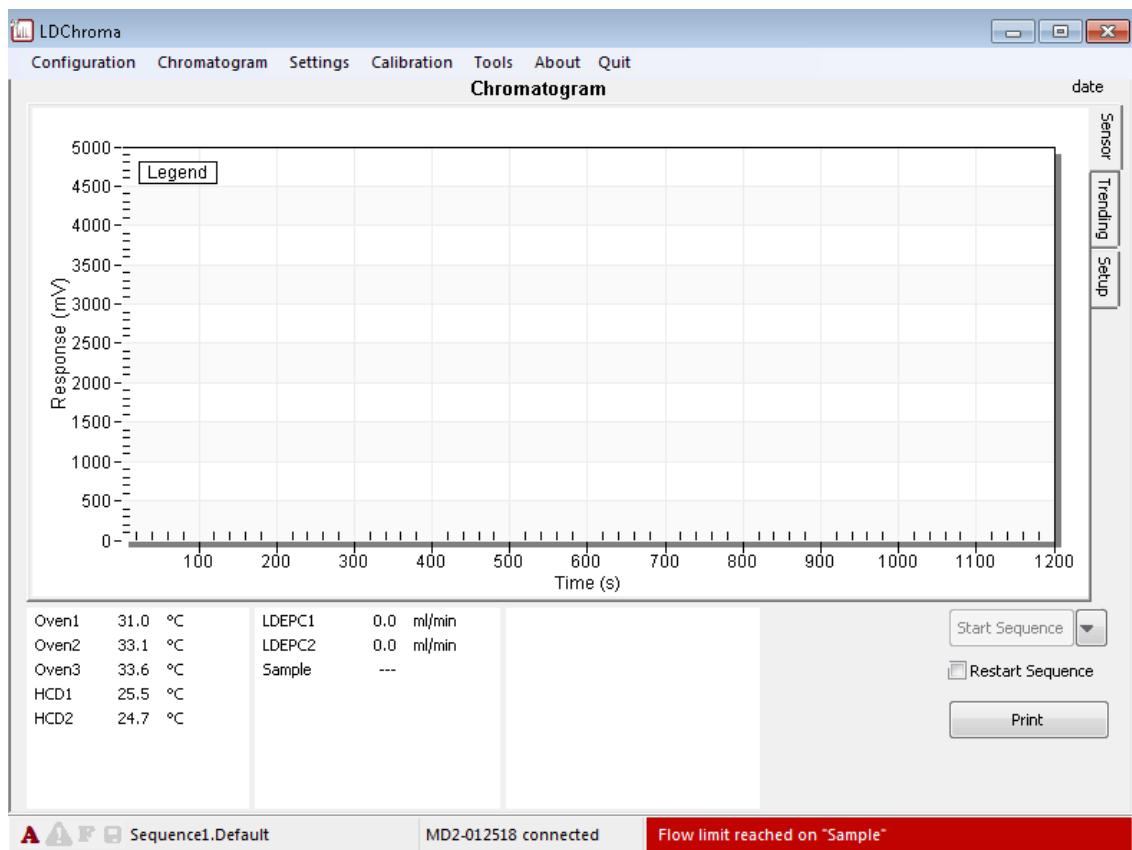

Figure 1: Boot up screen

9. Every active alerts except “Sample Low Flow” must be resolved before going further. Double-click on the red alert bar and check the alerts. See Alerts menu for reference below.

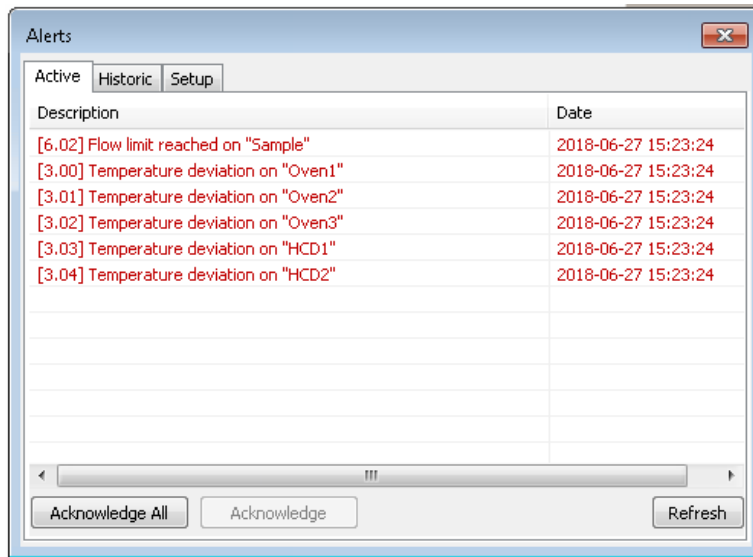

Figure 2: Boot up alerts

Below are the principal alert you may encounter:

Temperature deviation on oven #: This type of alert will be solved automatically after few minutes. It is the time required for the initial start-up to heat up the ovens. The set points to achieve are written in the datasheet of the instrument. You can also confirm the oven set points by going in the menu Settings>>Oven select the right oven and look at the first value of the time table (beside “at start”). If after few minutes, the oven temperature deviation is still active and no temperature change occurred, then it is required to contact LDeTek support for further instructions.

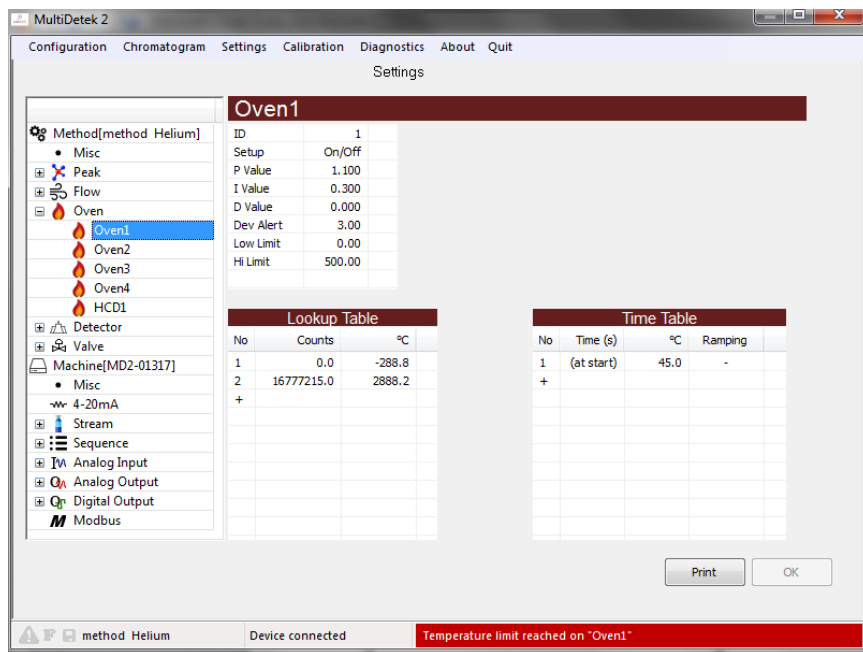

Figure 3: Oven setpoint

Flow deviation on LDepc #: This type of alert will be solved automatically after few minutes. It is the time required for initial start-up to stabilize the pressure flow controller(s). The set points to achieve are written in the datasheet of the instrument. You can also confirm the carrier set points by going in the menu Settings>>Flow select the right flow and look at the first value of the time table (beside “at start”). If after few minutes, the alert is still active and no flow change occurred, then it is suggested to ensure the carrier gas pressure at the carrier inlet of the MultiDetek2 is set at 100PSIG as wrote in the datasheet. Make sure nothing add restriction between carrier source and carrier inlet of the analyser. If After confirming the above you still have an active ‘Flow deviation alert on LDEPC#’ displayed, then it is required to contact LDeTek support for further instructions.

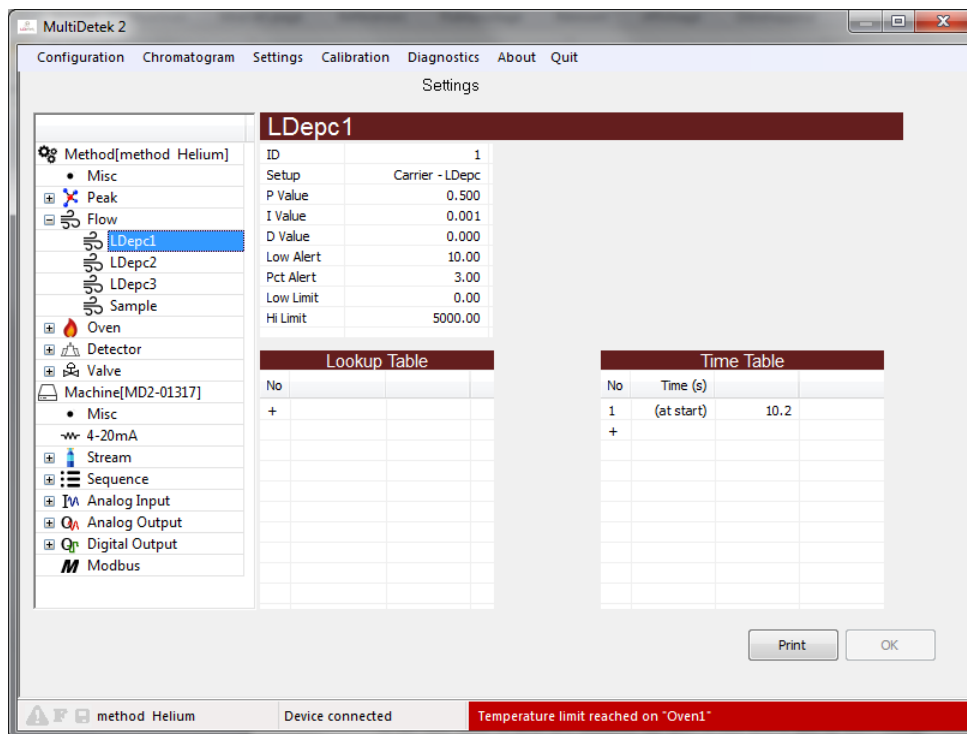

Figure 4: Flow setpoint

Low flow on sample: This type of alert will be solved automatically after few minutes. It is the time required for initial start up to stabilize the pressure flow controller. The set points to achieve are written in the datasheet of the instrument. You can also confirm the sample set points by going in the menu Settings>>Flow select the right flow (sample) and look at the first value of the time table (beside “at start”). If after few minutes, the sample flow deviation alert is still active and no sample flow change occurred, then it is suggested to ensure the sample gas pressure at the sample inlet of the MultiDetek 2 is set generally between 5PSIG and 30PSIG as wrote in the datasheet. Make sure nothing add restriction between sample source and sample inlet of the analyser. If after confirming the above you still have an active “Low flow on sample” alerts are display, then it is required to contact LDeTek support for further instructions.

Detector # off: This type of alert will be solved automatically after few minutes. It is the time required for initial start up to stabilize and purge the unit to finally permit detector(s) ignition. The detector will turns on automatically once the carrier gas set points and a basic purge of the system are achieved. If after confirming the above you still have an active ‘Detector # OFF’ alerts displayed, then it is required to contact LDeTek support for further instructions.

10. It is now necessary to wait a period of minimum 2-3 hours to partially purge the system. A good purge required a period of 12-24 hours depending on system configuration. It can takes longer for a ppb system (<500ppb).

The best way to know if the system is well purged is to compare the detector signals of the system with the ones that appear on the document named "Operating Parameters". The voltages can be seen by clicking on Tools >> Diagnostics >> Analog Input >> Page 3. The general rule is the signal must be within +/-25% of the document values. See an example of a chart that appears in every document operating parameters. The number of sensor is dependent on the MultiDetek 2 method.

Diagnostic / Sensor Counts

Detector 1

Sensor 1	Leak + N2	1121000 Counts	668 mV
Sensor 2	H2, CH4, C2H6	4132000 Counts	2436 mV
Sensor 3	CO, CO2	4433000 Counts	2624 mV
Sensor 4	O2	1209200 Counts	720 mV

Figure 5: Sensor - Operating Parameters

11. After purging of the system, the span bottle must now be connected at the appropriate inlet and analyze by the system. The span bottle specification to use should be within a range of 70% to 90% of the full scale range of measurement of the instrument for each impurity. The balance gas of this cylinder should be the same than carrier gas or the advised balance gas of the method that the analyser is built for.

For example, if the analyzer is configured for measurement of 0-10ppm Ar and 0-50pm N2 in Balance Oxygen. Then you can use a certified span gas containing between 7ppm-9ppm Ar and between 35ppm-45ppm N2 in balance Oxygen or in the same gas as the carrier gas.

The sample gas pressure to respect are mentioned in the document "Operating Parameters". Once the sample gas connected, the alarm "Sample Low Flow" will disappear. When the alerts are all resolved, the red alert bar in the bottom will disappear.

Once the sample lines are properly purged with span gas, simply start a cycle in the chromatogram menu. At the end of the analysis, it is important to look at the chromatogram to make sure all peak(s) fit completely in their respective window(s). If some peaks aren't perfectly integrated into their respective window, restart the analysis several times. If the problem still occurred, then it is required to send the exported machine file (.md2m) to LDefetek support for further instructions. Refer to chapter 6.1.1 of this manual for further details on Machine file exporting.

Due to the vibrations during shipping, sometimes the system properties are modified and could result changing in the elution time of peaks. In this case, LDetek experts will be able to guide you in the modification of the system parameters with the file provided.

12. When all peaks appear at the right timing using the span gas, the span calibration of the system can be done. Refer to section 6.4 of this manual for calibration menu details.
13. After running the span calibration, the system can be switched on process gas and is ready for normal operation.

5.4 Shut-off

The MultiDetek2 must always be purged with carrier gas. Leaving the system without carrier gas may result in air contamination that could damage the analyzer permanently.

If the system needs to stoped, the connections on the back panel must be capped. Make sure the carrier gas was closed prior because **any back pressure to the detector vent connection will cause damage and replacement of the plasma detector module**. Refer to the steps below to ensure the proper shut-off of the unit.

1. In LDChroma, make sure you are in Admin mode. If needed, refer to section 7.1.5 User and Admin Mode.
2. Once in admin mode, click on "Quit". A window will pop-up asking you if you want to power off the system. Click on "Ok" and the panel PC will turn OFF.
3. It takes 30 seconds for the panel PC to close. Once it is power OFF, the green LED at the bottom right of the screen will turn OFF. You can now turn OFF the unit by switching the back panel switch.
4. Close the sample gas supply by closing the cylinder or any other valve that control it.
5. Disconnect the sample inlet and sample outlet tubes from the analyzer back panel.
6. Decrease the carrier gas pressure to 20 psi and disconnect the carrier inlet tube from the analyzer back panel.
7. Put a male cap over the carrier inlet tube that was removed.
8. Remove all the remaining vents tubes on the back panel.

9. All the caps can be installed on the MultiDetek2 back panel.
10. Remove the power from the LDP1000 by switching its power switch to OFF and disconnect the power cable on the LDP1000.
11. Wait until the LDP1000 become at ambient temperature. It takes around 2 hours.
12. Remove the tube connected at the outlet connection of LDP1000 and quickly cap the outlet connection of the purifier with a female cap.
13. Remove the tube connected at the inlet connection of LDP1000 and quickly cap the inlet connection of the purifier with a female cap.
14. Shutdown the carrier gas source on the cylinder or tank.

5.5 Typical installation

5.5.1 Carrier gas

Figure 6 shows a typical example of a GC plumbing diagram having a carrier gas supply configured with an automatic switchover system. The demonstrated system also includes a stream selector system allowing the different streams to be selected for analysis. Also, an Oxygen doping system has been added for the purpose of trace O₂ detection by the GC (refer to our document section 4.5.3 O₂).

Generally speaking, Argon or Helium or Nitrogen are used as carrier gas for GC. Their physical properties make these gases the top choices for using in the gas chromatography. The carrier gas must be continuously flowing without interruption at the required flow and pressure rates to be able to keep the GC working properly. The carrier gas is used to carry the sample gas to the chromatographic columns and gas detectors. Therefore, the purity of the carrier gas is very important to avoid contamination of the GC components and blocking of the flow path inside the GC.

In order to maintain this equilibrium inside the analyzer, it is required to install a certified minimum grade of carrier gas of purity 99.999% (grade 5.0). This grade is certified to have a maximum concentration of 10ppm total impurities in it and we must combine it with a filter type heated gas purifier LDP1000. This device generates grade 99.999999% (grade 9.0) from a starting grade 5.0. Having more poor-quality inlet grade to the purifier may damage the unit, reduce its lifetime and cause severe risk of damaging the GC. As demonstrated in Figure 6, an automatic switchover system is required to automatically switch on the full carrier gas cylinder when the empty carrier gas bottle has hit the low 200-250psig pressure level inside the bottle. This automatic switchover system ensures

there is no carrier flow interruption in the system which is the most critical point. Once the system has switched on the backup bottle, it is the responsibility of the user to replace the empty bottle. The lifetime of a carrier bottle is application dependent but as an indication, a small to mid-size GC system requires a 50Liters (9cubic meters) bottle once a month.

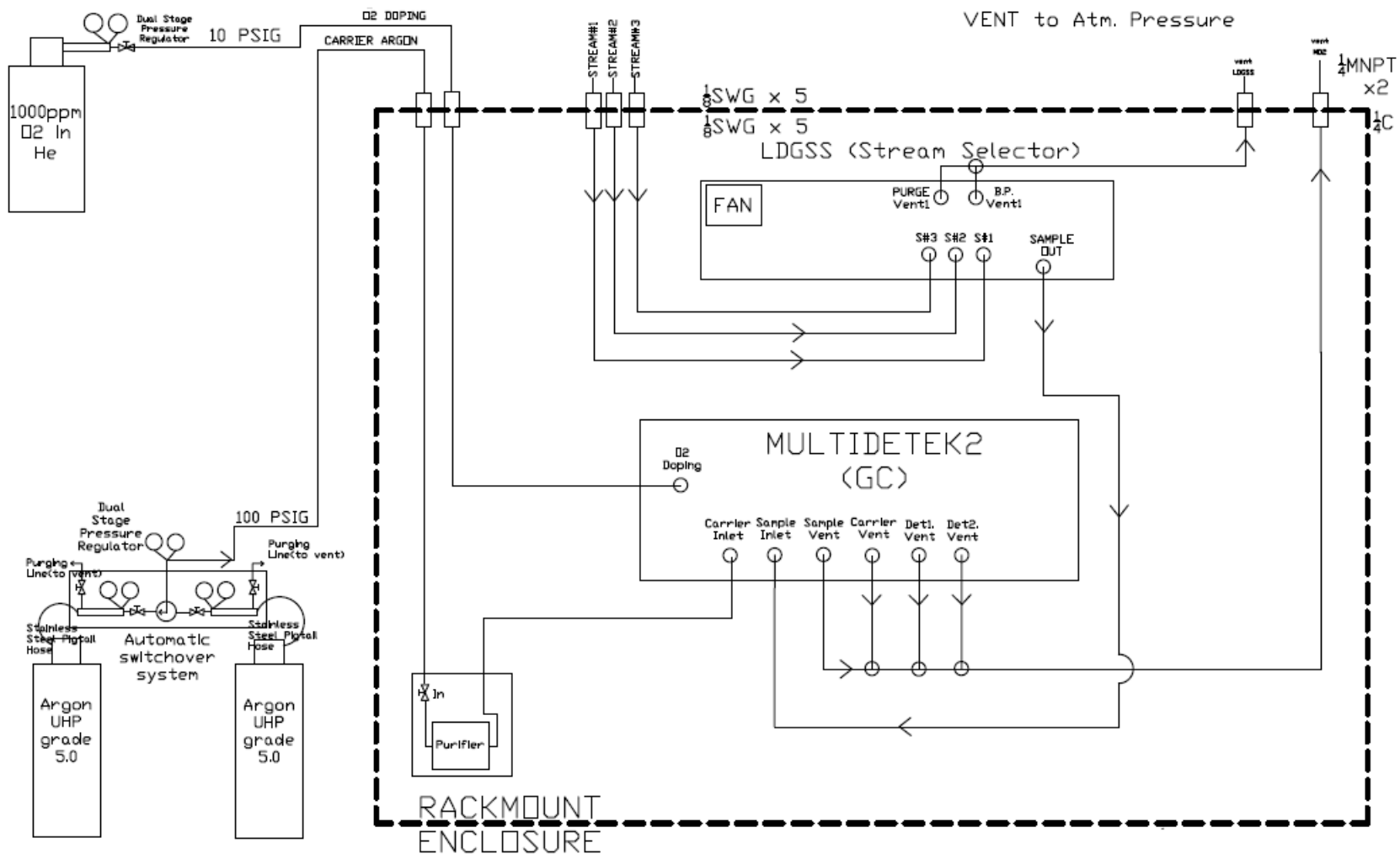

Figure 6 : Typical Installation

5.5.2 Valves actuation

Separating the actuation from the reference carrier gas allows our gas chromatograph MultiDetek2 to achieve better results and more stability. The reason for it is mainly caused by the pressure changes when valves actuate during a cycle that will impact the equilibrium of the carrier gas reference. This will result in baseline fluctuations in the signal what will change the response to the detector. Such events are more visible when low ppb analysis is required. This is due to the high level of the sensitivity required for such applications.

Figure 7 and 8 shows a typical example of a GC plumbing diagram having a carrier gas supply configured with an automatic switchover system. Both figures show a different way to make the gas connections to the actuation. The demonstrated system also includes a stream selector system allowing the different streams to be selected for analysis.

It is important to use an actuation gas having the same specifications as the carrier gas. This is to avoid any phenomenon that could occur by mixing between the actuation and carrier gas resulting in faulty events.

Figure 7 is the low cost and easiest way to interconnect the actuation gas to the carrier gas source using a tee. This technique avoids the need for installing a second source of gas for actuation. Having a reasonable long volume of piping externally to the GC system act like a buffer that will absorb the pressure shocks during valve actuation.

Figure 8 is the high-class technique to feed a GC system with two separate sources. This way, the system is completely independent of any variation caused by valve actuation. This is strongly suggested for low ppb applications where extreme stability is required to achieve a high level of sensitivity. A second double stage/stainless steel pressure regulator is mounted on a gas bottle being the same type of gas as the carrier gas type.

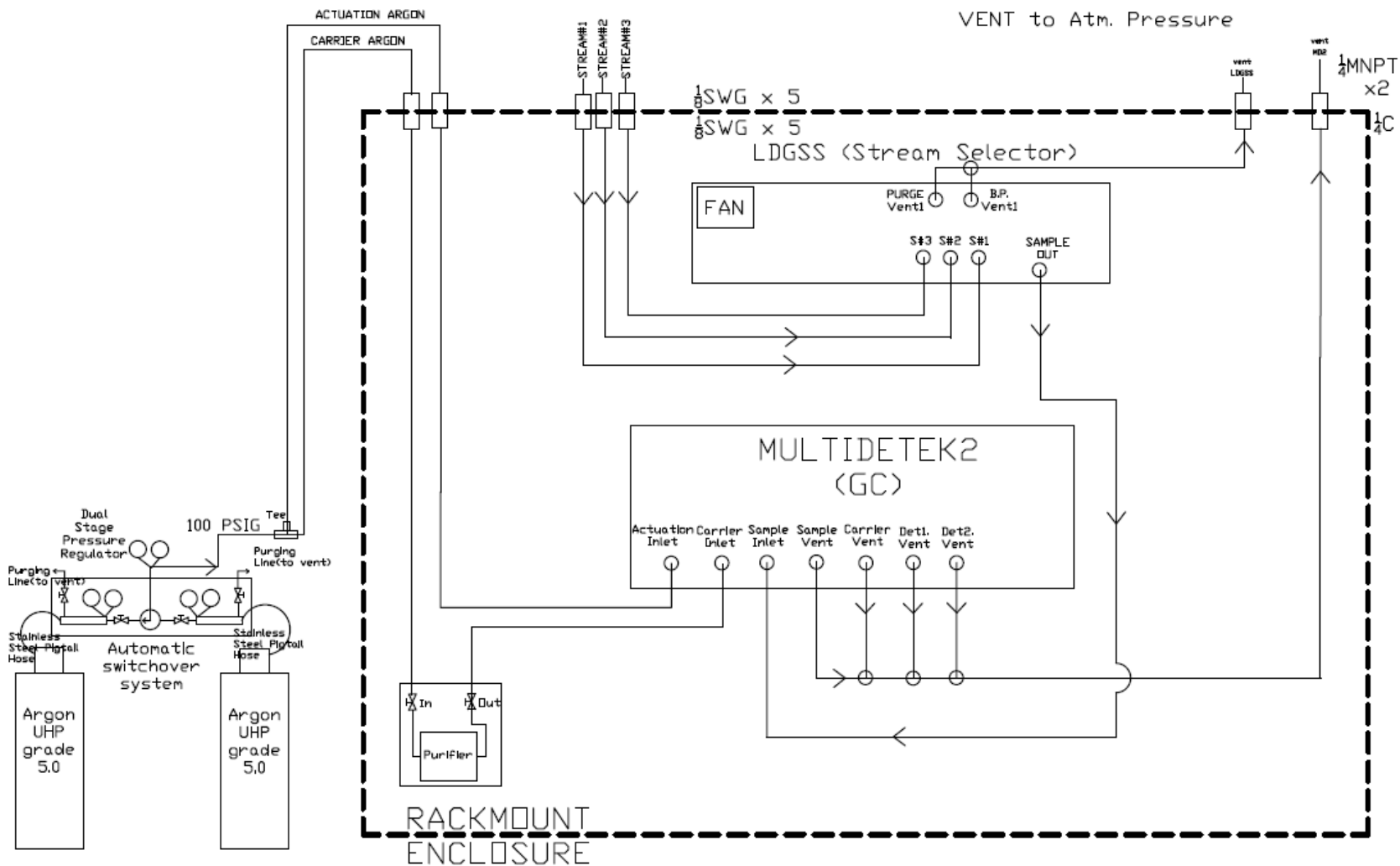

Figure 7 : Same source actuation

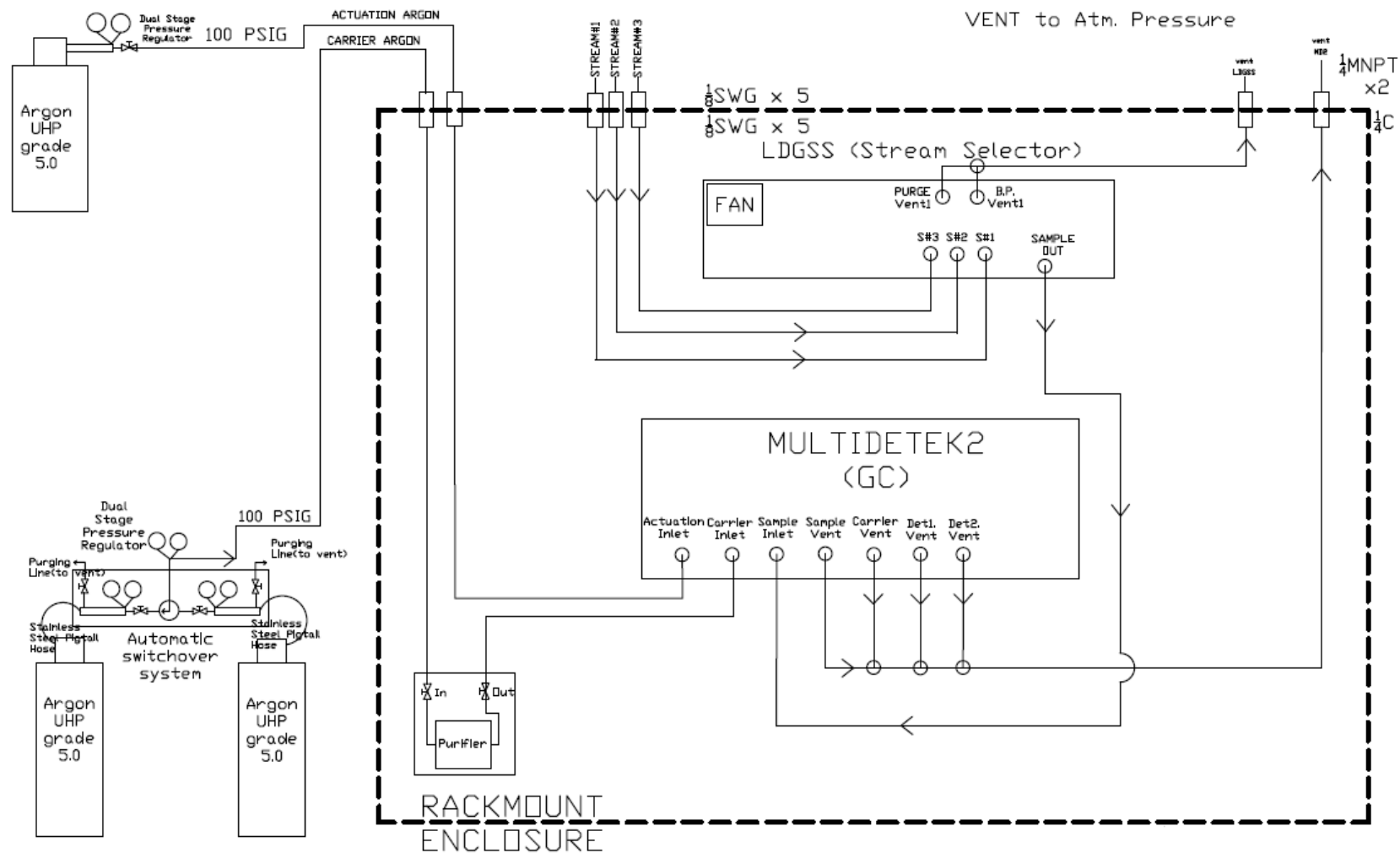

Figure 8 : 2 sources actuation

5.5.3 O₂ doping

Figure 6 shows a typical installation that requires O₂ doping. This feature is used to keep our system saturated with Oxygen. In chromatography, it is well known that oxygen is adsorbed by the Molecular Sieve and also by the porous polymer type columns used for separating and measuring trace oxygen. Even if a good column activation is performed at the beginning, over time the oxygen will slowly desorb from the column and the column will start to adsorb the oxygen content coming from the volume of sample gas injected. This phenomenon has a big impact on the analysis accuracy for measuring Oxygen at ppm/ppb due to a part of the sample staying inside the columns. It generally results in a loss of the ppb/ppm peak of Oxygen even on the span calibration gas. By adding an Oxygen doping gas, the active sites inside the columns are permanently filled with Oxygen. It stabilizes the system and ensures a good reproducibility and accuracy resulting in better sensitivity.

Figure 9 shows a typical example of a GC plumbing diagram having an O₂ doping option. Valve 10 is a 2 streams selector that switches between the sample gas and the doping gas. The doping gas must be connected to a certified gas bottle containing a known concentration between 100-1000ppm O₂ in a balance gas being the same as the carrier gas. The pressure of that said bottle must be set at a value between 10-30psig. Depending on the GC application, the flow consumption of the doping gas will be as low as 100scm for a period varying from 2-7 minutes per cycle depending on the GC configuration. Such a bottle can last for a long period before needing to be replaced.

Valve 10 is switching to the doping gas during an analysis cycle at a moment following the elution of the measured impurities in the channel used to measure the trace oxygen. Generally, the sampling loop of this channel is the first to be injected to ensure that the oxygen doping gas can be injected as quickly as possible, eventually being flushed out of the system rapidly. This is the reason why the time that the doping gas is in the loops varies from 2-7 minutes. It is application dependent, but we always try to minimize it during our tuning process. By the time the analysis of the other impurities is progressing, the oxygen doping gas is flowing through the columns of interest for saturating them with oxygen. By going this way, automatically every cycle, the system stays in good condition for measuring oxygen.

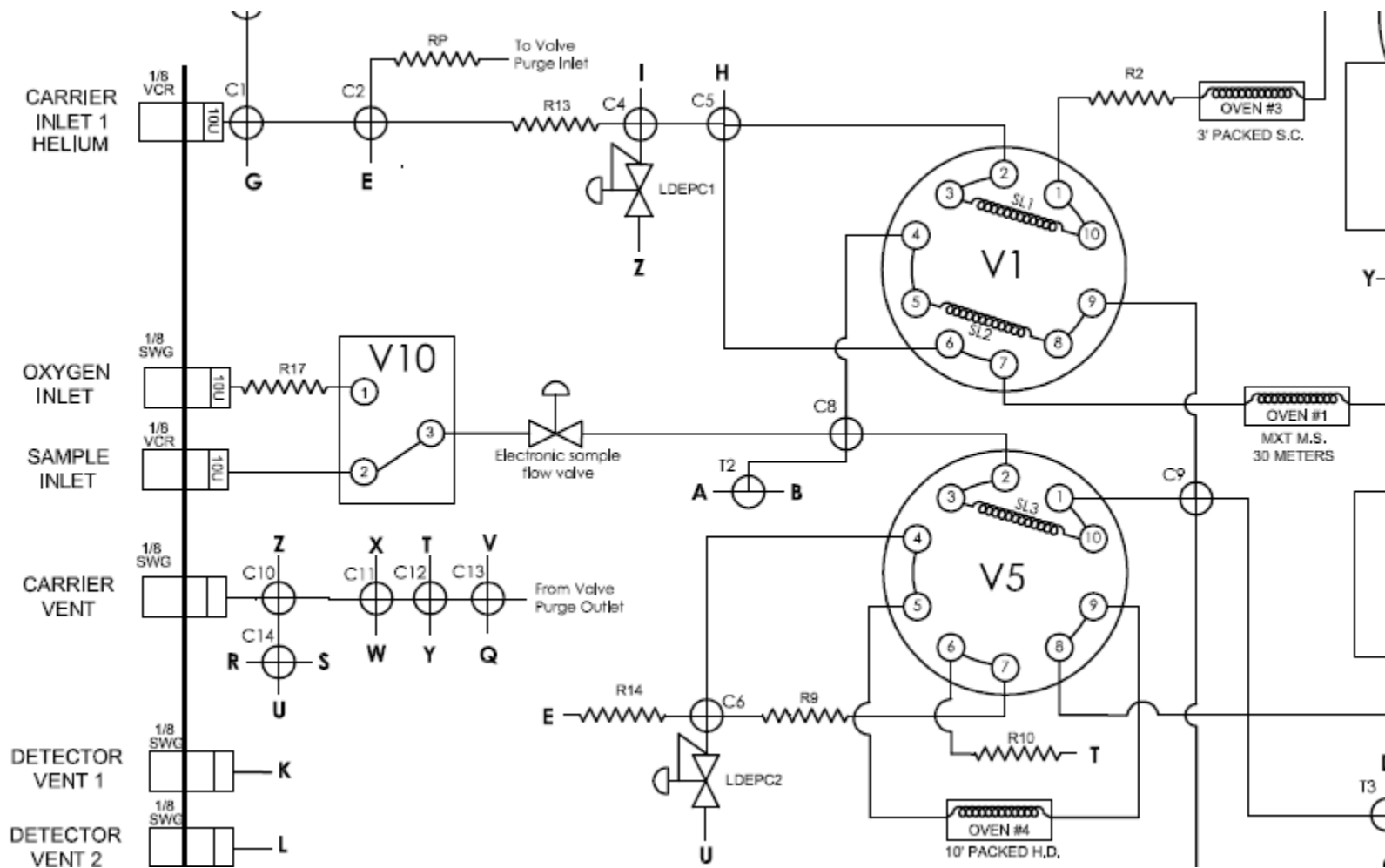

Figure 9 : O₂ doping

6. Hardware description

The MultiDetek 2 has major components included in its chassis. This section will describe each component that can be replaced for maintenance or upgrade.

6.1 Detectors

The **PED** detector module is a 155 mm (6.1") x 82 mm (3.22") x 63 mm (2.48") box that contains all components needed to proceed to accurate measurement. The MultiDetek 2 can accept up to 3 PEDs in the same chassis. This module is maintenance free. The PED is a very sensitive and selective detector perfect for trace impurities. It can only be defective if the detector has been pressurized or contaminated with liquid or high concentration hydrocarbons. The PED design is modular and can be easily replaced on site.

The **FID** detector is used for measuring hydrocarbons and its design makes it suitable for easy operation. The maintenance is easy since it offers an easy access. As any FID, maintenance consists of cleaning the interior of the detector. Its compact design makes possible to install up to 2 FID in the same MultiDetek 2 chassis or in combination with other detectors.

The **TCD** is used for measuring high percent impurities to be complementary to the PED detector. It can be installed in series or parallel with the PED and then offering a very wide dynamic range of measurement. The TCD is also modular and is easy to manipulate for maintenance purpose if required.

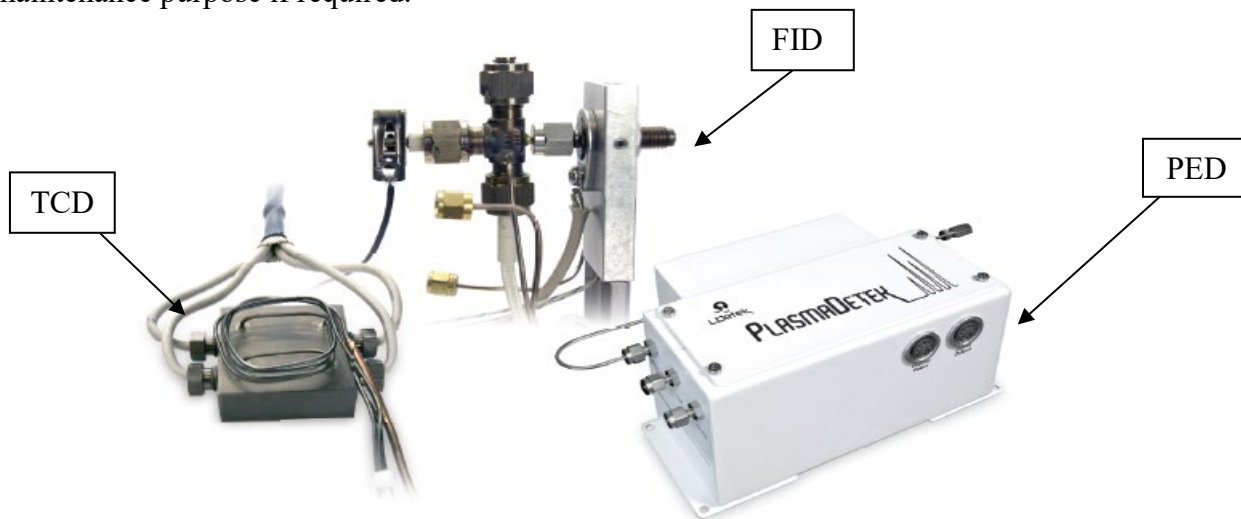

Figure 10 : Type of Detectors

6.2 Motherboard

This I/O board controls all components inside the analyzer (flow, detectors acquisition, temperatures, etc.). When replacing this motherboard be sure to avoid any electrostatic contact.

The Board conception is modular, so it facilitate the replacement of parts on site. The flow sensor for carrier and sample can easily be replaced on site. Such replacement is necessary in case of high contamination of the instrument.

Also, the 4-20mA analog output modules can be replaced on site. There is one module for every impurity (max 10). The microcontroller is also modular and can be easily changed on site. This modular conception of the motherboard has been developed to allow easy maintenance on the instrument and no need to change complete module or returning the instrument to the factory.

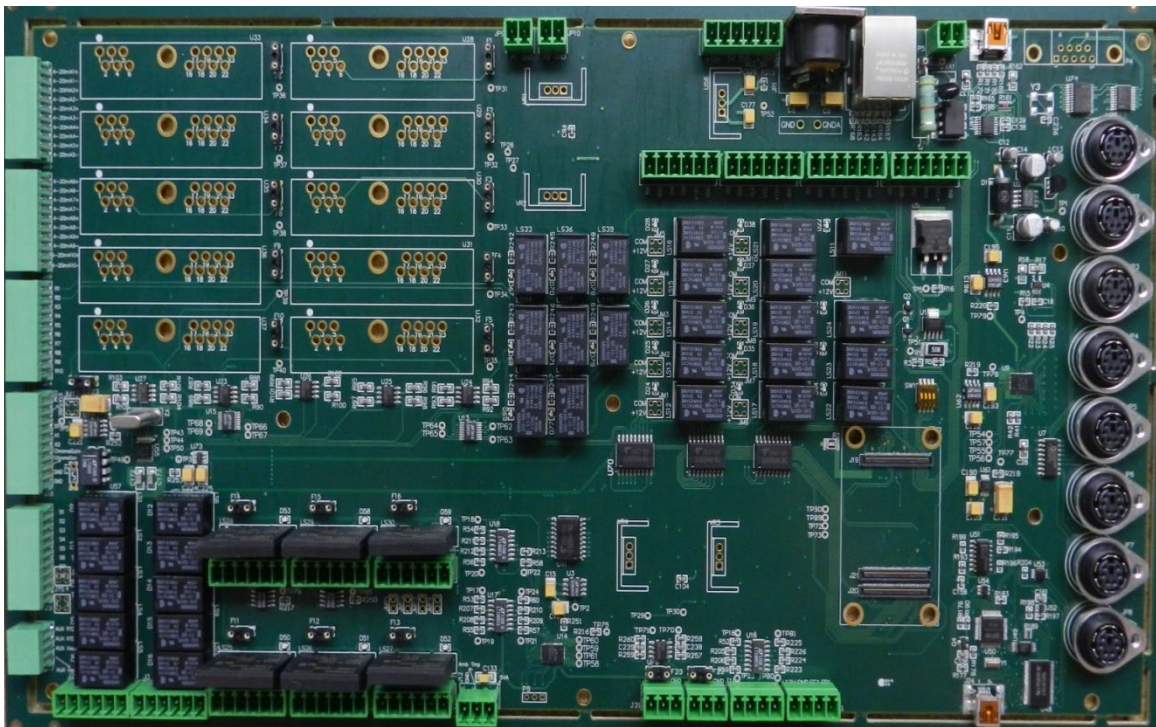

Figure 11 : MultiDetek 2 printed circuit board (PCB)

6.3 Sample gas proportional valve, mini pump or septum injector

This valve is used to control the sample flow inside the instrument. This is a very low dead volume valve that allows minimal purging time at start-up and very quick for flow stabilization. This valve has been designed by LDetek in order to achieve good stability and the possibility of working at ppb level without contamination. This valve can be ordered as spare parts and can easily be replaced on site in the instrument.

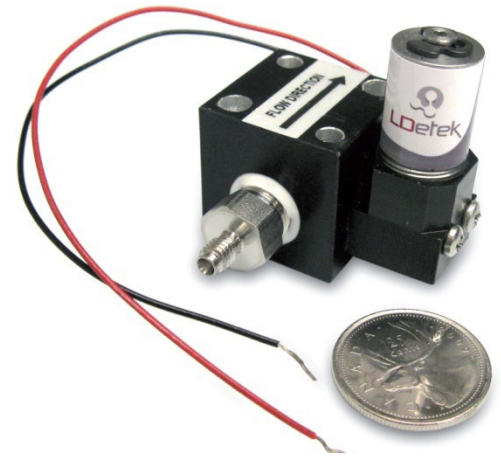

Figure 12 : Solenoid proportional valve

For some applications where sample gas is at ambient pressure or have limited volume, a mini pump can be mounted to suck the sample gas to fill the sampling loop. An intelligent system can also be integrated to suck a precise gas volume to fill the loop with the exact volume. Please contact LDetek for more information.

A split/splitless septum injector can also be mounted for syringe injection. It can also be heated.

6.4 Diaphragm valve and purged/heated valve box

LDetek has worked in collaboration with its valve suppliers to get the right diaphragm valves to offer extended lifetime and high performances. Many methods have been developed and tested to allow high purity measurement without having cross port or outboard contaminations. Valves for aggressive gases are also available with different coating materials. All the valves installed in the MultiDetek 2 and the maintenance of it can be done on site. LDetek requires valve maintenance every 3-5 years depending of the applications.



Figure 13 : Diaphragm valve

For some applications with condensable gases, the valves can be mounted in a heated box contained by the MultiDetek 2 chassis. That heated box can also be purged with inert gas when hazardous or toxic gases are present. Please contact LDetek for more information.

6.5 Carrier gas electronic pressure regulator (LDepec)

The carrier gas flow control in the MultiDetek 2 is managed by a high purity LDeTek electronic pressure controller (EPC). The carrier flow control can be mounted inline or in bypass mode depending on the application.

A manual version of high purity pressure regulator is also available in the MultiDetek 2. Both version are available and can be easily replaced because of their modular designs.



Figure 14 : LDepec

6.6 Ovens and columns

The MultiDetek 2 can have up to 6 isothermal ovens mounted with an easy access by the front door for changing the columns in it. Each oven can fit up to 2 x packed or micro packed or PLOT type columns. The columns can be 1/8'' OD, 1/16'' or PLOT type. The maximum operating temperature of each oven is 200 Celsius degree. A safety temperature cut off switch protection is installed in each oven to avoid overheating of each device.

A programmable oven version is also available in the MultiDetek2. It is the same internal dimension of the isothermal version and can then offer the same columns configuration in it. The MultiDetek 2 platform can accept up to 3 programmable ovens or a combination of isothermal ovens and programmable ovens. It offers a lot of flexibility.



Figure 15 : Isothermal and programmable oven

6.7 Large 8.4" touch screen LCD & LDChroma

The MultiDetek 2 offers an easy and complete interface working on Windows 7 embedded. With its clear 8.4" touch screen LCD, it allows the operator to easily navigate through the different menus. Moreover, the system includes an Ethernet port for remote control.



Figure 16 : 8.4" Touch screen LCD

6.8 Built-in sample purging and monitoring system

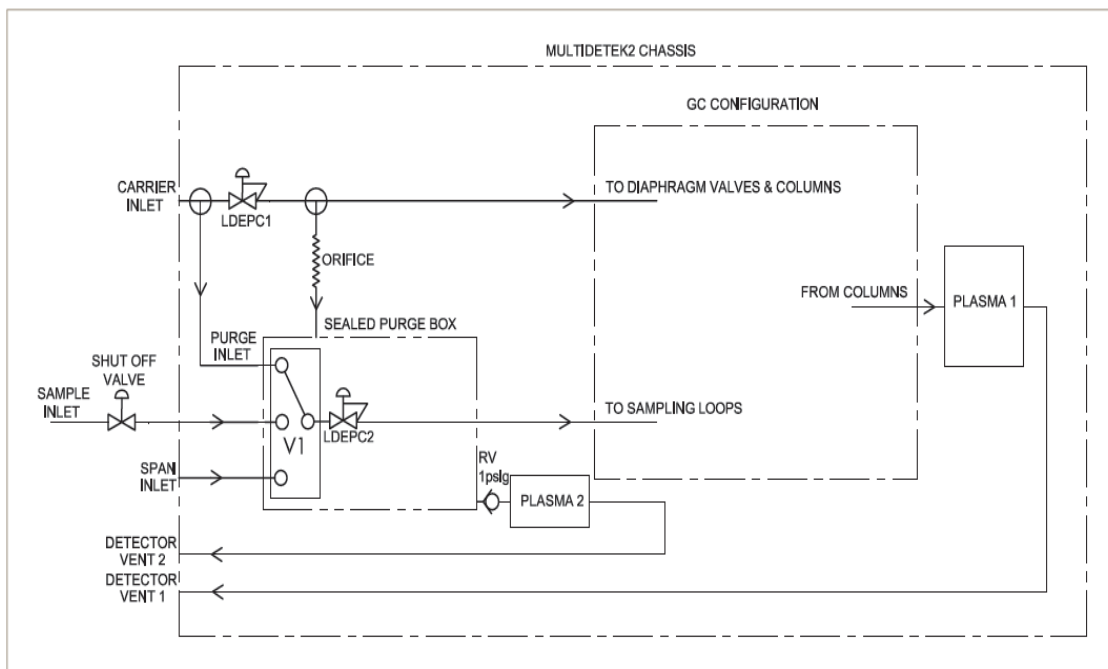

Figure 17: Built-in sample purging and monitoring system

Handling highly flammable gas like silane or any other hazardous or explosive gases requires a high level of safety and it is what LDETEK offers with its built-in sample purging and monitoring system inside the MultiDetek 2 compact GC. This system consists of 4 steps of safety:

Step 1: The sample gas flow path external to the purged box is fully welded offering no possibility of leakage.

Step 2: A selection valve (V1) is mounted before the diaphragm valves used for filling the sampling loops in the system. That selection valve (V1) is configured to allow the hazardous gas going to the sampling loops only for a predetermined period of time just before to start each analysis. The short period of time is configured in factory and is dependant to the system configuration. The rest of the time, the selection valve (V1) is switched on a purged gas which is normally the same gas type that the carrier gas of the system for purging the sampling loops. In the eventuality of leakage on the sampling loops or on the injection diaphragm valves, the reduced period of time introducing silane in the injection valves combined with the low pressure operation and small volume will avoid any potential hazardous situation.

Step 3: A sealed purge box containing the sample flow electronic pressure controller (LDEPC2) and the diaphragm selection valve (V1) is mounted in the MultiDetek 2 chassis. That box is normally purged with the same gas type that the carrier gas used for the system. That environment requires low purge flow rate of about 10-30sccm through a fix orifice depending of the system configuration. The box is fully ambient air free and the system is ready to use after a short period of about 20-30 minutes depending of the system configuration. This waiting period is only requires for initial start-up since once the MultiDetek 2 has carrier flow going in it, the box is continuously on purge. Having a box fully purged with UHP carrier gas eliminates the ignition risk in potential presence of silane or any other explosive gases. A 1psig relief valve (RV) is mounted on the box to build up a minimum sealing pressure and to maintain a constant purge with the carrier gas.

Step 4 (optional): The sealed purge box could be continuously monitored using a micro PED (PLASMA2) to selectively measure trace N₂ to ensure there is no air contamination in the sealed box to avoid the ignition in potential presence of hazardous gas. If trace of air is measured in the purged box by the micro PED (PLASMA2), then an alarm is activated to shut off the flow of hazardous gas inside the MultiDetek 2. The shut off valve must be mounted external to the MultiDetek 2 chassis. The feedback signal controlling the shut off valve comes from the MultiDetek 2. It is requires to maintain the sample gas pressure coming to the shut off valve below 10psig to minimize the risk of ignition. The flow type selected by the selection valve (V1) is controlled with the electronic flow controller (LDEPC2) to ensure a stable and constant flow rate whichever the gas type selected.

6.9 Bolt on compact purifier

A compact purifier can be bolt on the MultiDetek 2 back panel. It offers the same performances than standard large gas purifier in a compact design. The maintenance is easy since the compact unit is mounted on the back panel of the MultiDetek 2 and it is easy to have access from the back side. The unit offers intelligence and the LED diagnostic system will turn red when the unit must be replaced. In normal operation, the lifetime is in average 2-3 years depending on the application.



Figure 18: Compact LDP-1000

6.10 Advanced Quartz Crystal Microbalance sensor

The Advanced Quartz Crystal Microbalance sensor from Michell Instruments is now integrated inside the MultiDetek2 GC to provide reliable, fast and accurate measurement of trace moisture content in a variety of applications where keeping moisture to a minimum is of critical importance. The analyzer provides consistently accurate measurements of trace moisture. This consistency is achieved using a self-calibration system, which adjusts the sensor with reference to an internal moisture generator. The moisture generator is supplied with a calibration traceable to NPL and NIST, so long term stability of its measurements is guaranteed. Having such module inside a GC allows to combine multiple impurities analysis with trace moisture inside the same instrument.

7. LDChroma

The MultiDetek 2 has a dual-core microcontroller (one core is a DSP for digital signal processing) that communicate with an 8-inch panel PC (touch screen). It offers an easy and complete interface named LDChroma working on Windows 7 embedded. You can use the USB connector on the front panel to connect a keyboard. The touchscreen must be handled carefully to avoid any problem with the sensitivity.

The following section shows the different tabs and menus on the interface.

7.1 Configuration

The configuration tab show different menus describe below.

7.1.1 Machine

The Machine menu allows you to import or export all the settings of your GC in a machine file (.md2m). The file contains all the settings and the historic and can be open with LDChroma on another computer. It is useful for diagnostic or backup purpose.

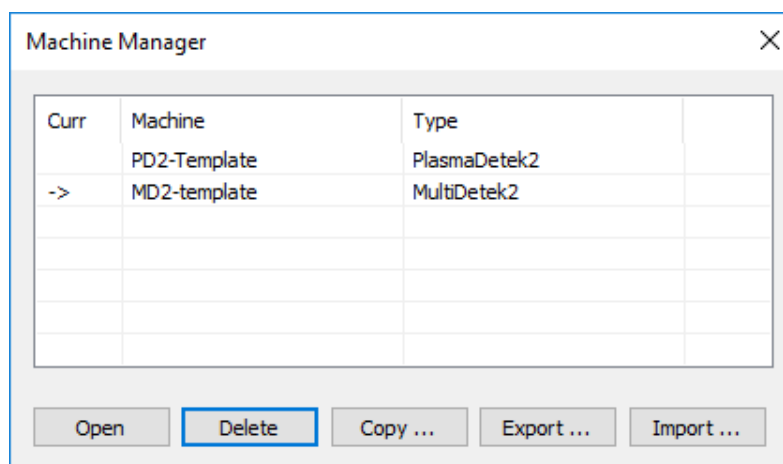

Figure 19: Machine Manager

7.1.2 Method

The Method menu allow you to manage all the methods you have on you GC.

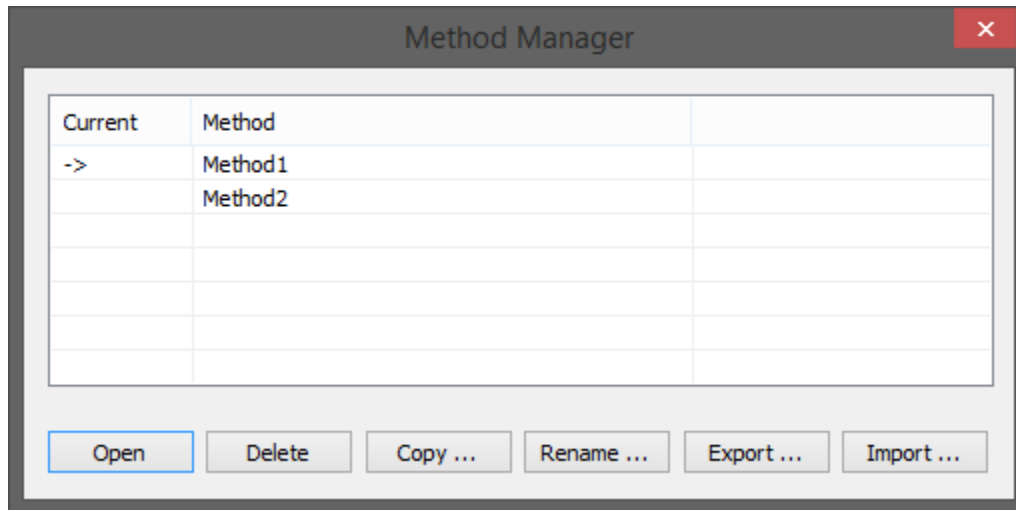

Figure 20: Method Manager

Open: Allows you to open the selected method.

Delete: Allows you to delete the selected method.

Copy: Allows you to copy the selected method.

Rename: Allows you to rename the selected method.

Export: Allows you to export the selected method into a method file (.md2c).

Import: Allows you to import a method file (.md2c)

7.1.3 Factory

The Factory menu is used to come back to the factory settings.

7.1.4 Network

The Network menu is used to show the current network settings.

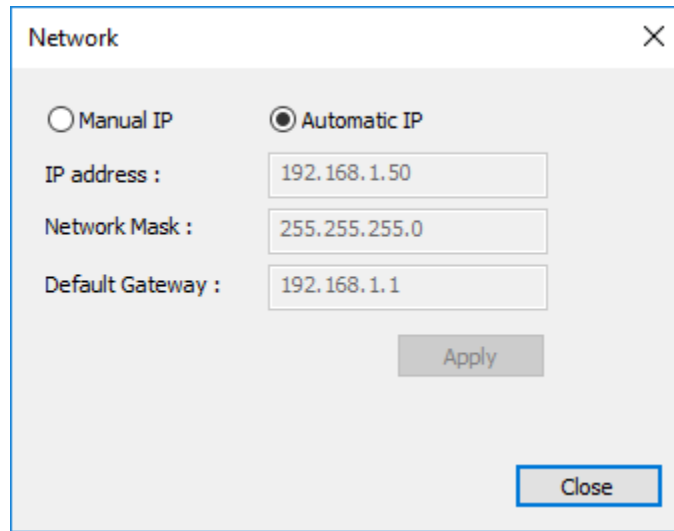

Figure 21: Network

7.1.5 User and Admin Mode

User Mode: While in this mode, the user has limited access to settings

Admin Mode: While in this mode, the user has access to all the settings. The factory password to access this mode “12345”. It can be change in the setting menu (see section 6.3.1.8).

7.2 Chromatogram tab

7.2.1 Chromatogram

The Chromatogram menu is where you run the analysis. It is where you can see the chromatogram, the current results, the alerts, the oven temperature, the sample flow and the carrier flow.

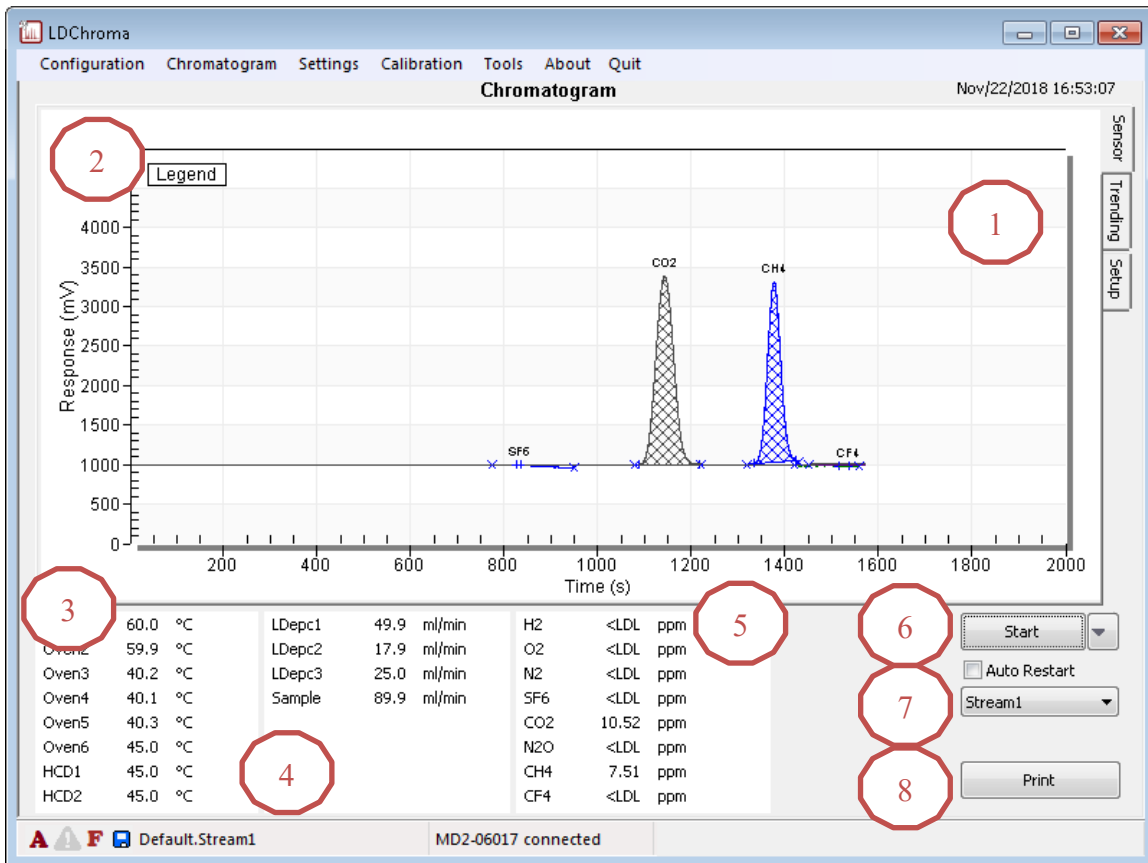

Figure 22: Chromatogram menu

- 1- On the chromatogram, the X-axis shows the time in second and Y-axis shows the voltage in mV.

- 2- To see the voltage of each sensor you must click on "Legend" in the top left corner of the chart. By moving the mouse arrow in the chart, you will see the mV in the legend for each sensor.

Legend	
<input type="checkbox"/> Time	214.7s
<input checked="" type="checkbox"/> Sensor1	1000.00
<input type="checkbox"/> Sensor1(raw)	578.58
<input checked="" type="checkbox"/> Sensor2	1000.00
<input type="checkbox"/> Sensor2(raw)	6489.83
<input checked="" type="checkbox"/> Sensor3	1000.00
<input type="checkbox"/> Sensor3(raw)	233.16

Figure 23 : Solenoid proportional valve

- 3- The oven temperatures are displayed in the bottom left of the screen.
- 4- The carrier and sample flow are displayed next to the oven temperature.
- 5- The last field is used to display the results of the current analysis.
- 6- The "Start" button will start an analysis if pressed. When a cycle is running, the button will show "Stop". By pressing the stop button, the analysis will end.

The "Auto Restart" checkbox is used to restart automatically an analysis or a sequence.

The arrow beside of "Start" is used to select different methods or sequences. Only one can be selected at a time.

- 7- This field appear if streams are configured. By clicking on the arrow, you are able to select the stream you want to analyse.
- 8- The button "Print" is used to print the current cycle data to your printer. The printer drivers have to be installed prior.

7.2.2 Bottom bar

The bottom bar is split in 3 and contains the main information about the GC.

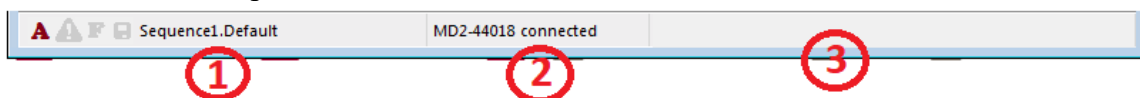

Figure 24: Bottom bar

7.2.2.1 Left bottom bar

At the left, 4 icons are displayed. If the "A" is red, it means that the system is in admin mode. If that is the "U" that is red, it means that the system is in user mode.

The second icon is an exclamation mark. If this icon is coloured, it tells you that your current settings are different than the ones in the GC, you will need to download the settings to the DSP prior to start an analysis.

The third icon is an “F”. If this icon is coloured, it tells you that one or more output(s) are forced in the GC. For instance, the outputs of the MultiDetek2 may have been forced for diagnostic purpose. This icon is there to remind the user that one or many I/O are forced.

The last icon is a floppy drive. If it is coloured, it tells the user that some changes were made but they are not saved to the disk yet.

Beside the icons, you have the current sequence and method name.

If you right-click on this part of the bottom bar, you will see the menu shown in the following picture.

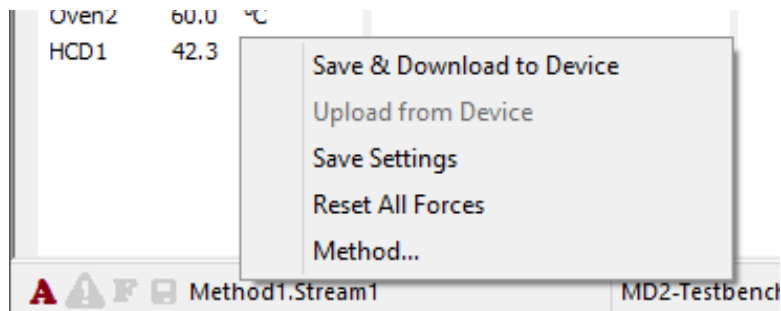

Figure 25: Left bottom bar

Save & Download to Device: Save all the settings on the disk and download them to the GC.

Upload from Device: Take all the settings in the GC and upload them. **WARNING** The GC does not contain all information like description text. So uploading should only be used when you have no other choice.

Save Settings: Save all the settings on the disk.

Reset All Forces: Reset the output(s) that are forced in the GC.

Method: To open the method manager.

7.2.2.2 Middle bottom bar

The middle part of the bottom bar is the “device status” part. When the communication between the panel PC and the motherboard is good, it is displayed “MD2-XXXX connected”

If there is no communication between the pane PC and the motherboard, it is displayed MD2-XXXX not connected.

When running an analysis, it is displayed the progression and the cycle time. For instance, the picture below shows that the cycle time is 300 sec and the cycle started 68 sec ago.

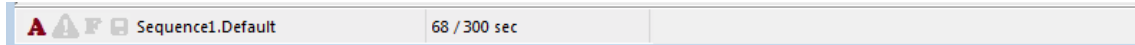

Figure 26: Middle bottom bar

7.2.2.3 Right bottom bar

The right bottom bar display information about the alert. When the bar becomes red, it means that there is one or more active alert(s). The bar can also become yellow. In that case, it means that there is a warning. Otherwise, if gray, there is no alert and the MultiDetek2 is ready to perform an analysis. By double-clicking on the bar, the following window will appear.

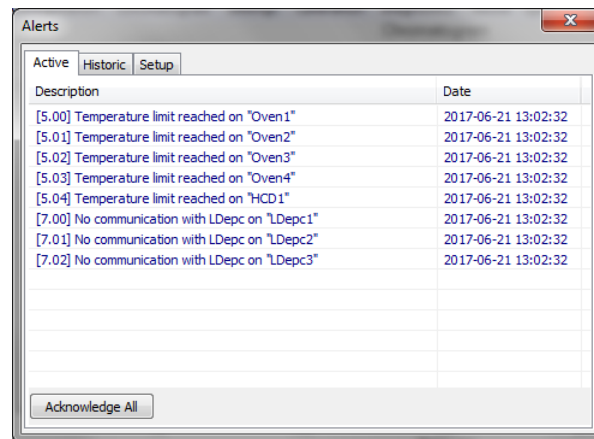

Figure 27 : Alerts windows

Active tab: It lists all the active alert. If the alerts are red, they are active, if they are blue they are active but they have been acknowledged. There is a button to acknowledge all the active alerts in the bottom.

Historic tab: It contains a history of all the last activated alerts.

Setup tab: It contains all the known alerts. At this place, you can find all important information about them.

7.2.3 Historic

This menu is used to consult the previous analysis results.

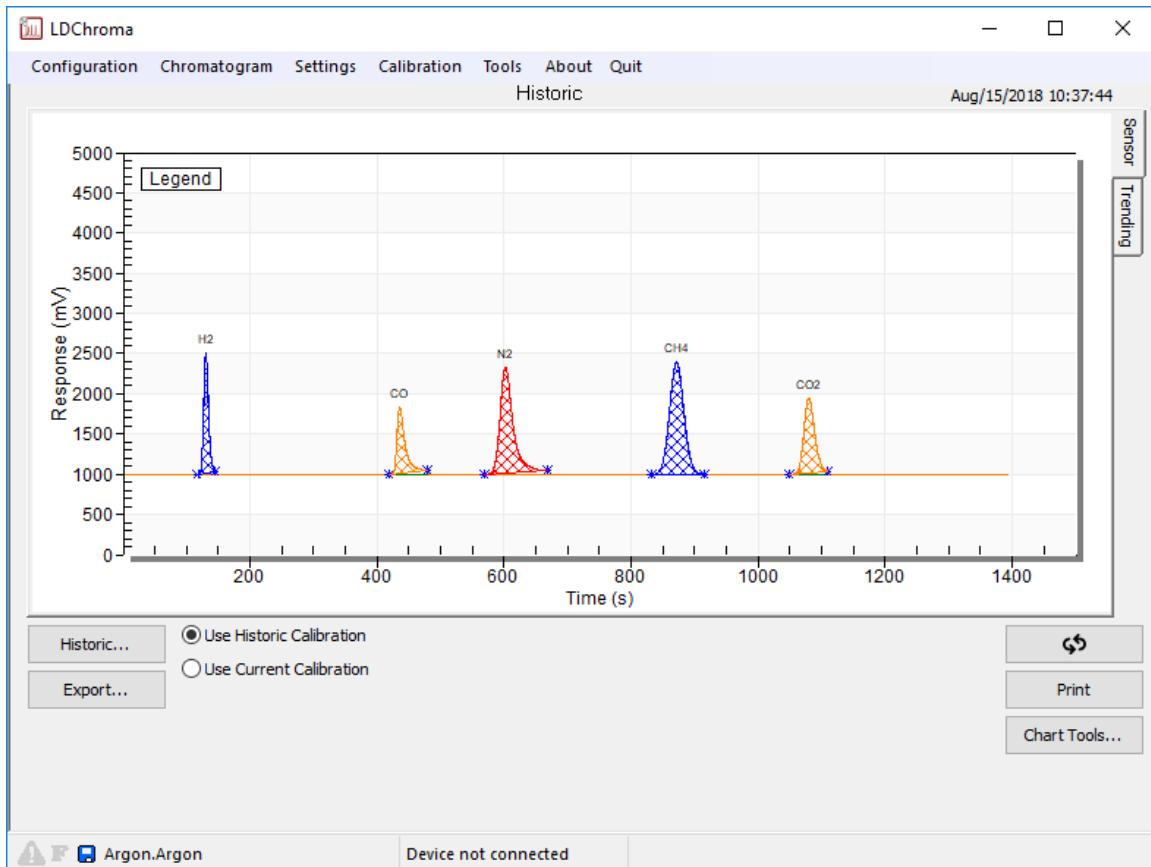
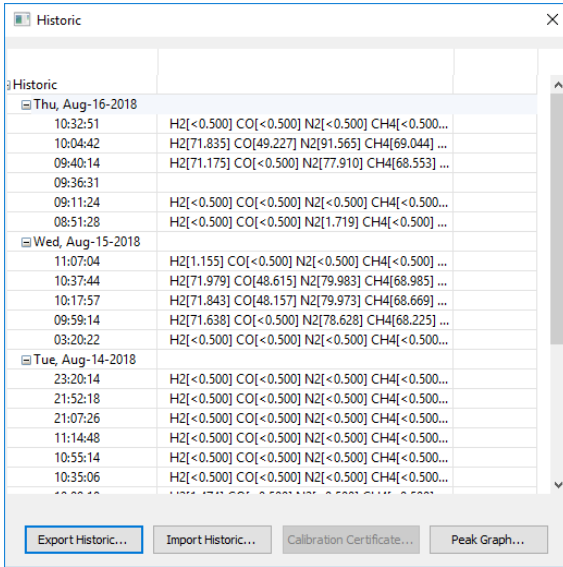

Figure 28 : Historic menu

Export: allows you to export the current chart under the Excel format.

Print: The “Print” button allows you to print the current chart.



If you click the “Historic...” button, you will see the list of the last analysis results:

If you select a result in the list, the chart will change to this analysis.

The export button saves the selected historic on any drive you want.

The import button loads the historic saved on a hard drive.

The Peak Graph button shows graphically the concentration of all gases for a period of time.

Figure 29 : Historic list window

			Area	Retenti...	Height	Sensor Avg.	Sensor No	Peak Noise
H2	71.979	ppb	13215	130.2	1496.214	0.000	0.000	0.017
CO	48.615	ppb	11992	435.6	819.367	0.000	0.000	0.039
N2	79.983	ppb	30956	602.0	1318.321	0.000	0.000	0.014
CH4	68.985	ppb	36798	871.4	1395.022	0.000	0.000	0.017
CO2	63.413	ppb	18190	1079.5	926.412	0.000	0.000	0.039

If you double-click on a result, a new window will show up with more information such as concentration, area, retention time, height and noise.

Figure 30: Peak Results

If you double-click on a peak, you will see the settings used for the peak detection algorithm.

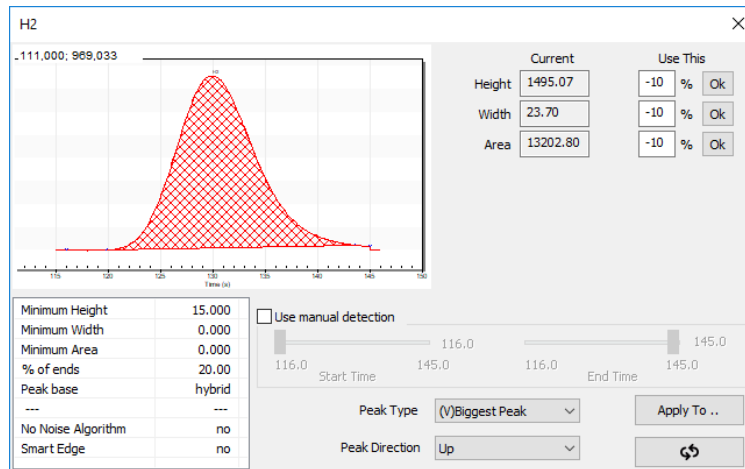

Figure 31: Peak detection menu

7.3 Settings Menu

7.3.1 Setting

In this menu, there are all the parameters of the MultiDetek2. **These parameters should not be changed without contacting LDetek support.** The available settings may vary depending on the software version. To update the software, **please contact LDetek support to ensure the versions are compatible with your system.**

The settings are split into 2 categories. The first one is named “Method”. It is where the settings relative to the current method are configured. Parameters such as valve timing, ovens temperatures and flows setpoint are defined in that section. If the system has more than one method, it is required to change the method to access the others methods settings.

The second category is named “Machine”. It is where the settings regarding the Multitetek2 are configured. Parameters such as streams, sequences and 4-20mA module are defined in that section.

7.3.1.1 Misc

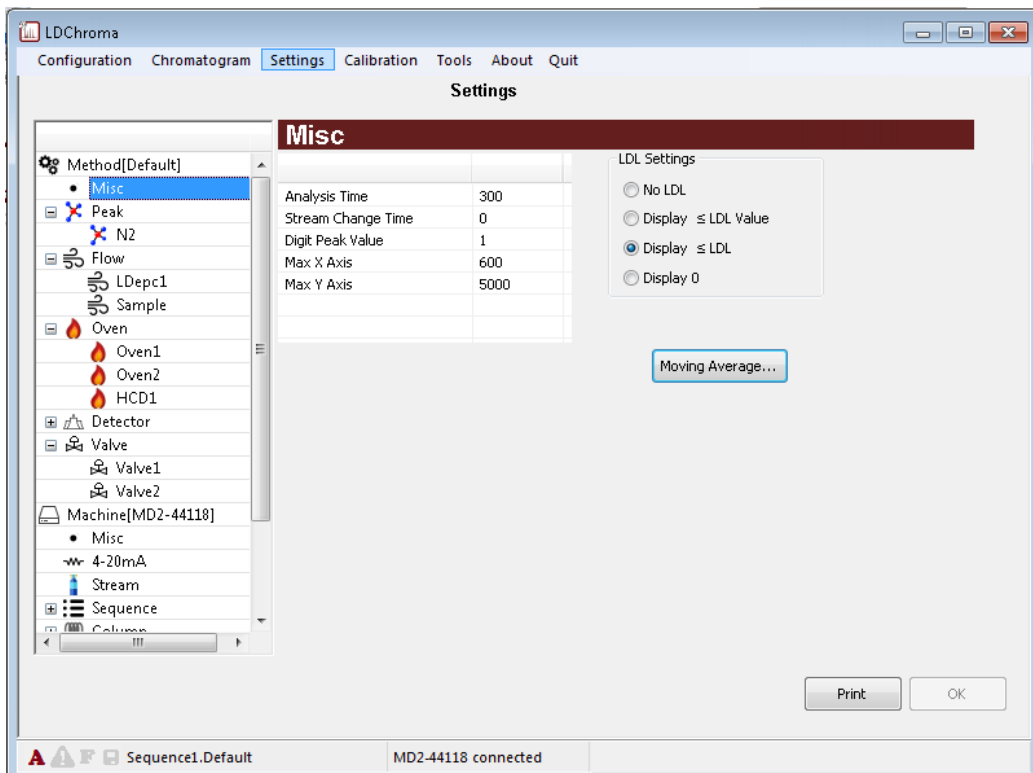

Figure 32 : Settings menu

- Analysis Time:** The cycle time of the current method
- Stream Change Time:** It is the time where it is possible to change the current stream without affecting this analysis. This parameter is used only when running a sequence and if the next analysis in the sequence has a different stream. When the value is 0, the stream will never change during this analysis
- Digit Peak Value:** The number of digits displayed in the results (resolution)
- Max X Axis:** The maximum value of the X axis
- Max Y Axis:** The maximum value of the Y axis
- LDL Settings:** To change the way the results are displayed when the reading is below LDL

7.3.1.2 Peak

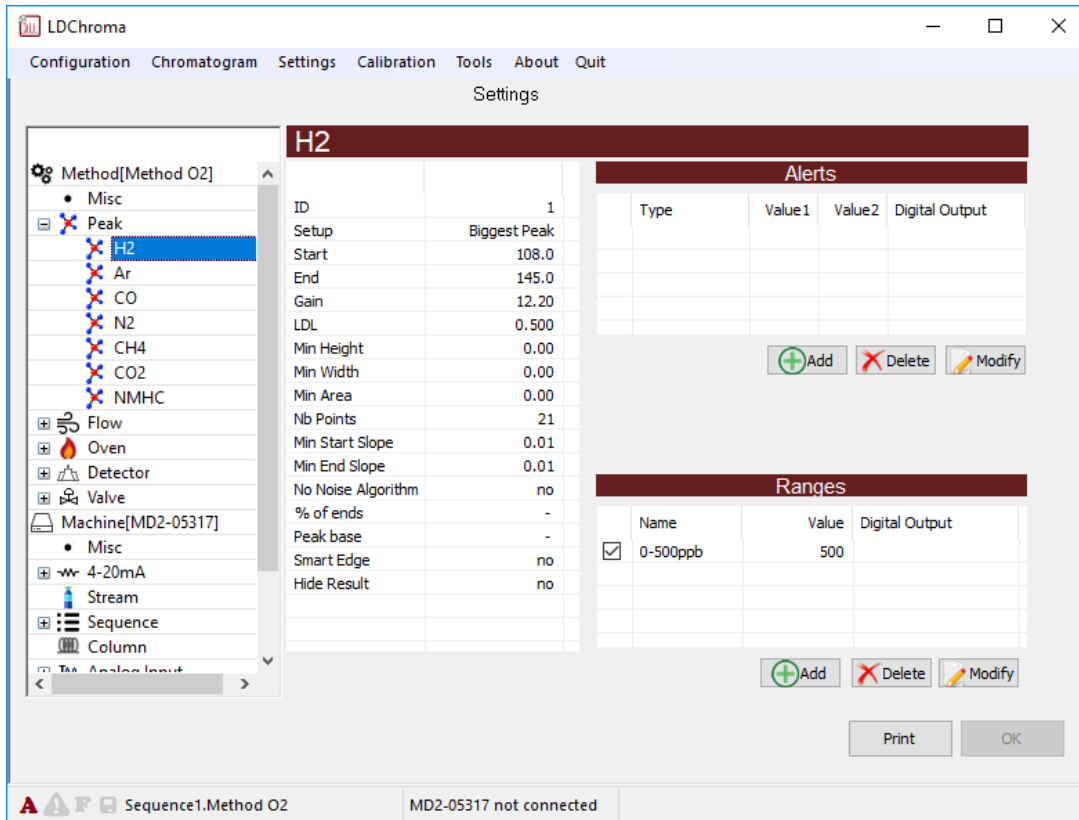

Figure 33: Peak setting menu

- Setup:** The peak detection algorithm can be changed by double-clicking on setup
- Start:** The start time of the current peak
- End:** The stop time of the current peak
- Gain:** The gain of the current peak
- LDL:** The lowest detectable limit (LDL). Any result with a concentration lower than this value will be considered as LDL.
- Alert:** It is where you can define different alert level for each peak
- Ranges:** The ranges are used for the 4-20mA scale ; 0 “unit” (ppb, ppm or %) = 4mA Range Value = 20mA

The parameters below “LDL”, may vary depending on the peak detection algorithm used. The detection algorithms are described below.

There are 7 types of detection for a peak.

- Biggest Peak:** In the peak window, the algorithm will detect every rise and every drop. A rise followed by a drop is considered as a peak. In the Biggest Peak mode, the biggest peak detected in the window will be kept.
- Multi Peak:** In the peak window, the algorithm will detect every rise and every drop. A rise followed by a drop is considered as a peak. In the Multi Peak mode, the first rise and the last drop is considered as the peak.
- Bypass detection:** In this mode, we compute the area of everything upward the start and the end of the window.
- FWHM:** This is a mode currently in development.
- Averaging:** Instead of computing an area, this mode makes an average of the reading during the window.
- Follower:** Same as “Averaging” except that the 4-20mA is continuously refresh.
- (V)Biggest Peak:** Same as “Biggest Peak” except that the detection is made by using vector.

7.3.1.3 Flow

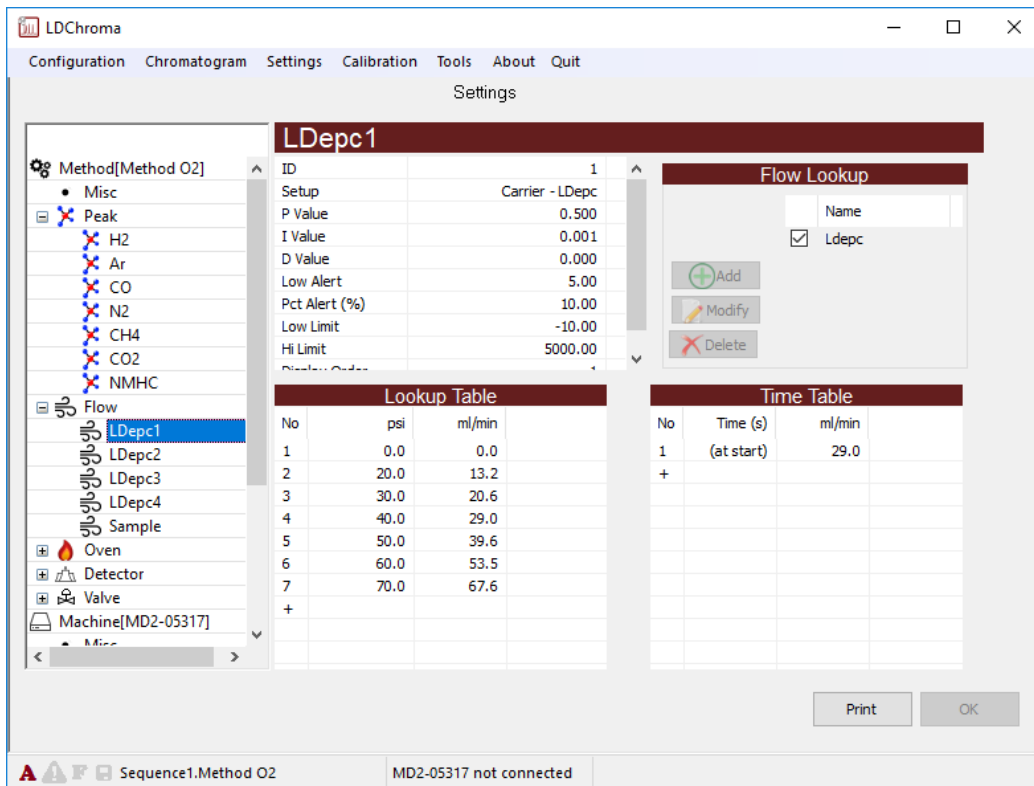

Figure 34: Flow setting menu

Setup:

By double-clicking on it you can change:

- The name of the flow
- The type of flow
 - Sample
 - Carrier
- The flow control type
 - Automatic (closed-loop control)
 - Manual (just for reading, no output)
 - LDepc (extern control)
- Input / Output used for the control

P Value:

Proportional gain for the closed-loop control

I Value:

Integral gain for the closed-loop control

D Value:

Derivate gain for the closed-loop control

Low Alert:

Below this value, the Low Flow alert will turn ON

Pct Alert:	The percentage of deviation allowed before the flow deviation alert
Low Limit:	The lowest value to be considered as a normal condition. If we have reading lower than that, the system will stop trying to control it. Because there is probably something wrong, a broken sensor for instance.
Hi Limit:	The highest value to be considered as a normal condition. If we have reading higher than that, the system will stop trying to control it. Because there is probably something wrong, a broken cable for instance.
Lookup Table:	This is the table to convert the sensor reading into units
Time Table:	It contains the setpoint for the flow. The “(at start)” is the setpoint to reach when no analysis is running. In other words, before an analysis start. You can add more setpoint at different time in an analysis.
Flow LookUp:	This is where you can select a LookUp table from the list. This is normally used when different balance gases are used as sample gas.

7.3.1.4 Oven

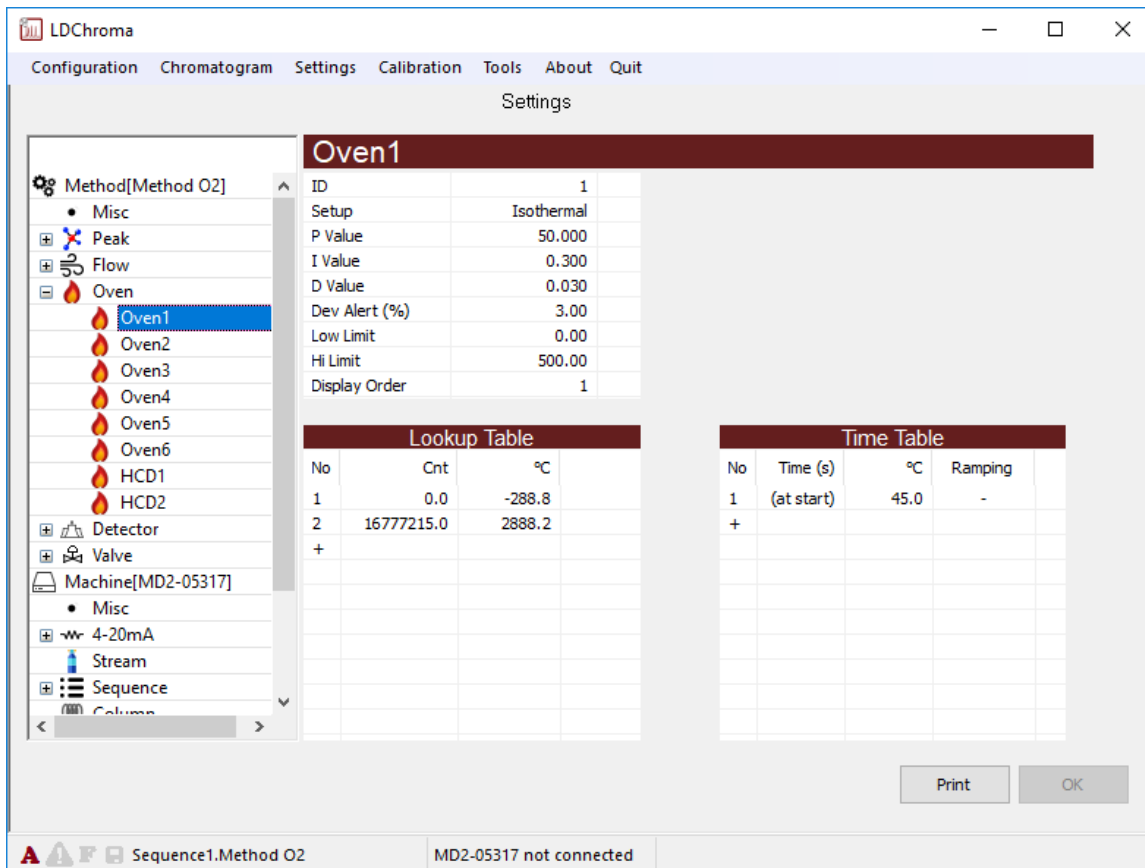

Figure 35: Oven setting menu

Setup:

By double-clicking on it you can change:

- The name of the oven
- T° sensor you want to use for this oven
- The type of oven
 - On/Off (isothermal oven)
 - On/Off+fan (programmed ramping oven)
 - Proportional (HCD)
- Input / Output needed for the control

P Value:

Proportional gain for the closed-loop control

I Value:

Integral gain for the closed-loop control

D Value:

Derivate gain for the closed-loop control

Dev Alert:	The percentage of deviation allowed before the oven temperature deviation alert
Low Limit:	The lowest value to be considered as a normal condition. If we have reading lower than that, the system will stop trying to control it. Because there is probably something wrong, a broken sensor for instance.
Hi Limit:	The highest value to be considered as a normal condition. If we have reading higher than that, the system will stop trying to control it. Because there is probably something wrong, a broken cable for instance.
Lookup Table:	This is the table to convert the sensor reading into units
Time Table:	This table contains the setpoint for the oven. The “(at start)” is the setpoint to reach when no analysis is running. In other words, before an analysis start. Then you can add more setpoint at for different time in an analysis.

7.3.1.5 Detector

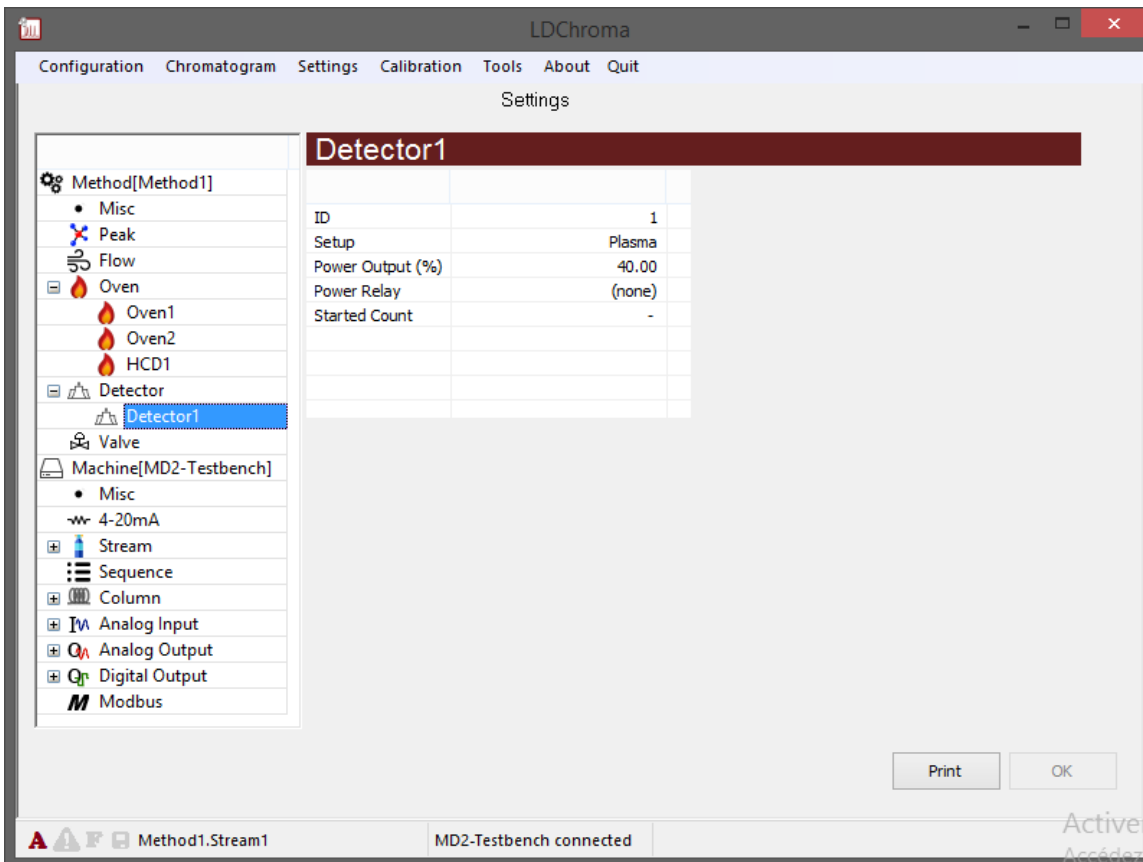

Figure 36: Detector setting menu

Setup:

By double-clicking on it you can change:

- The name of the detector
- The type
 - Plasma
 - TCD
- Input / Output needed for the control and monitoring

Power:

The value in % for the power delivered to the detector

Power Relay:

Selection of a relay to cut power to detector. Only used for TCD detector.

Started Count:

The number of counts where the detector is considered ON

7.3.1.6 Sensor

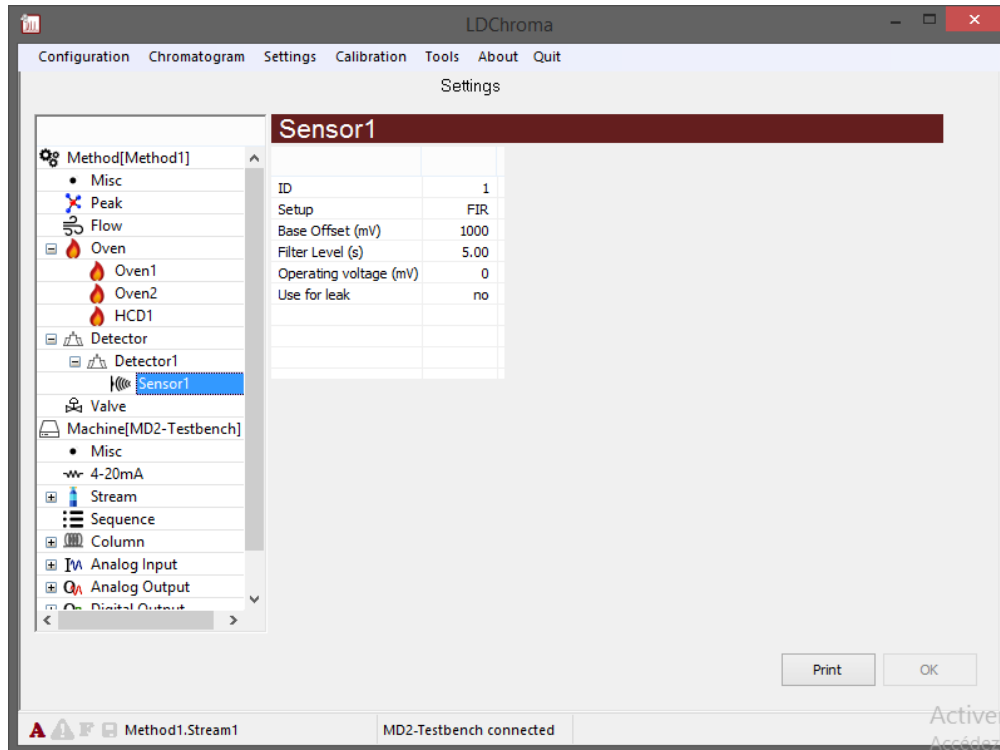

Figure 37: Sensor setting menu

Setup: By double-clicking on it you can change:

- The name of the sensor
- The color on the chart
- The type of filter
 - Average
 - Median
 - FIR
 - Curve Fitting

Base Offset: If you enter 0, this parameter has no effect. If you put any other value, outside a peak window the filtered value of this sensor will be set at this value.

Filter Level: This is a value in second. More second you put, more effective the filter will be. For instance, if you put 10 seconds with an “Average” filter, the filtered value will average 10 seconds of raw data.

Operating Voltage: Factory normal sensor operation voltage

7.3.1.7 Valve

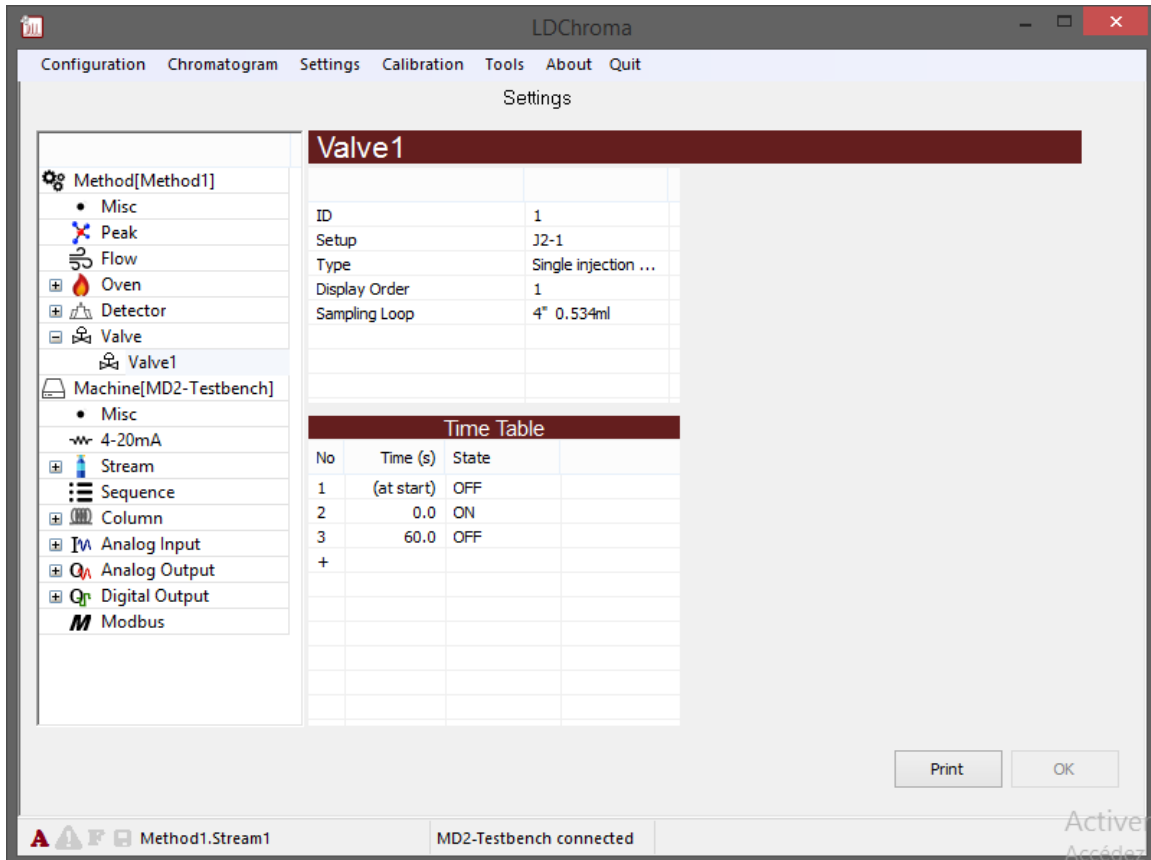

Figure 38: Valve setting menu

- Setup:** By double-clicking on it you can change:
- The name of the valve
 - The digital output associated with it
- Type:** Configuration of the valve (Injection, Heartcut, Backflush, etc.)
- Sampling Loop:** It shows the sampling loop volume if it is a valve that contains sample loop.
- Display Order:** This determine the order the valve will have in the menu.
- Time Table:** The table contains the time where the state of the valve change.

7.3.1.8 Misc

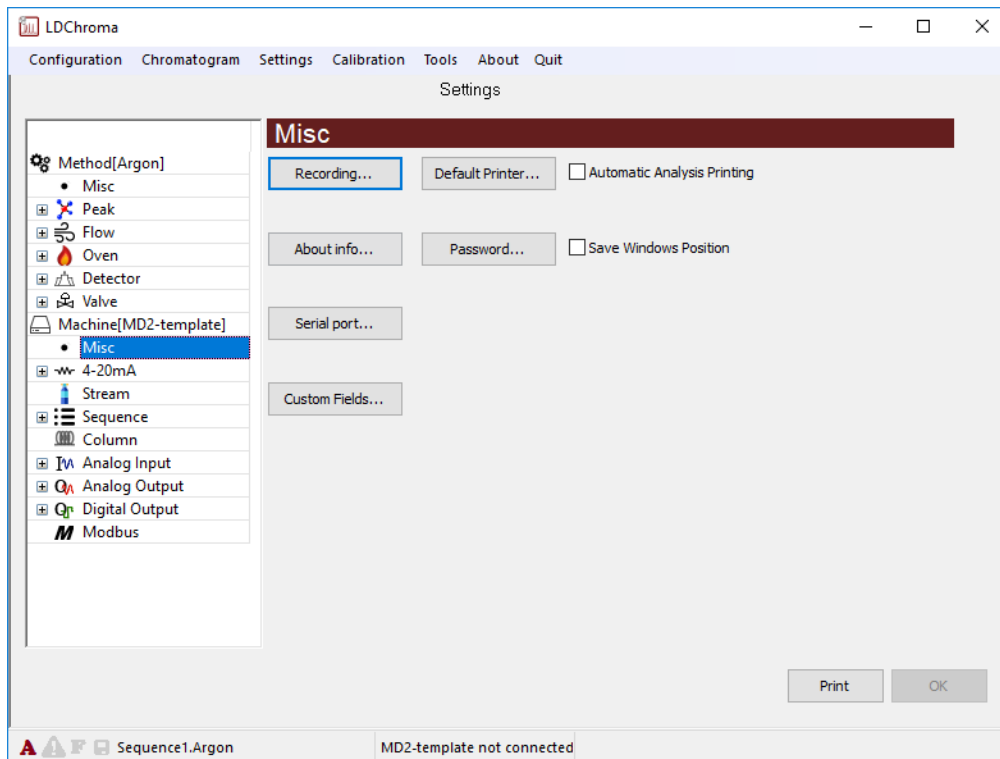

Figure 39: Machine setting menu

- Recording:** To manage the folder or drive where the analysis results are recorded
- About info:** To manage useful information about the MultiDetek2
- Serial port:** To manage the setting related to the serial communication
- Custom Field:** To setup custom field associated with results
- Default Printer:** To select a default printer
- Password:** To manage password for the admin mode
- Automatic Analysis printing:** To activate automatic printing after each analysis
- Save Windows Position:** To activate windows position feature

7.3.1.9 4-20mA

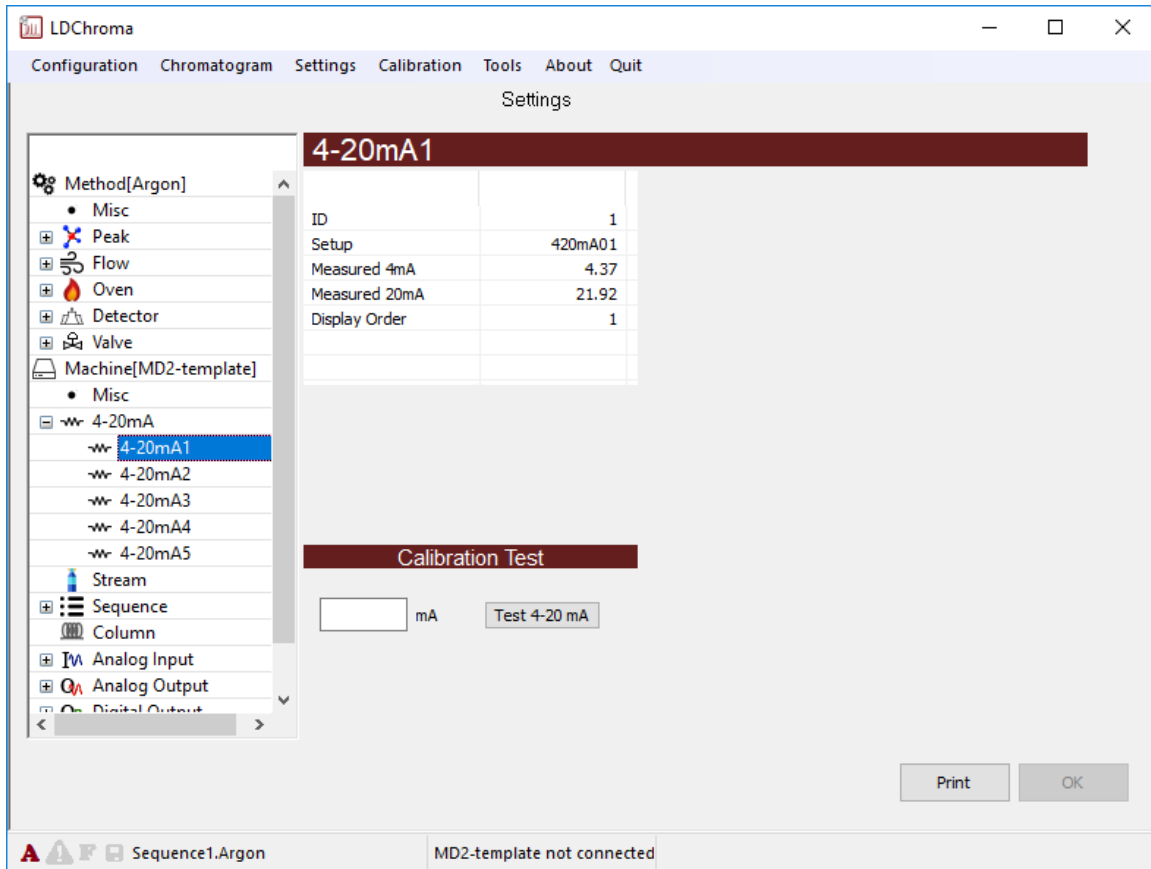

Figure 40: 4-20mA settings menu

Setup: By double-clicking on it you can change:

- The name of the 4-20mA
- The analog output associated with it

Measured 4mA: The current measured during the calibration should be put there. By double clicking on the field, the output will be set to 4mA.

Measured 20mA: The current measured during the calibration should be put there

Calibration Test: To force the selected 4-20mA output at the desired value

Display Order: This determine the order this 4-20ma out will have in the menu.

7.3.1.10 Stream

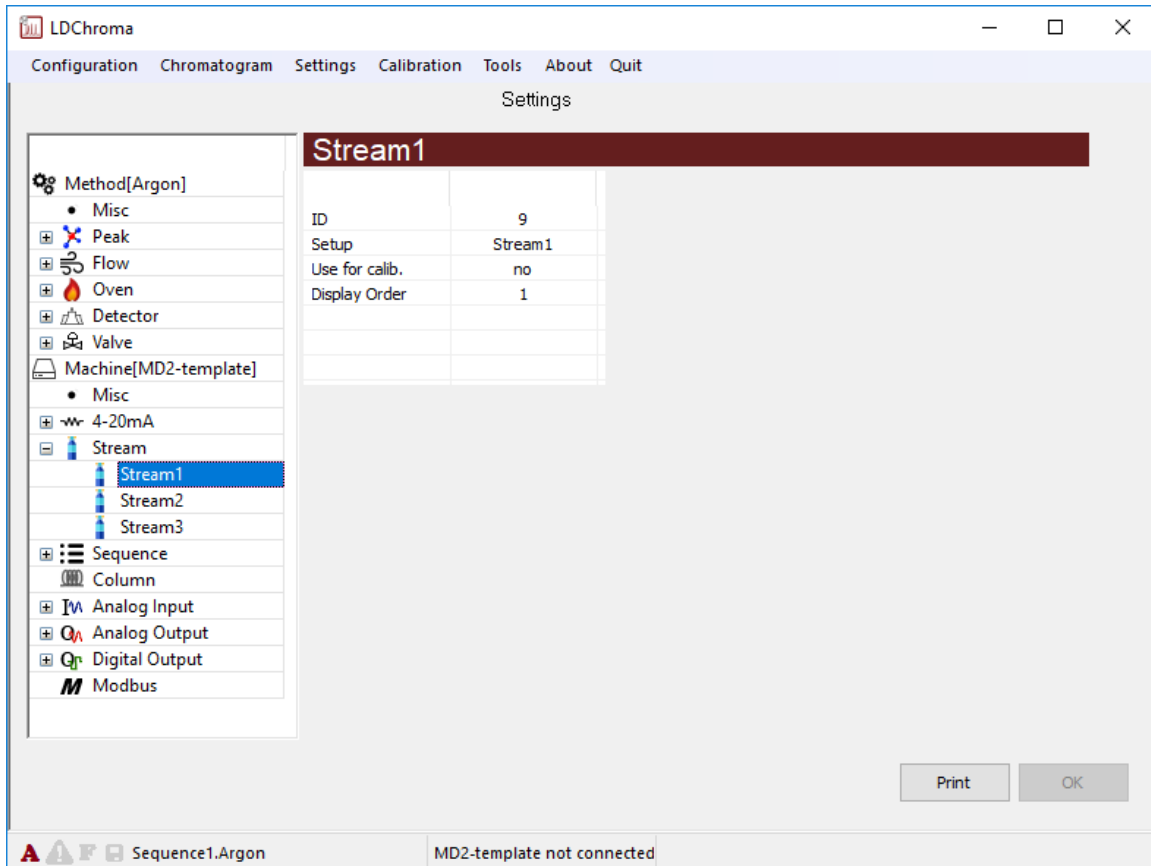

Figure 41: Stream settings menu

Setup: By double-clicking on it you can change:

- The name of the stream
- The digital output associated with it

Use for Calib.: This is used to determine the stream used for calibration of the analyser

Display order: This determine the order this stream will have in the menu.

7.3.1.11 Sequence

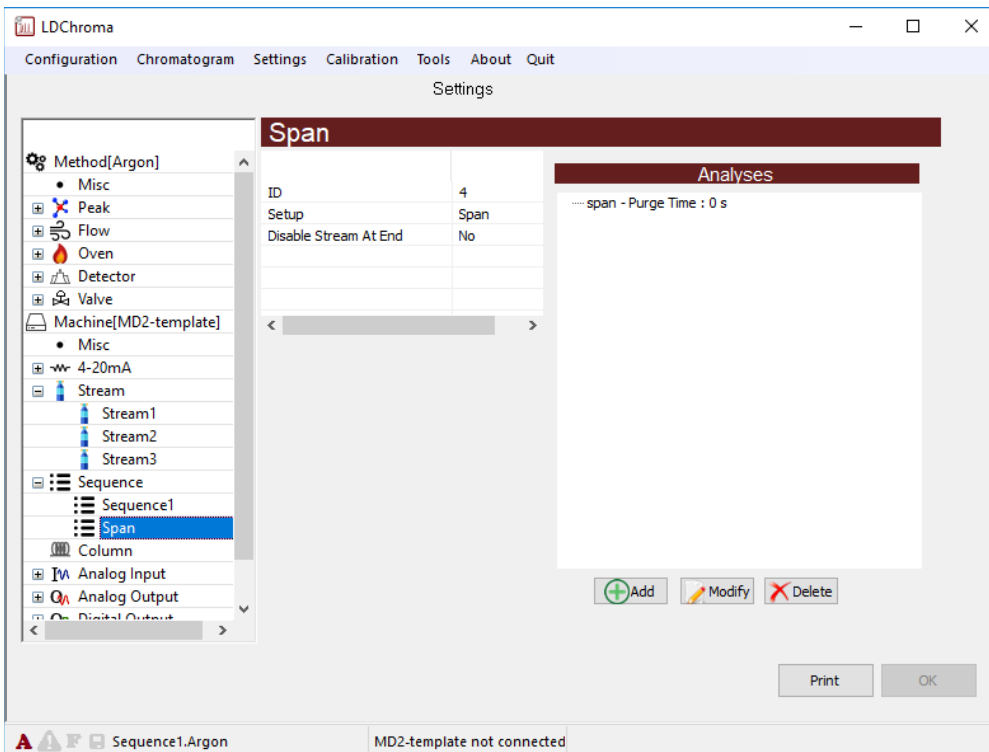

Figure 42: Sequence setting menu

Setup: By double-clicking on it you can change the name of the Sequence

Disable Stream at End If it is enabled, at the end of the sequence, no stream will be selected

Add: To add an analysis to the current sequence

Modify: To modify an analysis in the current sequence

Delete: To delete an analysis in the current sequence

Analysis selection: By double clicking modify on one line in analysis area you can change:

- Method selected for this analysis
- Purge time before to start this analysis
- Stream selected for this analysis

Select between Until analysis end or a pre-set time

7.3.1.12 Column

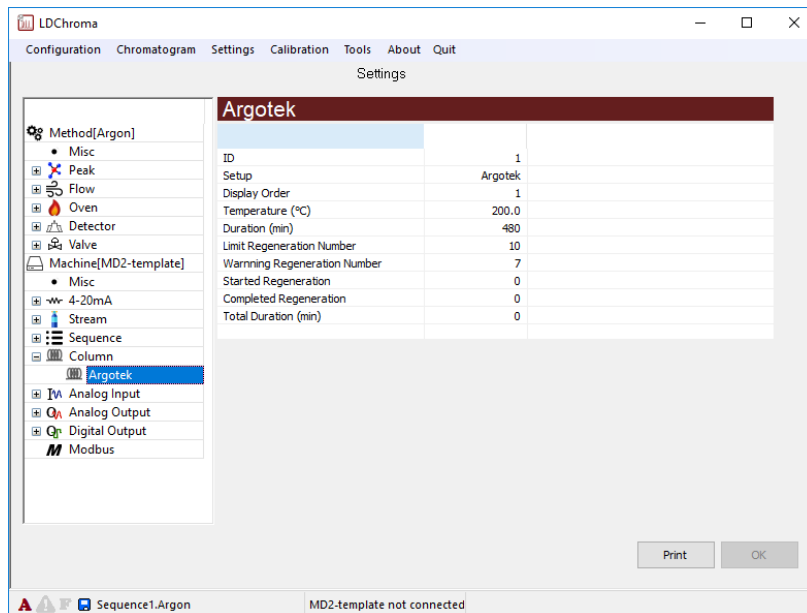

Figure 43: Column setting menu

- Setup:** By double-clicking on it you can change
- the name of the column
 - the oven that contains this particular column
 - the valve(s) and state of it(them) when column regeneration is in process
- Description:** Additional description on the column
- Temperature:** Temperature setpoint of the regeneration
- Duration:** Duration of the regeneration
- Limit Reg. Nb:** Setting for maximum suggested regeneration process
- Warning Reg.Nb:** Settings for warning on suggested max. regeneration process.
- Started Regen. :** Indication of how many regeneration processes started.
- Completed Reg.:** Indication of how many regeneration processes completed.
- Total Duration :** Indication of how much time of regeneration the column had

7.3.1.13 Modbus

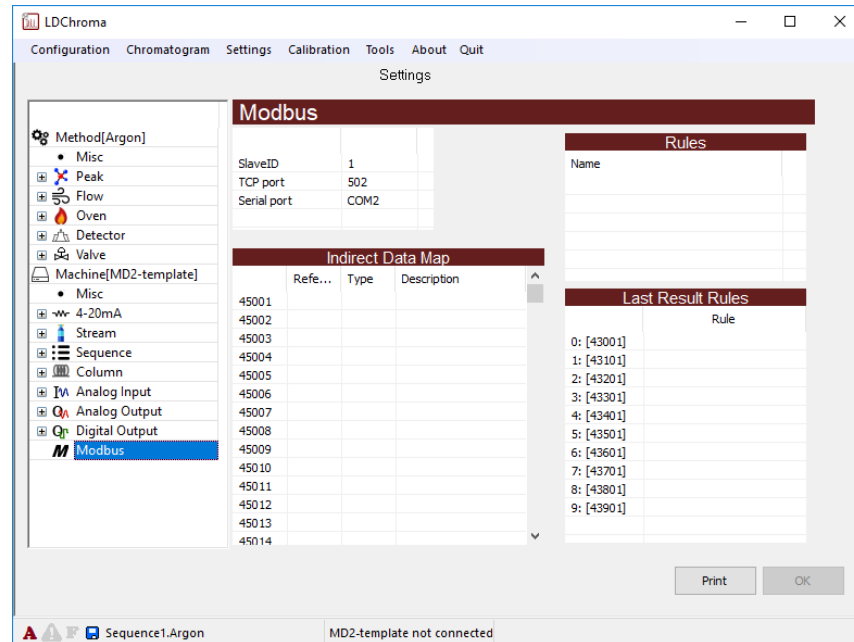

Figure 44: Modbus setting menu

Slave ID: The SlaveID is a unique number for each Slave in your Modbus network. The SlaveID can be any number between 1 and 254. If a Slave receives a communication with a wrong SlaveID, it will be ignored

High byte /High word options: Options to adapt the communication to different DCS default language

TCP port: This is the TCP port used for Modbus. For now, it is impossible to choose another value than 502

Indirect Data Map: Indirect Data Map is an advanced feature to regroup any other register in a single adjacent area

Rules: Rules are used with the Last Results Registers

Last Result Rules In the Modbus mapping, there is an area for the 10 last results. By default (if no rules are used) the latest result is in result[0], the oldest is in result[9]. So when a new result arrived, result[9] is discarded, result[8] becomes result[9] and so on. If you assign a rule to a result, the result will be replaced only if the rule is respected. Could be useful if we want to assign a stream to a certain result

7.3.1.14 QMA

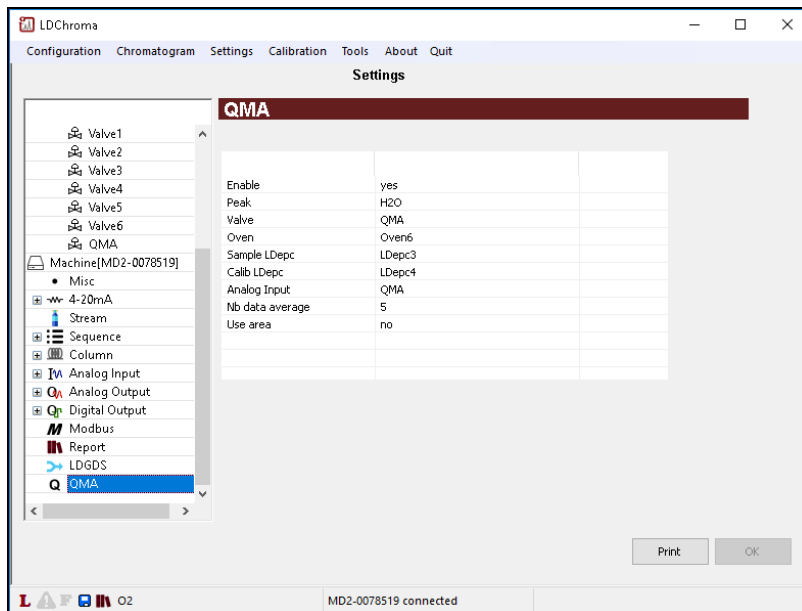

Figure 45: QMA setting menu

- Enable:** Enable or disable the QMA
- Peak:** Assign the QMA to peak.
- Valve:** Assign a valve to the QMA. The selected valve will control the sensor.
- Oven:** Assign an oven to the QMA. The selected oven will control the sensor temperature.
- Sample LDepc:** Assign the LDepc that will control the sample flow.
- Calib LDepc:** Assign the LDepc that will control the dry gas flow for QMA calibration.
- Analog input:** Select the analog input used for QMA. It as to be created as “Single Detector” first.
- Nb data average:** Choose the number of points that will be used for averaging.
- Use Area:** Chose between the calculation algorithms. The Area mode will calculate the area of a complete cycle. The Delta mode will calculate the height of the signal during each cycle.

7.4 Calibration Menu

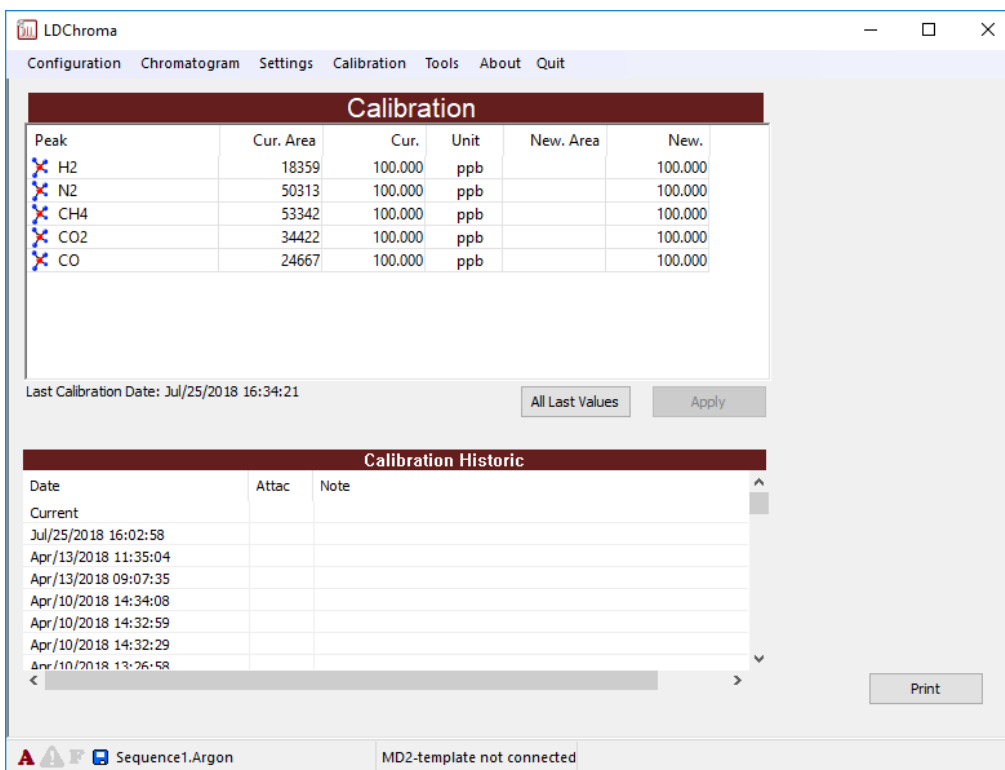
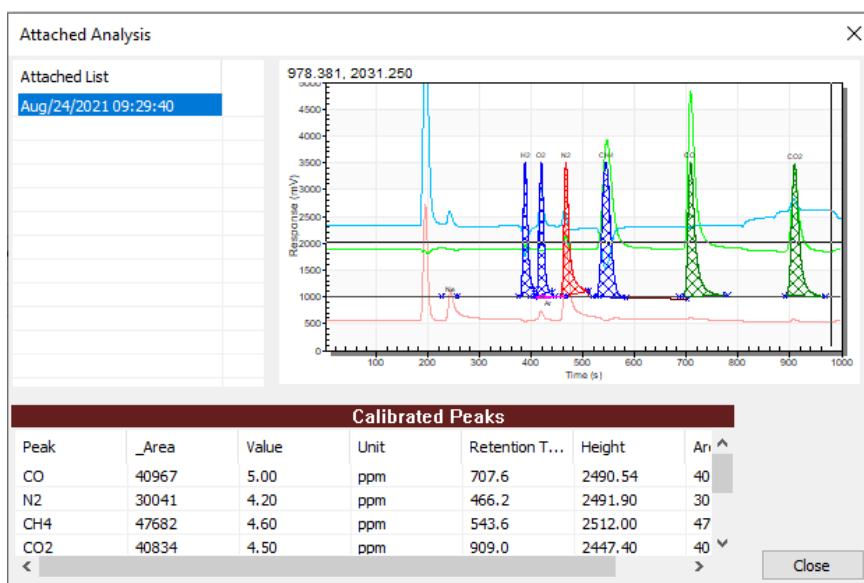
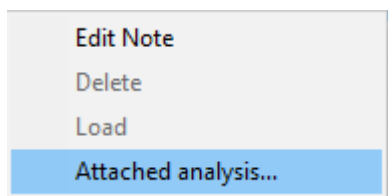

Figure 46: Calibration menu

- Peak:** The name of the impurities
- Cur. Area:** The area of the current calibration
- Cur.:** The concentration of the current calibration
- New Area:** The area of the new calibration
- New.:** The concentration of the new calibration
- All Last Value:** To load the area of the previous cycle under “New Area”
- Apply:** To save all the change that were made
- Calibration Historic:** It displays the historic of the previous calibration. It is possible to load a previous one if needed by right-clicking on a date and selecting “Load”.

It is also possible to see the chromatogram with values of a previous calibration by right-clicking on a date and selecting “Attached analysis” A chromatogram will show in a pop up window as shown below.



7.5 Diagnostics Menu

7.5.1 Analog input

This menu displays all analog inputs in the MultiDetek2 with their actual value in counts and converted into units.

The progress bar in the corner shows the refreshing rate

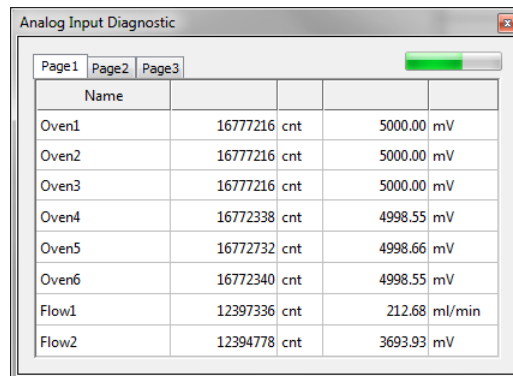

Analog Input Diagnostic				
Page1 Page2 Page3				
Name				
Oven1	16777216	cnt	5000.00	mV
Oven2	16777216	cnt	5000.00	mV
Oven3	16777216	cnt	5000.00	mV
Oven4	16772338	cnt	4998.55	mV
Oven5	16772732	cnt	4998.66	mV
Oven6	16772340	cnt	4998.55	mV
Flow1	12397336	cnt	212.68	ml/min
Flow2	12394778	cnt	3693.93	mV

Figure 47: Analog input window

7.5.2 Analog output

This menu displays all analog output in the MultiDetek2 with their actual value in counts and converted into units. You can also force any value for diagnostic purposes.

The progress bar in the corner shows the refreshing rate.

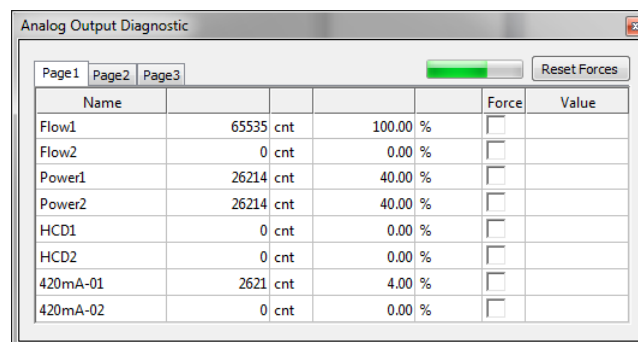

Analog Output Diagnostic					
Page1 Page2 Page3					
Name				Force	Value
Flow1	65535	cnt	100.00 %	<input type="checkbox"/>	
Flow2	0	cnt	0.00 %	<input type="checkbox"/>	
Power1	26214	cnt	40.00 %	<input type="checkbox"/>	
Power2	26214	cnt	40.00 %	<input type="checkbox"/>	
HCD1	0	cnt	0.00 %	<input type="checkbox"/>	
HCD2	0	cnt	0.00 %	<input type="checkbox"/>	
420mA-01	2621	cnt	4.00 %	<input type="checkbox"/>	
420mA-02	0	cnt	0.00 %	<input type="checkbox"/>	

Figure 48: Analog output window

7.5.3 Digital output

This menu displays all digital output in the MultiDetek2 with their actual value. If the square is grey, the state of the output is unknown (probably a communication problem), if the square is dark green, the output is OFF, if the square is light green, the output is ON.

You can force any output at OFF or ON. When a state is forced, an “F” is displayed in the square.

The progress bar in the corner shows the refreshing rate.

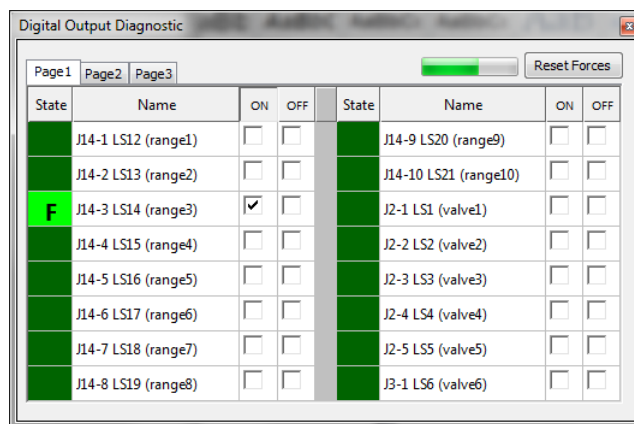

Figure 49: Digital output window

7.5.4 LDepc

This menu displays the communication status, the actual flow, the actual pressure, the flow table and the PID of the LDepc.

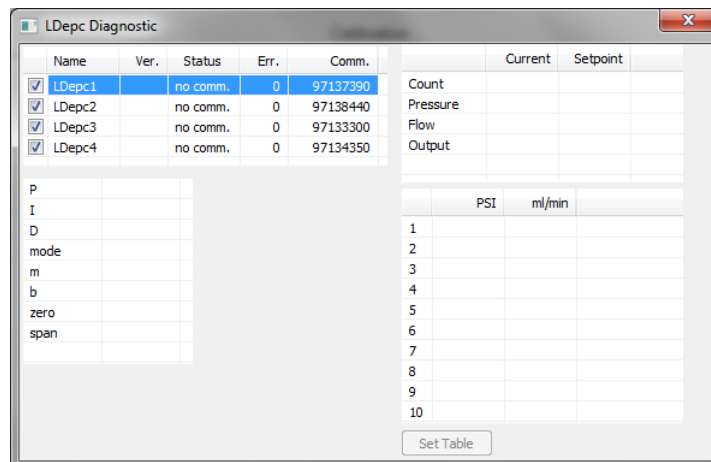

Figure 50: LDepc diagnostic window

7.5.5 Modbus/Register

This menu displays the actual values of every Modbus registers

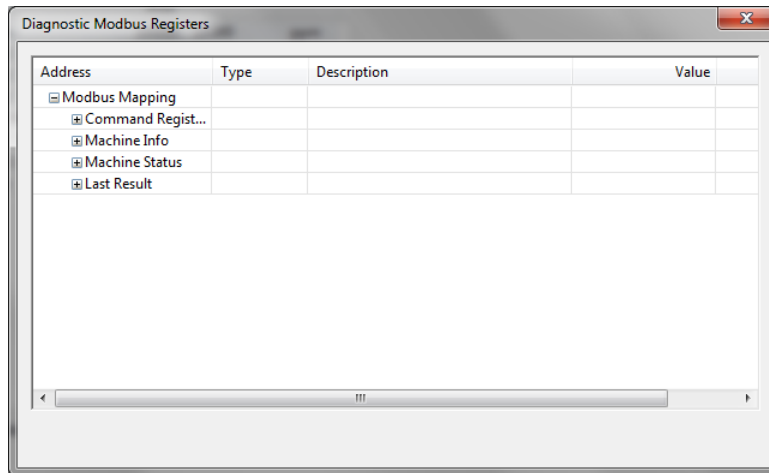

Figure 51: Modbus register window

7.5.6 Modbus/Connection

This menu displays which IP is connected the MD2 and if there is some activity (send and receive data)

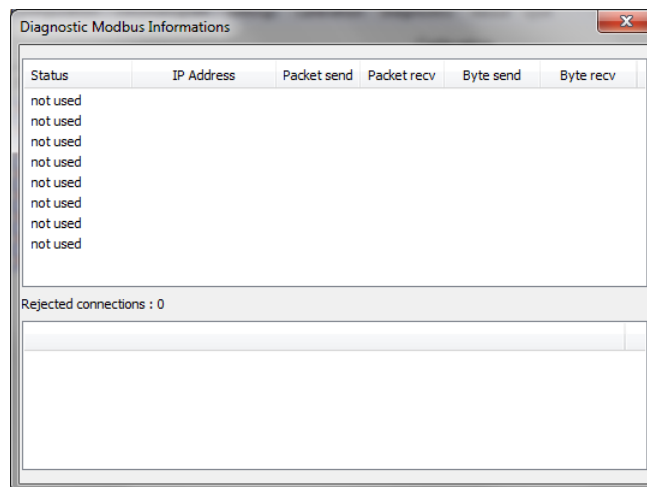

Figure 52: Modbus information window

7.5.7 Idle Sensor

This menu is used to save all sensors voltages when the system is at factory. These voltage becomes the reference voltages.

7.6 Regeneration

This menu is used to start a regeneration. The settings are pre-configured in the setting menu.

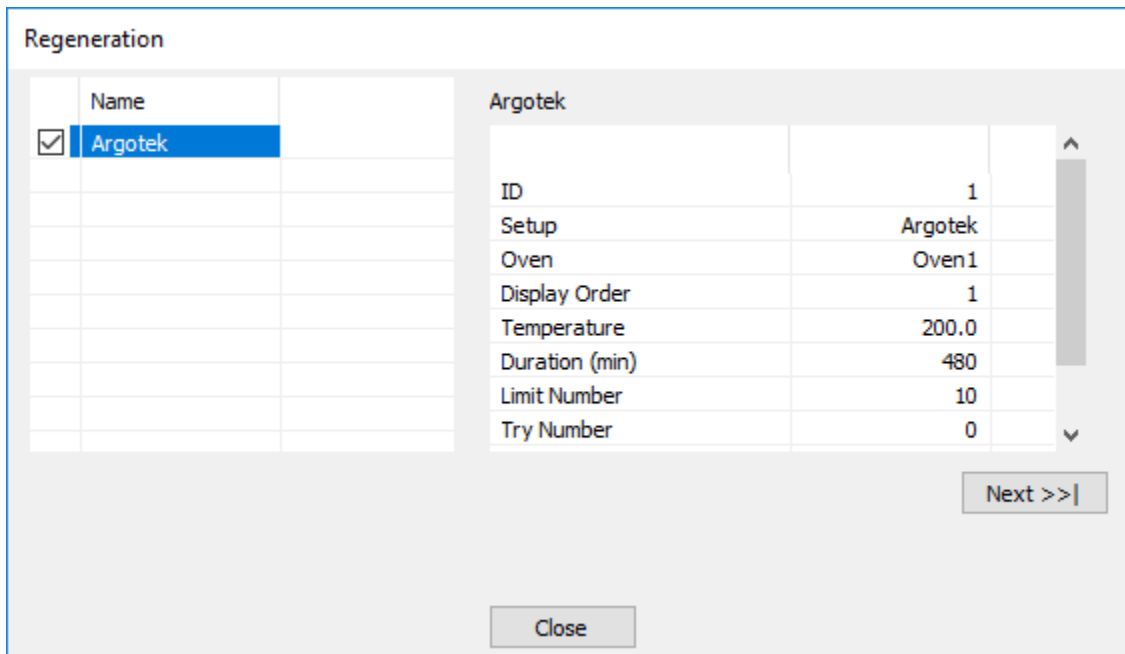

Figure 53: Regeneration window

7.7 About menu

The PC software version appears in this menu. The serial # of the unit appears as well. The firmware version of the LDPEC's and motherboard installed are also displays. It is used to evaluate the compatibility of parts and software versions installed in the unit.



Figure 54 : About menu

7.8 Firmware Update

This menu is used to update the firmware of the MultiDetek2. **A firmware update should not be done without contacting LDetek support**

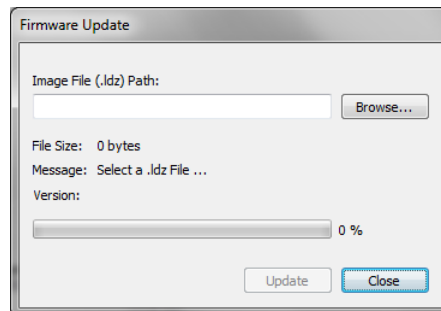

Figure 55 : Firmware Update

8.0 Backpanel terminal identification

4-20mA1+
4-20mA1-
4-20mA2+
4-20mA2-
4-20mA3+
4-20mA3-
4-20mA4+
4-20mA4-
4-20mA5-

4-20mA6+
4-20mA6-
4-20mA7+
4-20mA7-
4-20mA8+
4-20mA8-
4-20mA9+
4-20mA9-
4-20mA10+
4-20mA10-

Range 1
Range 2
Range 3
Range 4
Range 5
Range 6
Range 7
Range 8
Range 9
Range 10

COM
STATUS
Aux.
Spare
ALARM 1
ALARM 2
ChromOut+
ChromOut-
GND
GND

Stream 1
Stream 2
Stream 3
Stream 4
Stream 5
Stream 6
Stream 7
Stream 8
Spare
Spare

AUX RID +
AUX RID -
AUX heater+
AUX heater-

4-20mA1+ to 4-20mA10+: Analog output positive terminals for peak #1 to peak #10
(use 500ohm resistor between + and – terminals for 0-10VDC resolution on data recorder)

4-20mA1- to 4-20mA 10-: Analog output negative terminals for peak #1 to peak #10
(use 500ohm resistor between + and – terminals for 0-10VDC resolution on data recorder)

Range 1 to Range 10: These dry contacts can be N.O or N.C selectable in chromatogram menu. These relays are used to indicate on which range is the instrument. One relay is used for each peak. (Example : Peak 1 : Contact relay is between Range 1 and COM terminals)

COM: The COM is shared with Ranges, Status, Alarm1 and Alarm 2 terminals

STATUS: This dry contact is open when an alarm is active (The contact status is user's configurable)

Aux. : This dry contact is a spare contact (Used for options only)

ALARM1: This dry contact is open when process value is higher than the alarm1 set value

ALARM2: This dry contact is open when process value is higher than the alarm2 set value

ChromOut+: High resolution voltage Chromatogram output+ terminal (output voltage is 0-5VDC between ChromOut+ and ChromOut- terminals)

ChromOut-: High resolution voltage Chromatogram output GND terminal

GND : This is a common GND (Used as GND contact for options and Streams only)

Stream 1 to Stream 8: These dry contacts are closed when the associated stream has been selected. These contacts are used to remotely control the LDGSS stream selector system.

(Example : Stream 1 : Contact relay is between Stream 1 and GND terminals)

Spare: spare relay for options

AUX RTD+: RTD+ contact (used for auxiliary oven only)

AUX RTD-: RTD- contact (used for auxiliary oven only)

AUX Heater+: Heater+ contact (used for auxiliary oven only)

AUX Heater-: Heater- contact (used for auxiliary oven only)

9.0 Drawings & Schematics

Unit dimensions and cut out dimensions

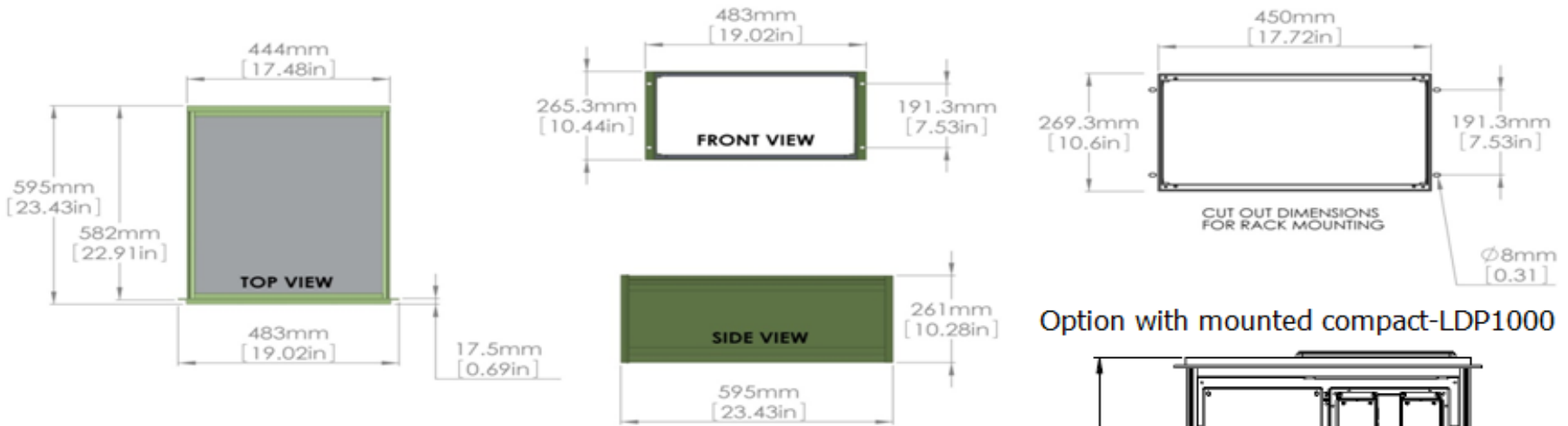

Option with mounted compact-LDP1000

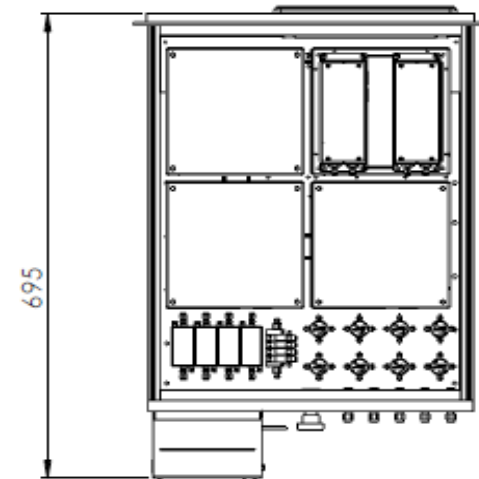

Back Panel (Complete assembly)
Top section is for gas connections
Bottom section is removable on track to have an easy access to inside electronic components.

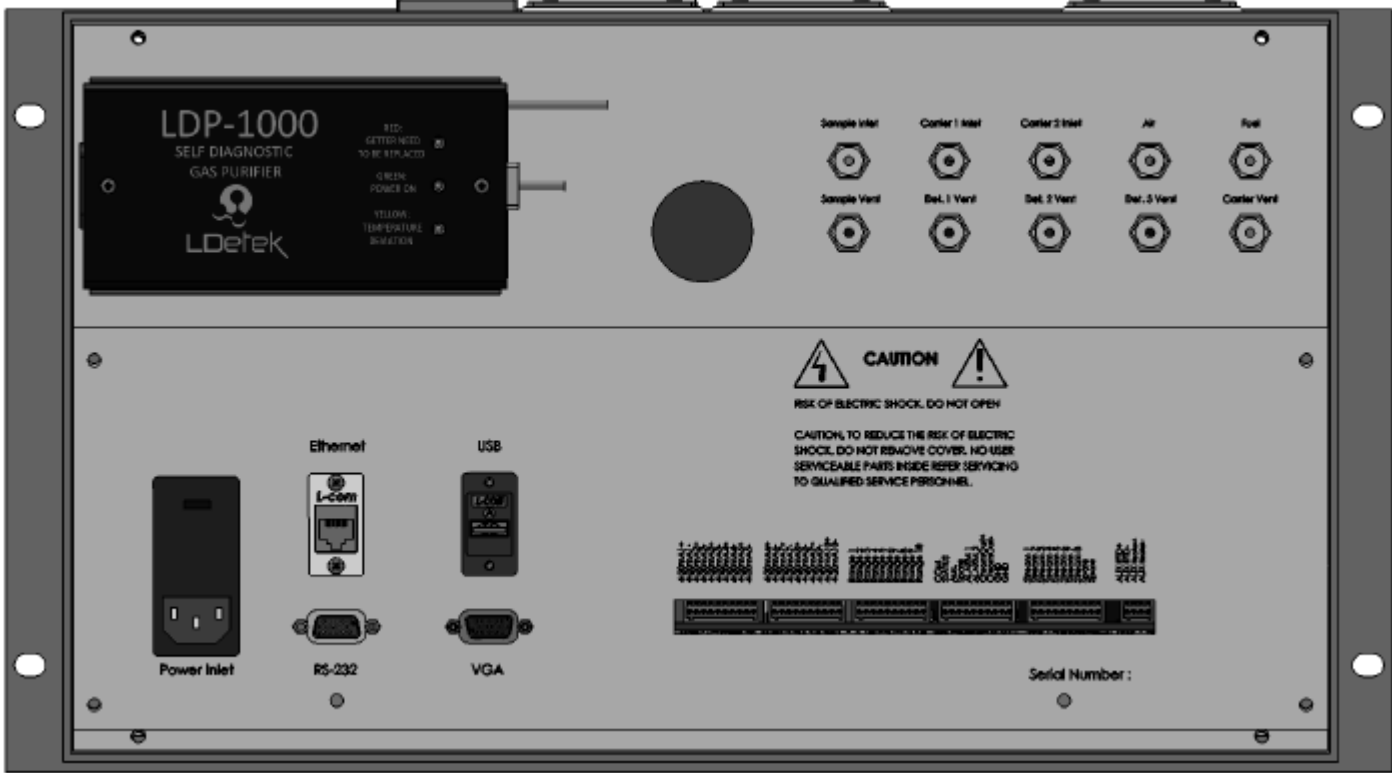

Back Panel (Bottom section is for electrical connections)
 Bottom section is removable on track to have access to inside components.

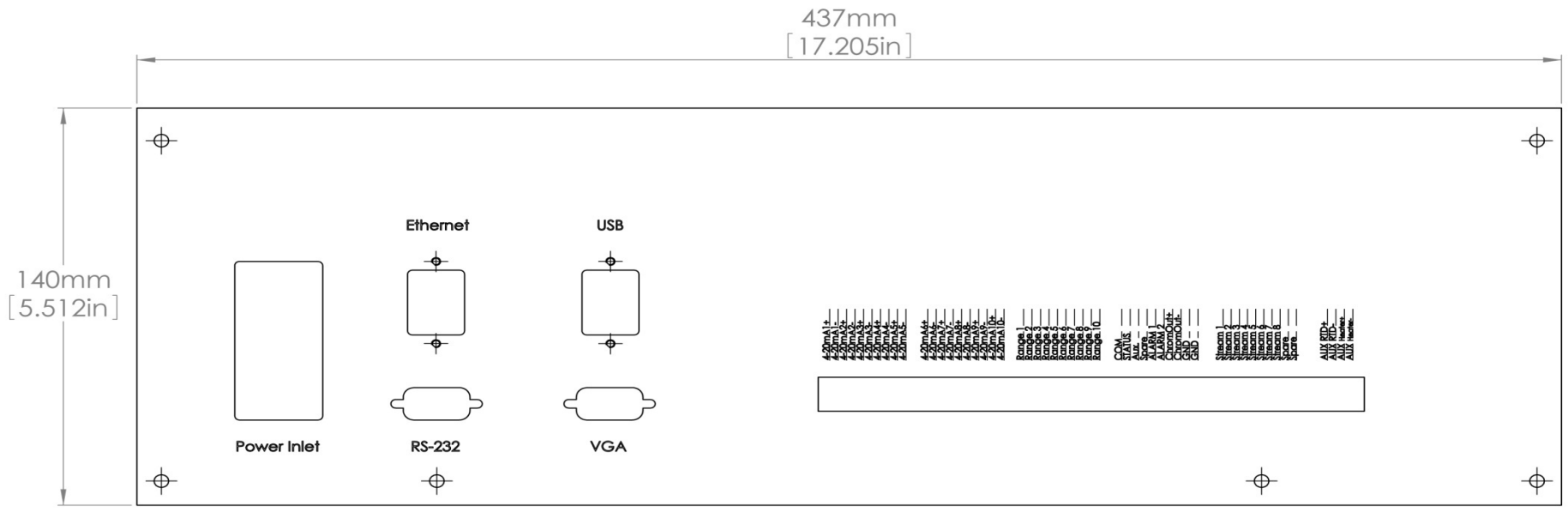

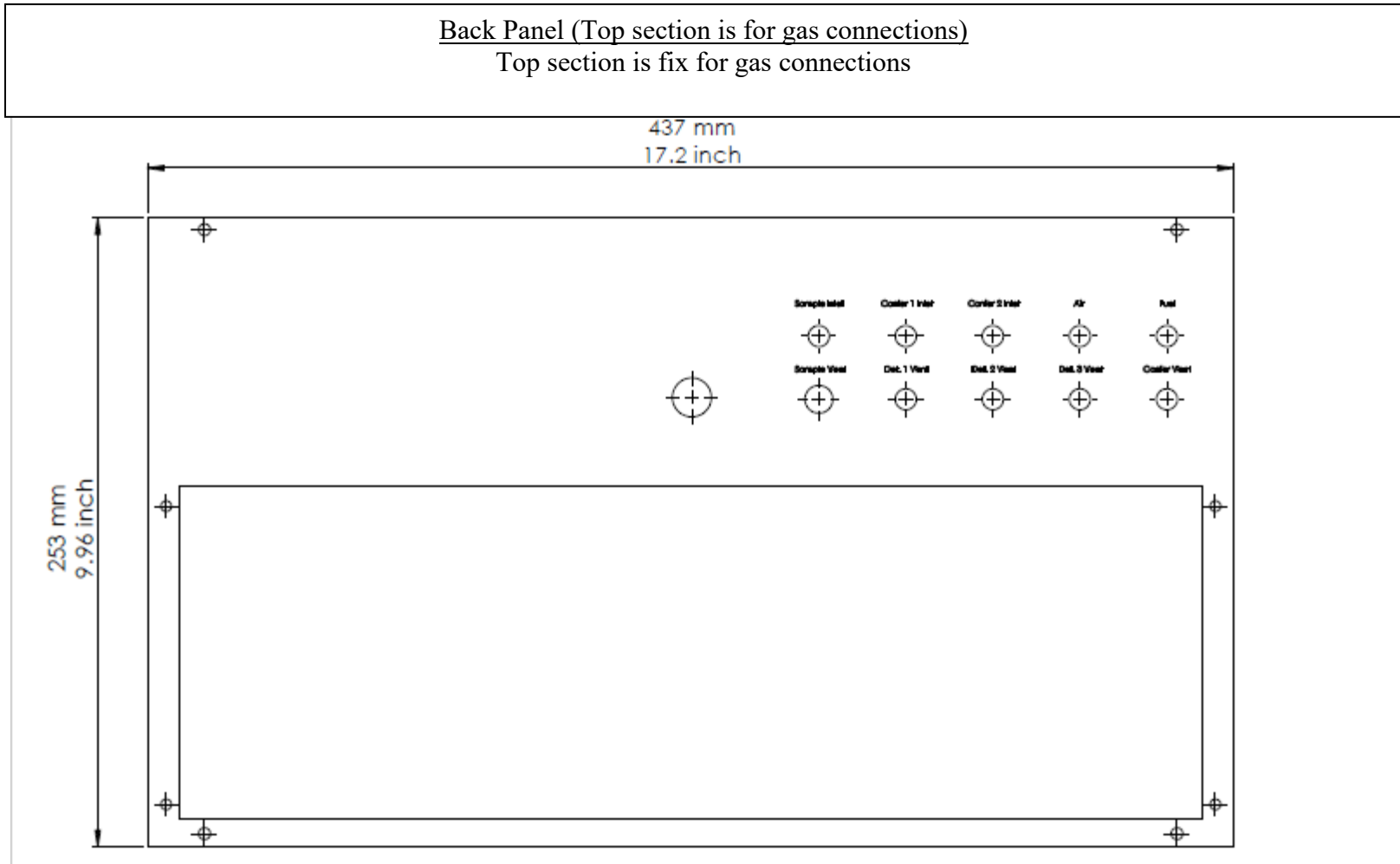

Top and bottom rack section

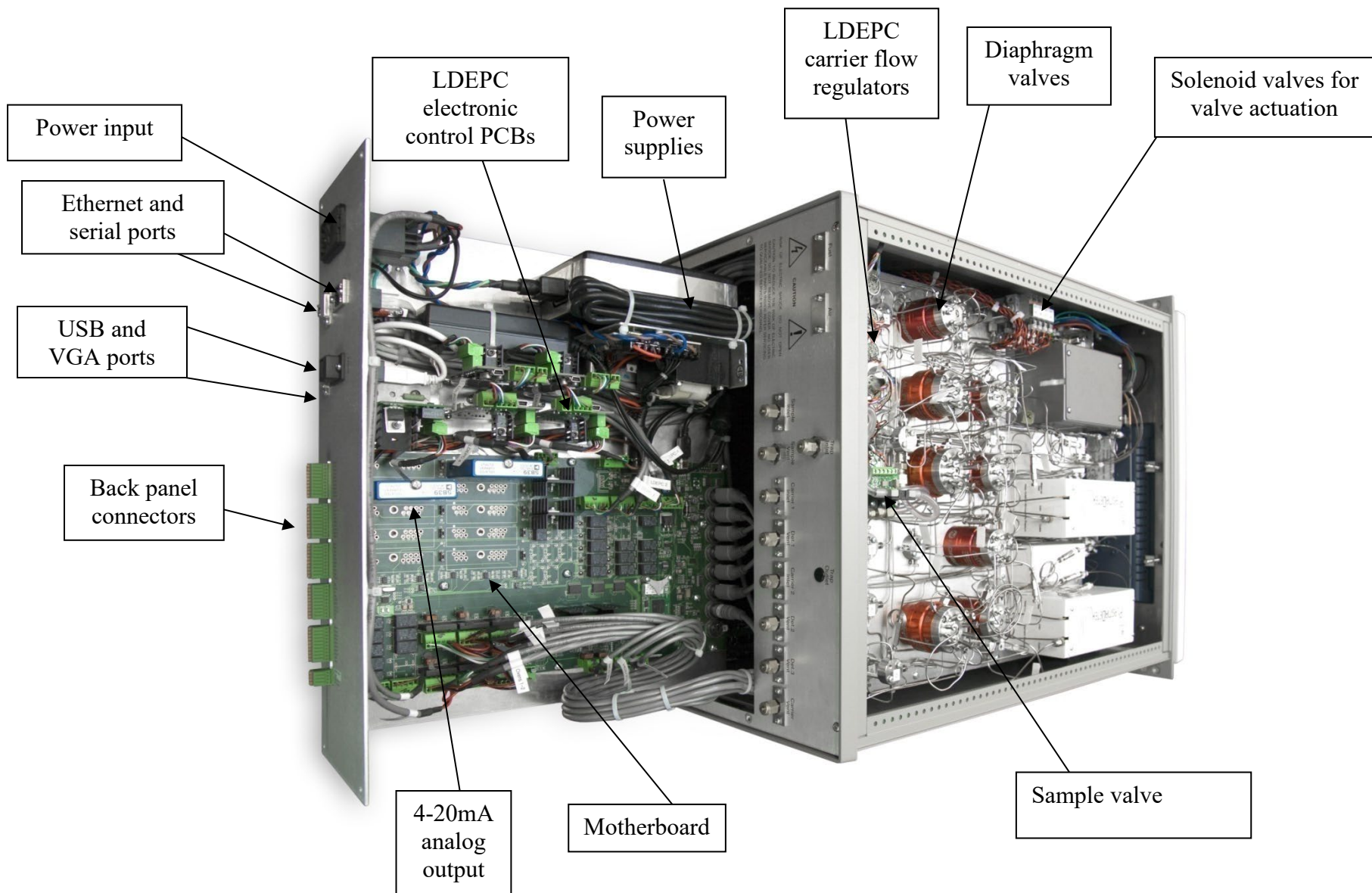

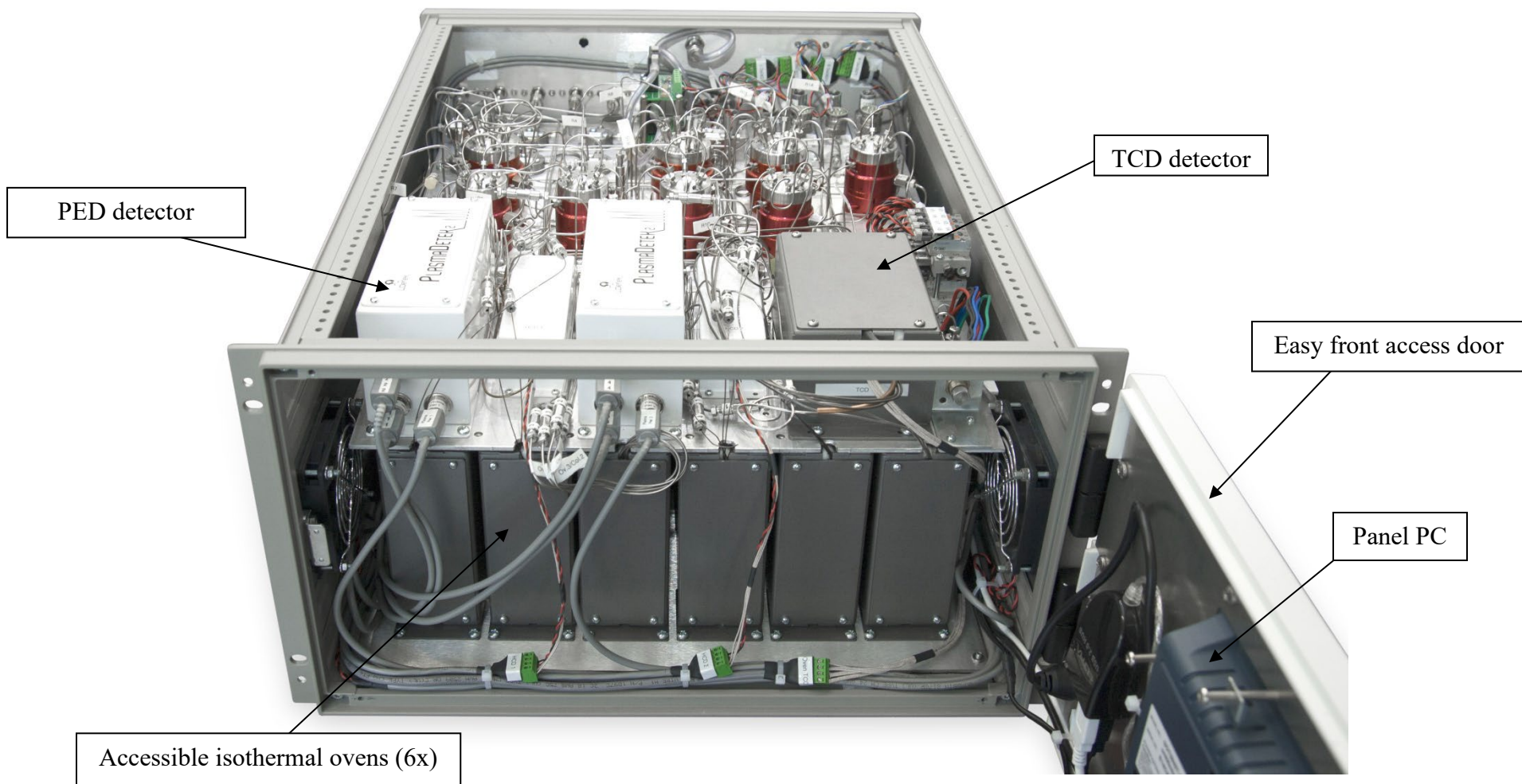

MotherBoard PCB

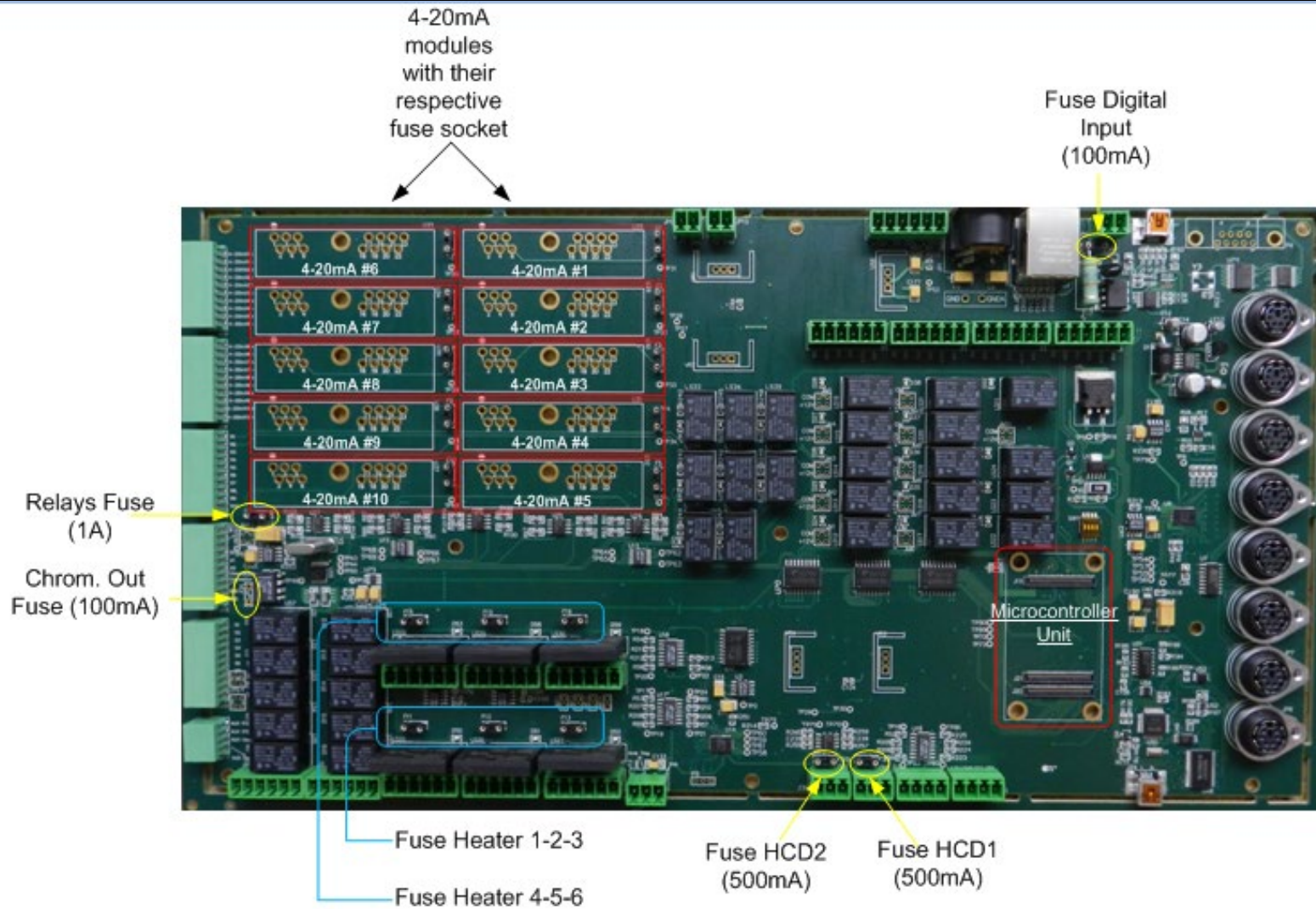

Motherboard PCB electrical connections.

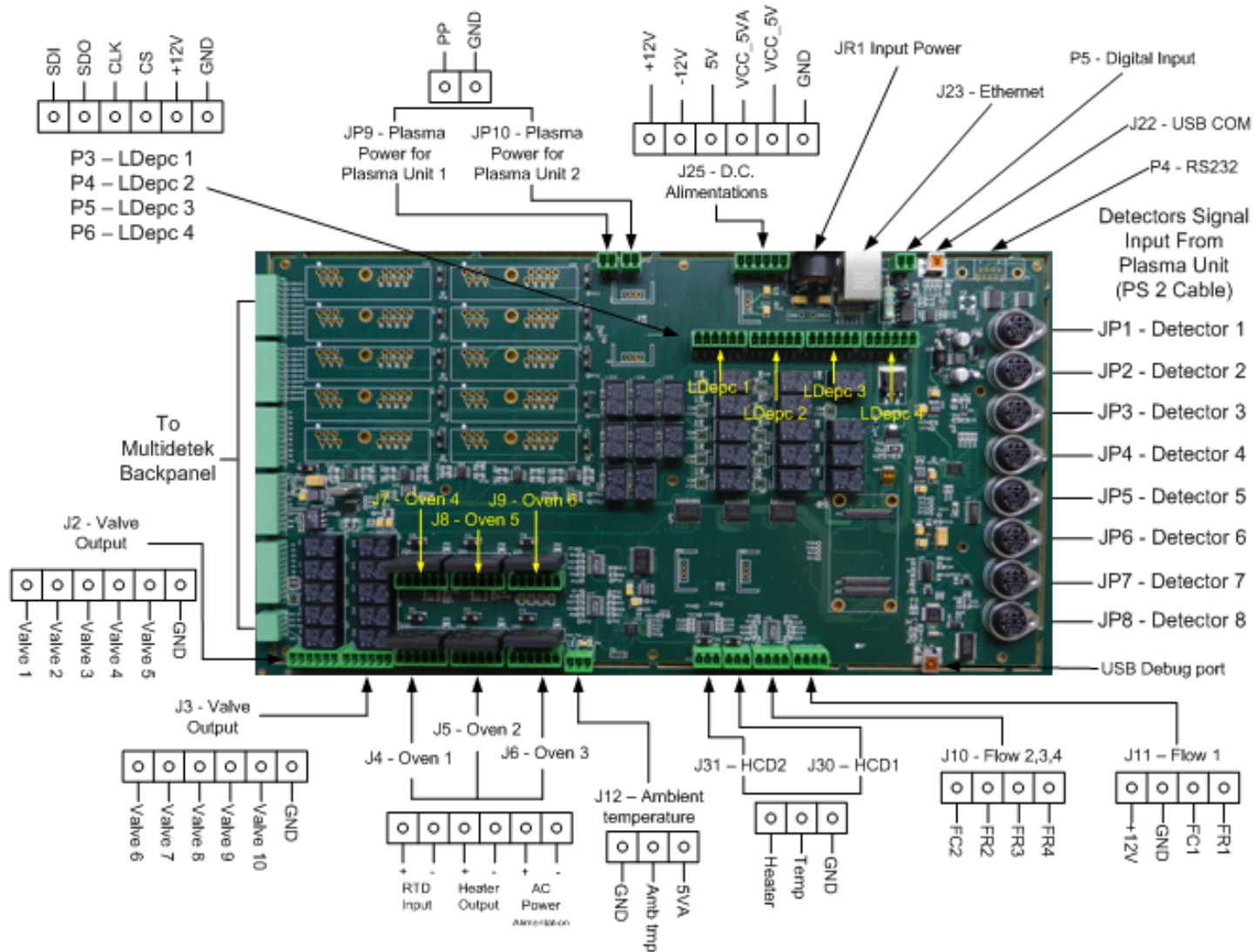

10.0 Maintenance

Referring to the spare part list: the manufacturer item numbers, the descriptions, the replacement frequencies as well as the associated procedure numbers are identified.

10.1 Spare part list

Contact LDetek service department (support@ldetek.com) with the serial number of your instrument for the spare part list referring to your instrument.

10.2 Frequently asked questions

Problems	Solutions (by priority)
Low flow on sample	<ol style="list-style-type: none">1. Check if the sample flow setpoint match the value in the document operating parameters2. Check if the sample pressure match the value in the document operating parameters3. Measure the flow with a flow meter connected at the sample vent of the unit4. Contact LDetek support (support@ldetek.com) with the results obtained in the previous steps
Low flow on LDepe	<ol style="list-style-type: none">1. Check if the carrier pressure match the value in the document operating parameters2. Increase the carrier pressure by 20 PSIG to see if the carrier flow stabilize on the setpoint3. Set the carrier pressure at the value in the operating parameters to see if the flow stabilize on the setpoint4. Decrease the carrier pressure by 20 PSIG to see if the carrier flow stabilize on the setpoint5. Try to bypass the gas purifier to see if the carrier setpoint come back to normal.6. Contact LDetek support (support@ldetek.com) with the results obtained in the previous steps

Oven temperature deviation	<ol style="list-style-type: none"> 1. Check if the setpoint match the value in the operating parameter 2. Open the front door and check if connectors are well connected for each oven 3. Refer to drawing ‘‘Motherboard PCB’’ of the drawing section 8.0 to identify the fuse used for each oven. Check if the fuses are not blown by removing them and measuring the continuity of it 4. Check the status of the LED used for the defective oven. Refer to the drawing ‘‘Motherboard PCB’’ of the drawing section 8.0. The green LED turns on when the oven is heating. Check if the LED is ON or OFF or blinking. If the setpoint is 50Celsius and the reading value is 10Celsius, then the LED should be ON all the time 5. Contact LDetek support (support@ldetek.com) with the results obtained in the previous steps
Detector off alarm	<ol style="list-style-type: none"> 1. Check the raw signals referring to the operating parameter sheet (refer to start up procedure section 4.3) 2. Contact LDetek support (support@ldetek.com) with the results obtained in the previous steps
Lost peaks	<ol style="list-style-type: none"> 1. Check if there are flow alarms and resolve them 2. Check if there are oven temperature deviation alarms and resolve them 3. Check if there are detector off alarm and resolve them 4. Check the raw signals of the detectors by referring to the operating parameter. The raw signal must be at a value +/- 20% of the factory values. To see the raw signals, refer to the start-up procedure section 4.3 5. Contact LDetek support (support@ldetek.com) with the results obtained in the previous steps
Display off or unit doesn't start	<ol style="list-style-type: none"> 1. Check if the green LED is ON on the right bottom corner 2. If the green LED is OFF, then check if power is well supply to the unit. Make sure it is the right power voltage by referring to the model number of the instrument or the red indicator on the power inlet module on the back panel

	<ol style="list-style-type: none"> 3. If the green LED is OFF and power is correct. Check the fuses in the power inlet module. Be sure to remove the power inlet voltage to avoid risks of electrical shock. Remove the fuse from the module to measure the continuity of it 4. Check the connection between the power supply and the panel PC. To do so, refer to drawing ‘‘Top and bottom rack section’’ of the drawing section 8.0. By accessing the front door, check the connections on the panel PC 5. If the connections are good, then it is required to measure the voltage on the supply connector on the Panel PC. The voltage should be 19VDC 6. Contact LDetek support (support@ldetek.com) with the results obtained in the previous steps
Defective 4-20mA module	<ol style="list-style-type: none"> 1. Recalibrate the defective output according to the section 6.3.1.9 2. Refer to drawing ‘‘Motherboard PCB’’ of the drawing section 8.0 to identify the 4-20mA modules and fuses. Check if the fuse is not blown. Remove the fuse to measure the continuity of it 3. Swap the defective 4-20mA module with a known working module and test it 4. Contact LDetek support (support@ldetek.com) with the results obtained in the previous steps
Unstable reading	<ol style="list-style-type: none"> 1. Make sure there is no active alarm. If there are alarms, they must be resolved 2. Make sure the calibration has been done properly 3. Provide the followings information to a LDetek support (support@ldetek.com) : <ol style="list-style-type: none"> a) S/N of the unit b) Certified gas calibration values of the span cylinder(s) and its balance gas c) Quality of the carrier gas used d) S/N of the gas purifier installed on the unit e) 3 x screenshots of the 3 latest span gas chromatograms f) 3 x screenshots of the 3 latest analysis on the sample gas



LDetek

Where **innovation** leads to **success**