

1.1.1.2 Round Photodiode Sensors

20pW to 3W

Features

- Round geometry for easy centering
- Threaded to fit standard SM1 bench equipment
- Same performance as standard PD300 sensors
- Comes with removable filter as standard
- Fiber optic adapters available

PD300R Filter Off



PD300R Filter installed



Model	PD300R		PD300R-3W		PD300R-UV			PD300R-IR						
Use	General		Powers to 3W		Lowest powers from 200-1100nm			IR wavelengths 700-1800nm						
Detector Type	silicon		silicon		silicon			Germanium						
Aperture	Ø10mm		Ø10mm		Ø10mm			Ø5mm						
Calibration Uncertainty nm	±1.1% 430-1000 ^(a)		±1.1% 430-1000 ^(a)		±1.1% 430-1000 ^(a)			±2.4% 700-1430 ^(a)						
Filter Mode	Filter out	Filter in	Filter out	Filter in	Filter out	Filter in	Filter out	Filter in	Filter out	Filter in				
Spectral Range nm	350-1100		430-1100		350-1100		430-1100		700-1800					
Power Range	500pW to 30mW	2µW to 300mW	5nW to 100mW	2µW to 3W	20pW to 3mW	2µW to 300mW	5nW to 30mW	2µW to 300mW	5nW to 30mW	2µW to 300mW				
Power Scales	30mW to 30nW and dBm		300mW to 300µW and dBm		100mW to 300nW and dBm	3W to 300µW and dBm	3mW to 3nW and dBm	300mW to 300µW and dBm	30mW to 30nW and dBm	300mW to 300µW and dBm				
Resolution nW	0.01	NA	0.1	NA	0.001	100	0.01	NA						
Maximum Power vs. Wavelength	nm	mW	mW	nm	mW	mW	nm	mW	mW	nm	mW	mW		
	<488	30	300	<488	100	3000	250 - 350	3	300	800	12	120		
	633	20	300	633	100	3000	400	3	300	1000-1300	30	300		
	670	13	200	670	100	2000	600	3	300	1400	30	250		
	790	10	100	790	100	1200	800 - 950	2.5	150	1500	30	100		
	904	10	100	904	100	1200	1064	3	300	1600	30	100		
	1064	25	250	1064	100	2200				1800	30	300		
Accuracy (including errors due to temp. variations)														
% error vs Wavelength nm	±10	360-400	NA	±10	360-400	NA	±10	200-230	±10	220-300	±5	700-800	±6	700-900
	±3	400-980	±5	430-980	±3	400-950	±5	430-950	±4	300-420	±4	800-1700	±5	900-1700
	±5	980-1100	±7	980-1100	±4	950-1030	±6	950-1030	±3	420-980	±7	1700-1800	±9	1700-1800
					±6	1030-1100	±7	1030-1100	±2	420-980	±7			
									±7	980-1100				
Damage Threshold W/cm2	10		50		10		30		10		50			
Max Pulse Energy µJ	3		30		30		400		1		50		0.75 2	
Noise Level for filter out pW	20				200				±1		200			
Response Time with Meter s	0.2				0.2				0.2		0.2			
Beam Position Dependence	±2%				±2%		±3%		±2%		±2%			
Fiber Adapters Available (see page 32)	ST, FC, SMA, SC				ST, FC, SMA, SC				ST, FC, SMA, SC				ST, FC, SMA, SC	
Compliance Version	CE, UKCA, China RoHS				CE, UKCA, China RoHS				CE, UKCA, China RoHS				CE, UKCA, China RoHS	
Part Number	7Z02436		7Z02437		7Z02438			7Z02439						

Notes: (a) For calibration uncertainty of wavelengths outside of this range see table on page 24

* For graphs see page 30-31

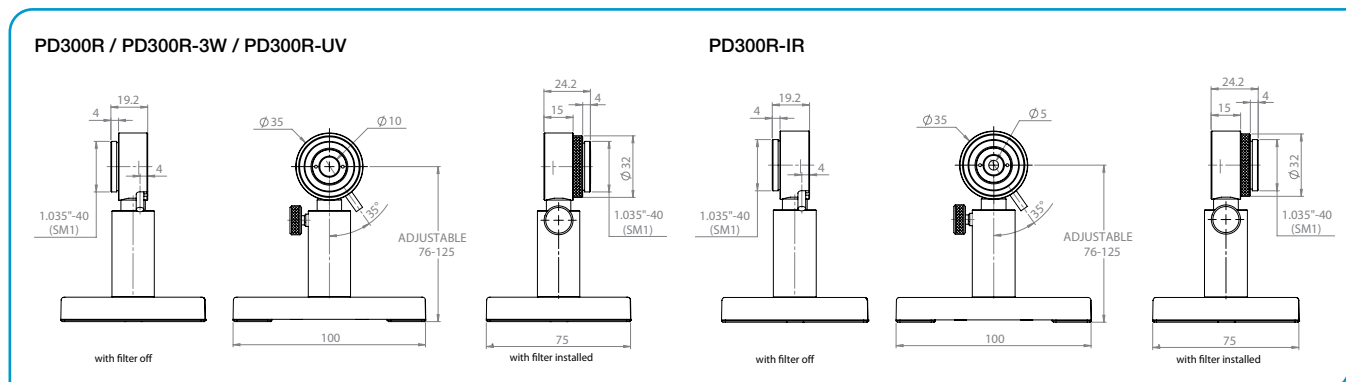

Temperature Coefficient of Sensitivity

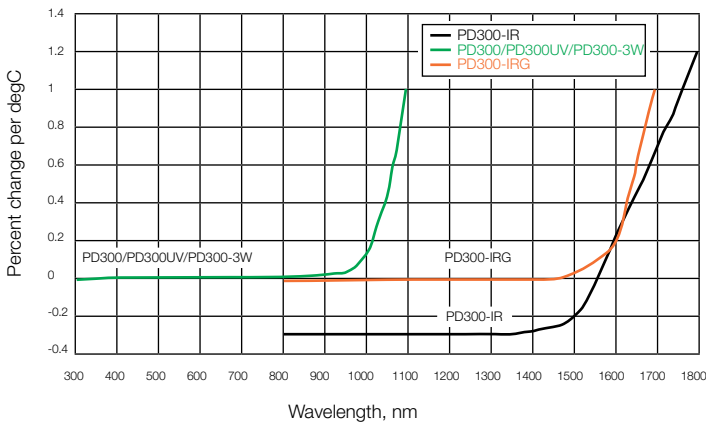

PD300 Angle Dependence

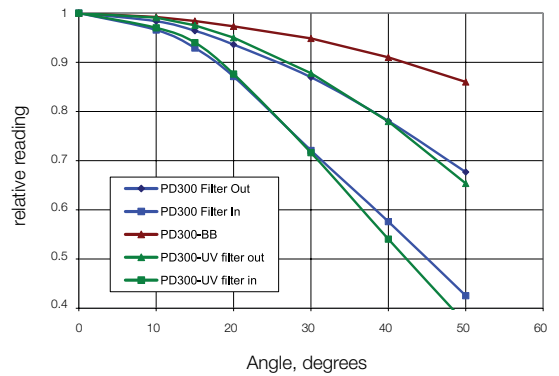

Dependence of Sensitivity on Numerical Aperture (PD300 - IRG)

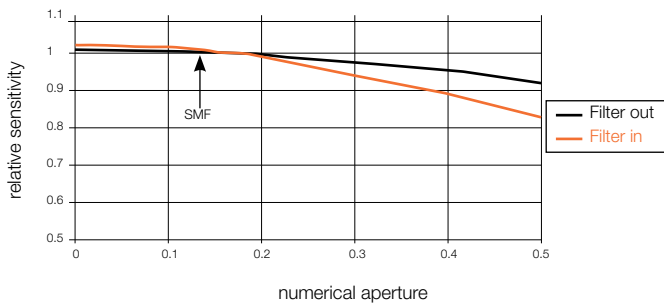

Note:
 1. Graph assumes equal intensity into all angles up to maximum N.A.
 2. Calibration is done with SMF, N.A. 0.13

PD300-CIE Spectral Response vs. CIE Curve

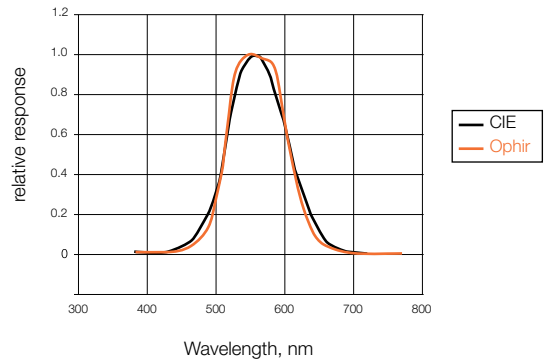

Typical Sensitivity Curve of PD300-BB Sensors

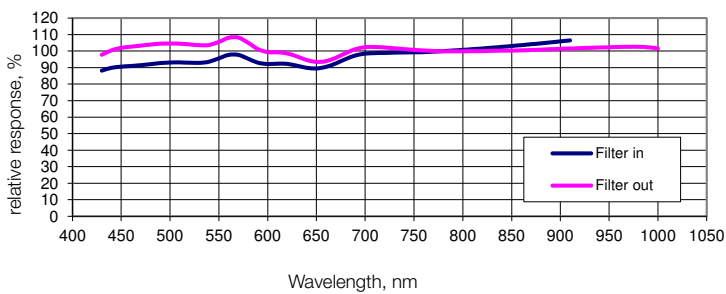

BC20 Relative Spectral Response

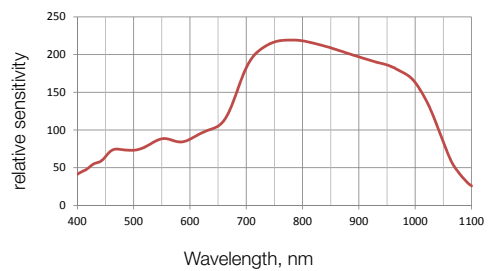

Approximate Spectral Response

Relative to 633nm or 1550nm

