

apogee[®]

INSTRUMENTS

OWNER'S MANUAL

PYRANOMETER

Models SP-510-SS and SP-610-SS

Rev: 16-Sept-2022

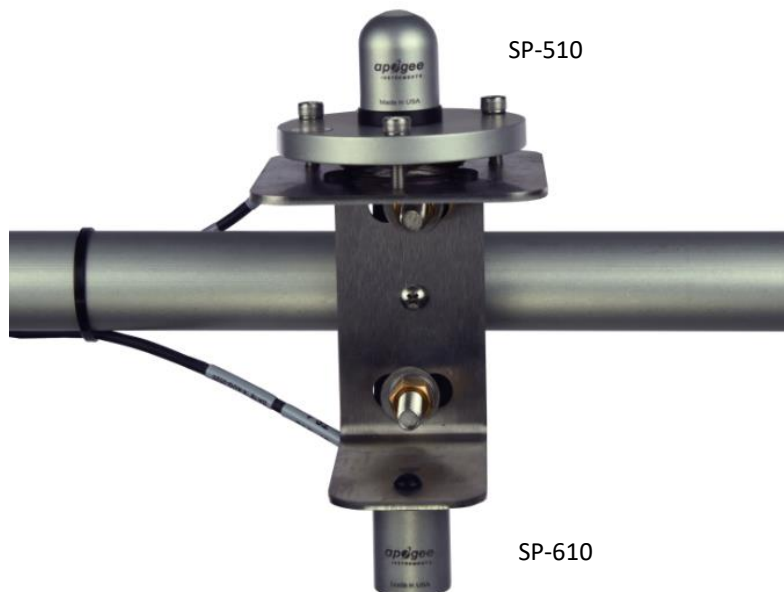

APOGEE INSTRUMENTS, INC. | 721 WEST 1800 NORTH, LOGAN, UTAH 84321, USA
TEL: (435) 792-4700 | FAX: (435) 787-8268 | WEB: APOGEEINSTRUMENTS.COM

Copyright © 2022 Apogee Instruments, Inc.

TABLE OF CONTENTS

Owner’s Manual 1

 Certificates of Compliance 3

 Introduction 5

 Sensor Models 6

 Specifications 7

 Deployment and Installation..... 9

 Cable Connectors 10

 Operation and Measurement 11

 Maintenance and Recalibration 13

 Troubleshooting and Customer Support..... 15

 Return and Warranty Policy 16

CERTIFICATE OF COMPLIANCE

EU Declaration of Conformity

This declaration of conformity is issued under the sole responsibility of the manufacturer:

Apogee Instruments, Inc.
721 W 1800 N
Logan, Utah 84321
USA

for the following product(s):

Models: SP-510, SP-610
Type: Pyranometer

The object of the declaration described above is in conformity with the relevant Union harmonization legislation:

2014/30/EU	Electromagnetic Compatibility (EMC) Directive
2011/65/EU	Restriction of Hazardous Substances (RoHS 2) Directive
2015/863/EU	Amending Annex II to Directive 2011/65/EU (RoHS 3)

Standards referenced during compliance assessment:

EN 61326-1:2013	Electrical equipment for measurement, control, and laboratory use – EMC requirements
EN 63000:2018	Technical documentation for the assessment of electrical and electronic products with respect to the restriction of hazardous substances

Please be advised that based on the information available to us from our raw material suppliers, the products manufactured by us do not contain, as intentional additives, any of the restricted materials including lead (see note below), mercury, cadmium, hexavalent chromium, polybrominated biphenyls (PBB), polybrominated diphenyls (PBDE), bis (2-ethylhexyl) phthalate (DEHP), butyl benzyl phthalate (BBP), dibutyl phthalate (DBP), and diisobutyl phthalate (DIBP). However, please note that articles containing greater than 0.1 % lead concentration are RoHS 3 compliant using exemption 6c.

Further note that Apogee Instruments does not specifically run any analysis on our raw materials or end products for the presence of these substances, but we rely on the information provided to us by our material suppliers.

Signed for and on behalf of:
Apogee Instruments, September 2022



Bruce Bugbee
President
Apogee Instruments, Inc.



CERTIFICATE OF COMPLIANCE

UK Declaration of Conformity

This declaration of conformity is issued under the sole responsibility of the manufacturer:

Apogee Instruments, Inc.
721 W 1800 N
Logan, Utah 84321
USA

for the following product(s):

Models: SP-510, SP-610
Type: Pyranometer

The object of the declaration described above is in conformity with the relevant UK Statutory Instruments and their amendments:

2016 No. 1091	The Electromagnetic Compatibility Regulations 2016
2012 No. 3032	The Restriction of the Use of Certain Hazardous Substances in Electrical and Electronic Equipment Regulations 2012

Standards referenced during compliance assessment:

BS EN 61326-1:2013	Electrical equipment for measurement, control, and laboratory use – EMC requirements
BS EN 63000:2018	Technical documentation for the assessment of electrical and electronic products with respect to the restriction of hazardous substances

Please be advised that based on the information available to us from our raw material suppliers, the products manufactured by us do not contain, as intentional additives, any of the restricted materials including lead (see note below), mercury, cadmium, hexavalent chromium, polybrominated biphenyls (PBB), polybrominated diphenyls (PBDE), bis (2-ethylhexyl) phthalate (DEHP), butyl benzyl phthalate (BBP), dibutyl phthalate (DBP), and diisobutyl phthalate (DIBP). However, please note that articles containing greater than 0.1 % lead concentration are RoHS 3 compliant using exemption 6c.

Further note that Apogee Instruments does not specifically run any analysis on our raw materials or end products for the presence of these substances, but we rely on the information provided to us by our material suppliers.

Signed for and on behalf of:
Apogee Instruments, September 2022



Bruce Bugbee
President
Apogee Instruments, Inc.



INTRODUCTION

Solar radiation at Earth's surface is typically defined as total radiation across a wavelength range of 280 to 4000 nm (shortwave radiation). Total solar radiation, direct beam and diffuse, incident on a horizontal surface is defined as global shortwave radiation, or shortwave irradiance (incident radiant flux), and is expressed in Watts per square meter (W m^{-2} , equal to Joules per second per square meter).

Pyranometers are sensors that measure global shortwave radiation. Apogee SP-500 and SP-600 series pyranometers are blackbody thermopile pyranometers, and are sensitive to most of the solar spectrum, thus eliminating spectral errors associated with silicon-cell pyranometers. The SP-510 is designed to measure incoming shortwave radiation and combines a diffuser with the blackbody detector. The SP-610 is designed to measure reflected shortwave radiation from terrestrial surfaces and combines a quartz window with the blackbody detector. Both models have calibrations traceable to secondary standard blackbody thermopile pyranometers traceable to the world radiation reference in Davos, Switzerland. Specifications for both models compare favorably to specifications for World Meteorological Organization (WMO) moderate and good quality classifications and specifications for International Organization of Standardization (ISO) Class C and Class B classifications.

Typical applications of pyranometers include incoming shortwave radiation measurement in agricultural, ecological, and hydrological weather networks and solar panel arrays.

Apogee Instruments SP-510 and SP-610 pyranometers consist of a thermopile detector, acrylic diffuser (SP-510) or glass window (SP-610), heater, and signal processing circuitry mounted in an anodized aluminum housing, and a cable to connect the sensor to a measurement device. Sensors are potted solid with no internal air space and are designed for continuous measurement of shortwave radiation from the sky (SP-510) and terrestrial surfaces (SP-610) in outdoor environments. SP-510 and SP-610 pyranometers output an analog voltage that is directly proportional to incident shortwave radiation. The analog signal from the sensor is directly proportional to radiation incident on a planar surface (does not have to be horizontal), where the radiation emanates from all angles of a hemisphere.

SENSOR MODELS

Apogee SP-510 and SP-610 pyranometers covered in this manual are analog versions that provide a voltage output. Apogee offers the SP-510 for incoming shortwave radiation measurements (upward-looking sensor) and SP-610 for reflected shortwave radiation measurements (downward-looking sensor).



SP-510
Upward-looking sensor



SP-610
Downward-looking sensor



A sensor's model number and serial number are located near the pigtail leads on the sensor cable. If you need the manufacturing date of your sensor, please contact Apogee Instruments with the serial number of your sensor.

SPECIFICATIONS

	SP-510	SP-610
ISO 9060:2018	Class C (fast response)	N/A
Sensitivity (variable from sensor to sensor, typical values listed) Serial # 2136 (SP-510), 1320 (SP-610) and above	0.045 mV per W m ⁻²	0.035 mV per W m ⁻²
Sensitivity (variable from sensor to sensor, typical values listed) Serial # 0-2135 (SP-510), 0-1319 (SP-610)	0.05 mV per W m ⁻²	0.15 mV per W m ⁻²
Calibration Factor (reciprocal of sensitivity) (variable from sensor to sensor, typical values listed) Serial # 2136 (SP-510), 1320 (SP-610) and above	22 W m ⁻² per mV	28.5 W m ⁻² per mV
Calibration Factor (reciprocal of sensitivity) (variable from sensor to sensor, typical values listed) Serial # 0-2135 (SP-510), 0-1319 (SP-610)	20 W m ⁻² per mV	6.7 W m ⁻² per mV
Calibration Uncertainty at 1000 W m ⁻²	Less than 3 %	
Calibrated Output Range Serial # 2136 (SP-510), 1320 (SP-610) and above	0 to 90 mV	0 to 70 mV
Calibrated Output Range Serial # 0-2135 (SP-510), 0-1319 (SP-610)	0 to 100 mV	0 to 300 mV
Measurement Range	0 to 2000 W m ⁻² (net shortwave radiation)	
Measurement Repeatability	Less than 1 %	
Long-term Drift (Non-stability)	Less than 2 % per year	
Non-linearity	Less than 1 %	
Detector Response Time	0.5 s	
Field of View	180°	150°
Spectral Range (wavelengths where response is 50 % of maximum) Serial # 2136 (SP-510), 1320 (SP-610) and above	385 to 2105 nm	370 to 2240 nm
Spectral Range (wavelengths where response is 50 % of maximum) Serial # 0-2135 (SP-510), 0-1319 (SP-610)	385 to 2105 nm	295 to 2685 nm
Directional (Cosine) Response Serial # 2136 (SP-510), 1320 (SP-610) and above	Less than 30 W m ⁻² up to solar zenith angles of 80°	Less than 20 W m ⁻² for angles between 0 and 60°
Directional (Cosine) Response Serial # 0-2135 (SP-510), 0-1319 (SP-610)	Less than 30 W m ⁻² up to solar zenith angles of 80°	Less than 20 % for angles between 0 and 60°
Temperature Response	Less than 5 % from -15 to 45 C	
Zero Offset A Serial # 2136 (SP-510), 1320 (SP-610) and above	Less than 2 W m ⁻² ; Less than 10 W m ⁻² (heated)	Less than 2 W m ⁻² ; Less than 10 W m ⁻² (heated)
Zero Offset A Serial # 0-2135 (SP-510), 0-1319 (SP-610)	Less than 5 W m ⁻² ; Less than 10 W m ⁻² (heated)	
Zero Offset B	Less than 5 W m ⁻²	
Uncertainty in Daily Total	Less than 5 %	
Operating Environment	-50 to 80 C; 0 to 100 % relative humidity	
Heater	780 Ω, 15.4 mA current draw and 185 mW power requirement at 12 V DC	
Mass	90 g	100 g
Cable	5 m of four conductor, shielded, twisted-pair wire; TPR jacket (high water resistance, high UV stability, flexibility in cold conditions); pigtail lead wires; stainless steel (316), M8 connector located 25 cm from sensor head	
Warranty	4 years against defects in materials and workmanship	

Calibration Traceability

Apogee Instruments SP-500 and SP-600 series pyranometers are calibrated through side-by-side comparison to the mean of four Apogee model SP-510 or model SP-610 transfer standard pyranometers (shortwave radiation reference) under high intensity discharge metal halide lamps. The transfer standard pyranometers are calibrated through side-by-side comparison to the mean of at least two ISO-classified reference pyranometers under sunlight (clear sky conditions) in Logan, Utah. Each of four ISO-classified reference pyranometers are recalibrated on an alternating year schedule (two instruments each year) at the National Renewable Energy Laboratory (NREL) in Golden, Colorado. NREL reference standards are calibrated to the World Radiometric Reference (WRR) in Davos, Switzerland.

DEPLOYMENT AND INSTALLATION

Mount the sensor to a solid surface with the nylon mounting screw provided. The included thermally-insulated base needs to be mounted between the sensor and the surface to which it is being mounted. To accurately measure total shortwave radiation incident on a horizontal surface, the sensor must be level. An Apogee Instruments model AL-100 Leveling Plate is recommended to level the sensor when used on a flat surface or being mounted to surfaces such as wood. To facilitate mounting on a mast or pipe, the Apogee Instruments model AL-120 Solar Mounting Bracket with Leveling Plate is recommended.

Important: Only use the nylon screw provided when mounting to insulate the non-anodized threads of the aluminum sensor head from the base to help prevent galvanic corrosion. For extended submersion applications, more insulation may be necessary. Contact Apogee tech support for details.



Thermally-insulated Base



Nylon Screw: 10-32x3/8



Model AL-100



Thermally-insulated Base



Nylon Screw: 10-32x3/8

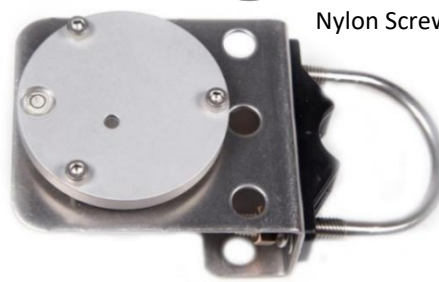

Model AL-120

To minimize azimuth error, the sensor should be mounted with the cable pointing toward true north in the northern hemisphere or true south in the southern hemisphere. Azimuth error is typically less than 1 %, but it is easy to minimize by proper cable orientation.

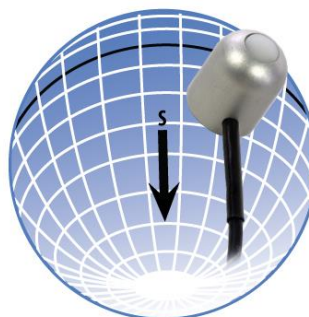
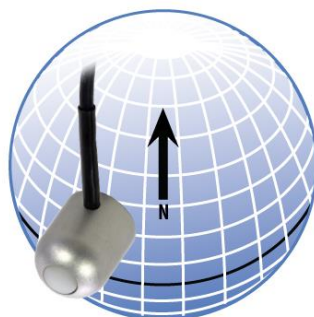

In addition to orienting the cable to point toward the nearest pole, the sensor should also be mounted such that obstructions (e.g., weather station tripod/tower or other instrumentation) do not shade the sensor. **Once mounted, the green cap should be removed from the sensor.** The green cap can be used as a protective covering for the sensor when it is not in use.

CABLE CONNECTORS

Apogee started offering in-line cable connectors on some bare-lead sensors in March 2018 to simplify the process of removing sensors from weather stations for calibration (the entire cable does **not** have to be removed from the station and shipped with the sensor).

The ruggedized M8 connectors are rated IP68, made of corrosion-resistant marine-grade stainless-steel, and designed for extended use in harsh environmental conditions.

Instructions

Pins and Wiring Colors: All Apogee connectors have six pins, but not all pins are used for every sensor. There may also be unused wire colors inside the cable. To simplify datalogger connection, we remove the unused pigtail lead colors at the datalogger end of the cable.

If a replacement cable is required, please contact Apogee directly to ensure ordering the proper pigtail configuration.

Alignment: When reconnecting a sensor, arrows on the connector jacket and an aligning notch ensure proper orientation.

Disconnection for extended periods: When disconnecting the sensor for an extended period of time from a station, protect the remaining half of the connector still on the station from water and dirt with electrical tape or other method.

Tightening: Connectors are designed to be firmly finger-tightened only. There is an o-ring inside the connector that can be overly compressed if a wrench is used. Pay attention to thread alignment to avoid cross-threading. When fully tightened, 1-2 threads may still be visible.

***NOTE:** To avoid damaging the pins inside the connector, finger-tighten the connector by only turning the **metal** nut. Do **not** tighten by turning the black cable.



In-line cable connectors are installed 30 cm from the head



A reference notch inside the connector ensures proper alignment before tightening.



When sending sensors in for calibration, only send the short end of the cable and half the connector.



Finger-tighten firmly

OPERATION AND MEASUREMENT

Connect the sensor to a measurement device (meter, datalogger, controller) capable of measuring and displaying or recording a millivolt (mV) signal (an input measurement range of approximately 80 mV is required to cover the entire range of total shortwave radiation from the sun). In order to maximize measurement resolution and signal-to-noise ratio, the input range of the measurement device should closely match the output range of the pyranometer. **DO NOT connect the thermopile (white and black wires) to a power source. The detector is self-powered and applying voltage will damage it.**

VERY IMPORTANT: Apogee changed the wiring colors of all our bare-lead sensors in March 2018 in conjunction with the release of inline cable connectors on some sensors. To ensure proper connection to your data device, please note your serial number or if your sensor has a stainless-steel connector 30 cm from the sensor head then use the appropriate wiring configuration listed below. With the switch to connectors, we also changed to using cables that only have 4 or 7 internal wires. To make our various sensors easier to connect to your device, we clip off any unused wire colors at the end of the cable depending on the sensor. If you cut the cable or modify the original pigtail, you may find wires inside that are not used with your particular sensor. In this case, please disregard the extra wires and follow the color-coded wiring guide provided.

Wiring for SP-510 with Serial Numbers range 1270 and above, and SP-610 with Serial Numbers 1094 and above (or that have cable connectors)

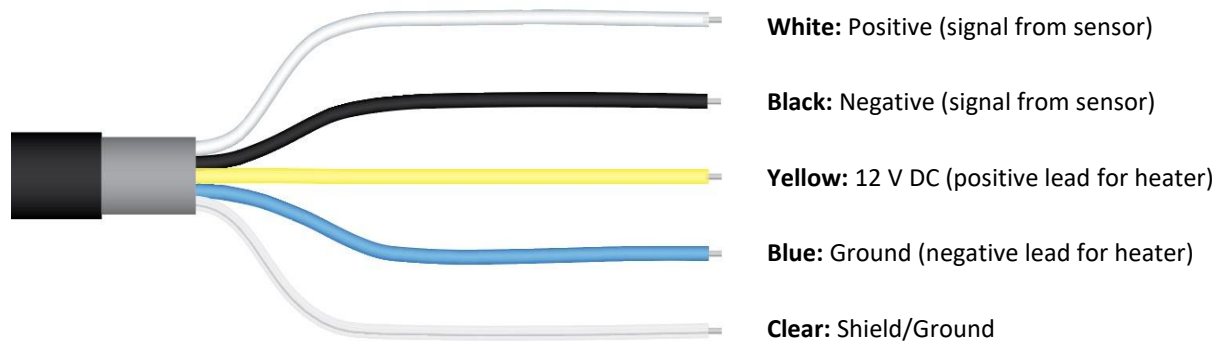

Wiring for SP-510 with Serial Numbers range 0-1269 and SP-610 with Serial Numbers range 0-1093

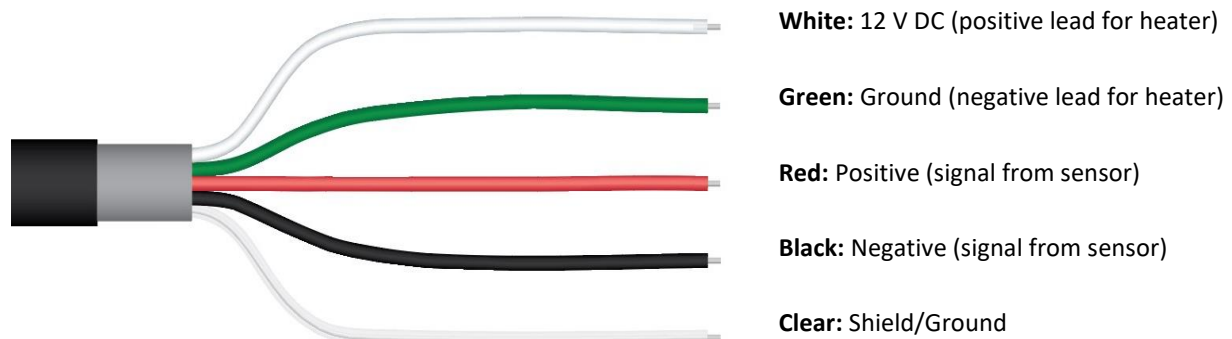

Sensor Calibration

Apogee model SP-510 and SP-610 pyranometers have calibration factors of approximately (calibration factor varies from sensor to sensor):

28.5 W m⁻² per mV (SP-510/610)

Multiply this calibration factor by the measured mV signal to convert sensor output to shortwave radiation in units of W m⁻²:

Calibration Factor (W m⁻² per mV) * Sensor Output Signal (mV) = Total Shortwave Radiation (W m⁻²)

$$28.5 \quad * \quad 35 \quad = \quad 1000$$

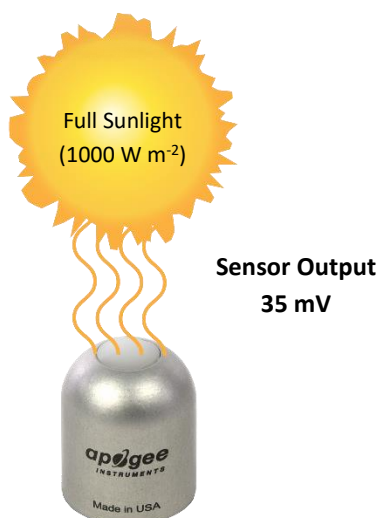

Example of total shortwave radiation measurement with an Apogee SP-510 pyranometer. Full sunlight yields total shortwave radiation on a horizontal plane at the Earth's surface of approximately 1000 W m⁻². This yields an output signal of 35 mV (varies from sensor to sensor). The signal is converted to shortwave radiation by multiplying by the calibration factor of 28.5 W m⁻² per mV (approximately, varies from sensor to sensor).

Operation of Heater

Apogee SP-510 and SP-610 pyranometers have an internal heater to allow for sensor heating during precipitation events or under conditions of dew and frost deposition. The heater is designed to keep the water (liquid and frozen) off the filter and does not need to be powered in order to make measurements of shortwave radiation. However, if the diffuser (SP-510) or glass window (SP-610) has water on the surface, errors can result. Continuously powering the heater under conditions that do not require heating will not damage the sensor or influence the measurements beyond what is reported in the specifications (thermal offset A changes when heaters are powered).

MAINTENANCE AND RECALIBRATION

Moisture or debris on the diffuser is a common cause of low readings. The sensor has a domed diffuser and housing for improved self-cleaning from rainfall, but materials can accumulate on the diffuser (e.g., dust during periods of low rainfall, salt deposits from evaporation of sea spray or sprinkler irrigation water) and partially block the optical path. Dust or organic deposits are best removed using water or window cleaner and a soft cloth or cotton swab. Salt deposits should be dissolved with vinegar and removed with a soft cloth or cotton swab. **Never use an abrasive material or cleaner on the diffuser.**

Although Apogee sensors are very stable, nominal accuracy drift is normal for all research-grade sensors. To ensure maximum accuracy, we generally recommend sensors are sent in for recalibration every two years, although you can often wait longer according to your particular tolerances.

To determine if your sensor needs recalibration, the Clear Sky Calculator (www.clearskycalculator.com) website and/or smartphone app can be used to indicate the total shortwave radiation incident on a horizontal surface at any time of day at any location in the world. It is most accurate when used near solar noon in spring and summer months, where accuracy over multiple clear and unpolluted days is estimated to be $\pm 4\%$ in all climates and locations around the world. For best accuracy, the sky must be completely clear, as reflected radiation from clouds causes incoming radiation to increase above the value predicted by the clear sky calculator. Measured values of total shortwave radiation can exceed values predicted by the Clear Sky Calculator due to reflection from thin, high clouds and edges of clouds, which enhances incoming shortwave radiation. The influence of high clouds typically shows up as spikes above clear sky values, not a constant offset greater than clear sky values.

To determine recalibration need, input site conditions into the calculator and compare total shortwave radiation measurements to calculated values for a clear sky. If sensor shortwave radiation measurements over multiple days near solar noon are consistently different than calculated values (by more than 6%), the sensor should be cleaned and re-leveled. If measurements are still different after a second test, email calibration@apogeeinstruments.com to discuss test results and possible return of sensor(s).



This calculator determines the intensity of radiation falling on a horizontal surface at any time of the day in any location in the world. The primary use of this calculator is to determine the need for recalibration of radiation sensors. It is most accurate when used near solar noon in the summer months.

This site developed and maintained by: **apogee** INSTRUMENTS

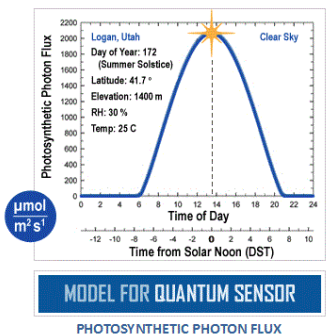
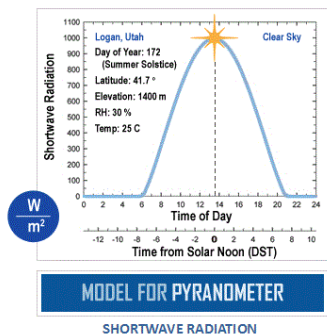

Homepage of the Clear Sky Calculator. Two calculators are available: One for pyranometers (total shortwave radiation) and one for quantum sensors (photosynthetic photon flux density).



FOR QUANTUM SENSORS

Input Parameters for Estimating Photosynthetic Photon Flux (PPF):

Output from Model:

- For best accuracy, comparison should be made on clear, non-polluted, summer days within one hour of solar noon.
- Enter input parameters in the blue cells at right. Definitions are shown below.
- Sensor must be level and perfectly clean. Enter your measured solar radiation in the blue "Measured PPF" cell at far right.
- Difference between the model and your sensor is shown in the yellow "DIFFERENCE FROM MODEL" cell at right.
- Run the model on replicate days. Contact Apogee for recalibration if the measured value is more than 5 % different than the estimated value. You will be contacted within two business days.

For a discussion on model accuracy and sensitivity of input parameters, [CLICK HERE](#).

Latitude =

Longitude =

Longitude_{tz} =

Elevation = m

Day of Year =

Time of Day = (6 min = 0.1 hr)

Daylight Savings = + hr

Air Temperature = C

Relative Humidity = %

RECALCULATE MODEL

Model Estimated PPF = **1994** $\mu\text{mol m}^{-2} \text{s}^{-1}$

Measured PPF = $\mu\text{mol m}^{-2} \text{s}^{-1}$

DIFFERENCE FROM MODEL = **-0.2** %

+ CONTACT APOGEE FOR RECALIBRATION

Name:

E-mail:

Phone:

Serial #:

Comments:

Please include all requested information.

SEND INFO TO APOGEE

INPUT AND OUTPUT DEFINITIONS

Latitude = latitude of the measurement site [degrees]; for southern hemisphere, insert as a negative number; info may be obtained from <http://touchmap.com/latlong.html>

Longitude = longitude of the measurement site [degrees]; expressed as positive degrees west of the standard meridian in Greenwich, England (e.g. 74° for New York, 260° for Bangkok, Thailand, and 358° for Paris, France).

Longitude_{tz} = longitude of the center of your local time zone [degrees]; expressed as positive degrees

This site is developed and maintained by: **apogee** INSTRUMENTS
calibration@apogee-inst.com

Clear Sky Calculator for pyranometers. Site data are input in blue cells in middle of page and an estimate of total shortwave radiation is returned on right-hand side of page.

TROUBLESHOOTING AND CUSTOMER SUPPORT

Independent Verification of Functionality

Apogee model SP-510 and SP-610 pyranometers are self-powered devices and output a voltage signal proportional to incident shortwave radiation. A quick and easy check of sensor functionality can be determined using a voltmeter with millivolt (mV) resolution. Connect the positive lead wire from the voltmeter to the white wire from the sensor and the negative (or common) lead wire from the voltmeter to the black wire from the sensor. Direct the sensor diffuser toward a light source and verify the sensor provides a signal. Increase and decrease the distance from the sensor head to the light source to verify that the signal changes proportionally (decreasing signal with increasing distance and increasing signal with decreasing distance). Blocking all radiation from the sensor should force the sensor signal to zero.

Compatible Measurement Devices (Dataloggers/Controllers/Meters)

Model SP-510 and SP-610 pyranometers have calibration factors of approximately 28.5 W m⁻² per mV. This yields sensitivities of approximately 0.035 mV per W m⁻². Thus, a compatible measurement device (e.g., datalogger or controller) should have resolution of at least 0.035 mV, in order to provide shortwave radiation resolution of 1 W m⁻².

An example datalogger program for Campbell Scientific dataloggers can be found on the Apogee webpage at <http://www.apogeeinstruments.com/content/Thermopile-Pyranometer-Unamplified.CR1>.

Effect of Cable Length

When the sensor is connected to a measurement device with high input impedance, sensor output signals are not changed by shortening the cable or splicing on additional cable in the field. Tests have shown that if the input impedance of the measurements device is one mega-ohm or higher then there is negligible effect on the pyranometer calibration, even after adding up to 100 m of cable. Apogee model SP series pyranometers use shielded, twisted pair cable, which minimizes electromagnetic interference. This is particularly important for long lead lengths in electromagnetically noisy environments.

Modifying Cable Length

See Apogee webpage for details on how to extend sensor cable length (<http://www.apogeeinstruments.com/how-to-make-a-weatherproof-cable-splice/>).

RETURN AND WARRANTY POLICY

RETURN POLICY

Apogee Instruments will accept returns within 30 days of purchase as long as the product is in new condition (to be determined by Apogee). Returns are subject to a 10 % restocking fee.

WARRANTY POLICY

What is Covered

All products manufactured by Apogee Instruments are warranted to be free from defects in materials and craftsmanship for a period of four (4) years from the date of shipment from our factory. To be considered for warranty coverage an item must be evaluated by Apogee.

Products not manufactured by Apogee (spectroradiometers, chlorophyll content meters, EE08-SS probes) are covered for a period of one (1) year.

What is Not Covered

The customer is responsible for all costs associated with the removal, reinstallation, and shipping of suspected warranty items to our factory.

The warranty does not cover equipment that has been damaged due to the following conditions:

1. Improper installation, use, or abuse.
2. Operation of the instrument outside of its specified operating range.
3. Natural occurrences such as lightning, fire, etc.
4. Unauthorized modification.
5. Improper or unauthorized repair.

Please note that nominal accuracy drift is normal over time. Routine recalibration of sensors/meters is considered part of proper maintenance and is not covered under warranty.

Who is Covered

This warranty covers the original purchaser of the product or other party who may own it during the warranty period.

What Apogee Will Do

At no charge Apogee will:

1. Either repair or replace (at our discretion) the item under warranty.
2. Ship the item back to the customer by the carrier of our choice.

Different or expedited shipping methods will be at the customer's expense.

How To Return An Item

1. Please do not send any products back to Apogee Instruments until you have received a Return Merchandise Authorization (RMA) number from our technical support department by submitting an online RMA form at www.apogeeinstruments.com/tech-support-recalibration-repairs/. We will use your RMA number for tracking of the service item. Call (435) 245-8012 or email techsupport@apogeeinstruments.com with questions.
2. For warranty evaluations, send all RMA sensors and meters back in the following condition: Clean the sensor's exterior and cord. Do not modify the sensors or wires, including splicing, cutting wire leads, etc. If a connector has been attached to the cable end, please include the mating connector – otherwise the sensor connector will be removed in order to complete the repair/recalibration. **Note:** *When sending back sensors for routine calibration that have Apogee's standard stainless-steel connectors, you only need to send the sensor with the 30 cm section of cable and one-half of the connector. We have mating connectors at our factory that can be used for calibrating the sensor.*
3. Please write the RMA number on the outside of the shipping container.
4. Return the item with freight pre-paid and fully insured to our factory address shown below. We are not responsible for any costs associated with the transportation of products across international borders.

Apogee Instruments, Inc.
721 West 1800 North Logan, UT
84321, USA

5. Upon receipt, Apogee Instruments will determine the cause of failure. If the product is found to be defective in terms of operation to the published specifications due to a failure of product materials or craftsmanship, Apogee Instruments will repair or replace the items free of charge. If it is determined that your product is not covered under warranty, you will be informed and given an estimated repair/replacement cost.

PRODUCTS BEYOND THE WARRANTY PERIOD

For issues with sensors beyond the warranty period, please contact Apogee at techsupport@apogeeinstruments.com to discuss repair or replacement options.

OTHER TERMS

The available remedy of defects under this warranty is for the repair or replacement of the original product, and Apogee Instruments is not responsible for any direct, indirect, incidental, or consequential damages, including but not limited to loss of income, loss of revenue, loss of profit, loss of data, loss of wages, loss of time, loss of sales, accrual of debts or expenses, injury to personal property, or injury to any person or any other type of damage or loss.

This limited warranty and any disputes arising out of or in connection with this limited warranty ("Disputes") shall be governed by the laws of the State of Utah, USA, excluding conflicts of law principles and excluding the Convention for the International Sale of Goods. The courts located in the State of Utah, USA, shall have exclusive jurisdiction over any Disputes.

This limited warranty gives you specific legal rights, and you may also have other rights, which vary from state to state and jurisdiction to jurisdiction, and which shall not be affected by this limited warranty. This warranty extends only to you and cannot be transferred or assigned. If any provision of this limited warranty is unlawful, void, or unenforceable, that provision shall be deemed severable and shall not affect any remaining provisions. In case of any inconsistency between the English and other versions of this limited warranty, the English version shall prevail.

This warranty cannot be changed, assumed, or amended by any other person or agreement

APOGEE INSTRUMENTS, INC. | 721 WEST 1800 NORTH, LOGAN, UTAH 84321, USA
TEL: (435) 792-4700 | FAX: (435) 787-8268 | WEB: APOGEEINSTRUMENTS.COM