

- Low Noise: 10 $\mu\text{g}/\text{Hz}$ Typical for $\pm 2\text{g}$ Full Scale Versions
- -55 to +125°C Operating Temperature Range
- Acceleration and Vibration Sensing
- Excellent Long-Term Stability
- +5 VDC Power for Low Voltage Power Supply Systems
- $\pm 4\text{V}$ Differential Output or 0.5V to 4.5V Single Ended Output
- Responds to frequencies from zero (DC) to 2000+ Hz
- Simple Eight (8) Wire Connection
- Rugged, Hermetic Titanium Case Capable of IP67
- Fully Calibrated and Serialized for Traceability

AVAILABLE G-RANGES	
FULL SCALE ACCELERATION	MODEL SUFFIX
$\pm 2\text{ g}$	-002
$\pm 5\text{ g}$	-005
$\pm 10\text{ g}$	-010
$\pm 25\text{ g}$	-025
$\pm 50\text{ g}$	-050
$\pm 100\text{ g}$	-100
$\pm 200\text{ g}$	-200
$\pm 400\text{ g}$	-400

PREMIUM, LOW VOLTAGE, HERMETIC +5V DC 3-AXIS ACCELEROMETER

The Model 2422H Specialty Hermetic MEMS DC Accelerometer from Silicon Designs (SDI) is low-cost, integrated plug-and-play measurement device suitable for a wide array of demanding applications. The 2422H provides enhanced performance over temperature in zero to medium frequency applications experiencing large or rapid temperature variations or maintaining hot or cold extremes for extended periods of time.



The SDI Model 2422H contains three orthogonally mounted, premium accelerometer LCCs, making them even less sensitive to temperature changes and gradients from -55 to +125°C and greatly reducing bias and scale factor temperature shifts for premium performance. Their enhanced, temperature compensated, proprietary SDI Model 1522 accelerometer LCC chips are individually tested, calibrated and verified in a climate chamber. The 2422H comes with an initial calibration report featuring additional information about the linearity, output, phase, and frequency response as tested for each unit.

SDI Model 2422H accelerometers are packaged in rugged, hermetically-sealed, titanium cases, and connectors allow for customized cable lengths and easy repositioning. The cases are rated IP67; the connector is rated IP61 and can meet IP67 when sealed with a boot, sleeve, or heat shrink. The case is easily mounted via two screws, adhesive, or by attaching a magnet.

ZERO (DC) TO MEDIUM FREQUENCY APPLICATIONS



PERFORMANCE BY G RANGE

INPUT RANGE	SENSITIVITY, DIFFERENTIAL	FREQUENCY RESPONSE (TYPICAL, 5%)	FREQUENCY RESPONSE (TYPICAL, 3 DB)	FREQUENCY RESPONSE (MINIMUM, 3 DB)	OUTPUT NOISE, DIFFERENTIAL (RMS, TYPICAL)	MAX. MECHANICAL SHOCK (0.1 MS)
g	mV/g	Hz	Hz	Hz	$\mu\text{g}/(\text{root Hz})$	g (peak)
± 2	2000	0 - 250	0 - 525	0 - 300	10	2000
± 5	800	0 - 400	0 - 800	0 - 420	15	
± 10	400	0 - 700	0 - 1100	0 - 660	23	
± 25	160	0 - 1300	0 - 1750	0 - 1050	38	
± 50	80	0 - 1600	0 - 2100	0 - 1400	60	5000
± 100	40	0 - 1700	0 - 3000	0 - 1700	121	
± 200	20	0 - 1900	0 - 3600	0 - 2100	243	
± 400	10	0 - 2000	0 - 4200	0 - 2400	475	

By Version: $V_{DD}=V_{R}=5.0\text{ VDC}$, $T_C=25^\circ\text{C}$

Single ended sensitivity is half of values shown.

SPECIFICATIONS SUBJECT TO CHANGE WITHOUT NOTICE

PERFORMANCE - ALL VERSIONS

All Models: Unless otherwise specified, $V_s = +8$ to $+32$ VDC, $T_C = 25^\circ\text{C}$, Differential Mode. Span = $\pm g$ range = 8000 mV.

PARAMETER	MIN	TYP	MAX	UNITS
Bias Calibration Error (%)		0.25	0.6	\pm % of span
Bias Calibration Error (mV)		25	60	\pm mV
Scale Factor Calibration Error ¹		0.5	1.25	\pm %
Non-Linearity (-90 to +90% of span) ¹		0.15	0.5	\pm % of span
Bias Temperature Shift (Coefficient)	-100	0	+100	(PPM of span)/ $^\circ\text{C}$
Scale Factor Temperature Shift (Coefficient)	-150	0	+50	PPM/ $^\circ\text{C}$
Cross Axis Sensitivity		2	3	\pm %
Power Supply Rejection Ratio		25		dB
Output Impedance		1		Ω
Output Common Mode Voltage		2.5		VDC
Operating Voltage	4.75	5	5.25	VDC
Operating Current (AOP & AON open)		21	30	mA DC
Mass		24		grams
Operating Temperature	-55		+125	$^\circ\text{C}$

Note 1: For 2g thru 50g only; 100g and greater versions are tested and specified from -65 to $+65g$.

NOTICE: Stresses greater than those listed may cause permanent damage to the device. These are maximum stress ratings only. Functional operation of the device at or above these conditions is not implied.

BIAS & SCALE FACTOR TEMPERATURE SHIFT EXPLAINED

Every accelerometer has a bias and scale factor temperature coefficient, meaning the output shifts slightly due to temperature changes. Many applications operate within a relatively small temperature band or at room temperature, and therefore rarely encounter interference from the bias or scale factor temperature shifts. These customers are ideal candidates for SDI's Low-Cost accelerometer modules.

For applications experiencing larger temperature variations (i.e. exposure to engine temperatures or arctic testing) SDI suggests the upgraded Premium accelerometer modules. These have enhanced, temperature compensated, proprietary SDI Model 1522 accelerometer chips, which are individually tested, calibrated and verified in a climate chamber to provide the most accuracy and come with an initial calibration certificate.

Bias	The accelerometer output with no acceleration present. For SDI's differential output analog accelerometers, it is a signed quantity that is expressed in terms of either g or output volts and is ideally equal to zero g or zero volts.
Scale Factor	The ratio of the change in output to a unit change in the input acceleration expressed in millivolts per g (mV/g). Since the output of most accelerometers is slightly non-linear, the scale factor value is defined as the slope of the least-squares-fit line to the acceleration input vs output curve. SDI measures over the range of -90% to +90% of full scale or from -65g to +65g, whichever is smaller.
Bias Temperature Shift (Coefficient)	The amount of bias shift to expect with a change in temperature expressed as PPM of span per $^\circ\text{C}$. For example, the percent of span bias shift that would occur for a 25g full scale device with a ± 200 PPM of span per $^\circ\text{C}$ rating and a 55°C rise from room temperature would be: $\pm 200 / 1,000,000 \times (80^\circ\text{C} - 25^\circ\text{C}) \times 100\%$ of span = $\pm 1.1\%$ of span. The g shift would be $\pm 1.1\%$ of 50g = 0.55 g. This error in terms of output voltage for a 25 g analog accelerometer would be $\pm 1.1\%$ of span = $\pm 1.1\%$ of 8 V = 88 mV.
Scale Factor Temperature Shift (Coefficient)	The amount of scale factor shift to expect with a change in temperature expressed as PPM per $^\circ\text{C}$. For example, the percent shift in scale factor that would occur for a device with a +200 PPM per $^\circ\text{C}$ rating and a 60°C rise from room temperature would be: $200 / 1,000,000 \times (85^\circ\text{C} - 25^\circ\text{C}) \times 100\%$ = +1.2%. For an analog 10g device, the scale factor would rise from its nominal (8 V)/(20 g) = 400 mV/g at +25C to 400 mV/g + 1.2% = 404.8 mV/g.

SPECIFICATIONS SUBJECT TO CHANGE WITHOUT NOTICE

OPERATION

SDI Model 2422H Specialty +5 VDC Hermetic MEMS DC Accelerometers provide optimal performance when they are connected to instrumentation in a differential configuration using both the AOP and AON output signals, but they also support single ended operation for complete flexibility.

These accelerometers produce differential analog output voltage pairs (AON & AOP) which vary with acceleration. The signal outputs are fully differential about a common mode voltage of approximately 2.5 volts. At zero acceleration, the output differential voltage is nominally 0 volts DC; at \pm full scale acceleration, the output is ± 4 volts DC, respectively, as shown in the figure (below). The output scale factor is independent from the supply voltage of +8 to +32 volts.

When a differential connection is not possible, SDI recommends connecting the accelerometer to instrumentation in single ended mode by connecting AOP and GND to the instrumentation and leaving AON disconnected. Keep in mind that the signal to noise ratio is reduced by half for a single-ended vs. a differential connection.

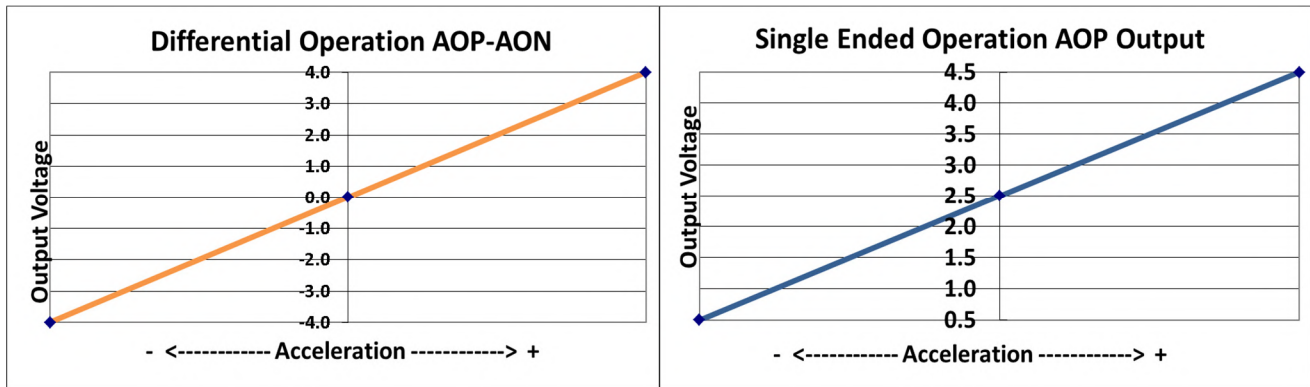

CABLE SPECIFICATIONS

The SDI Model 2422H has a 9-pin connector and only eight pins are used for the 8-wire cable; the 8PIN-CAB cable consists of eight 26 AWG tin-plated copper wires. All eight of the 26 AWG wires are covered by 8.5 mils of Teflon insulation.

Cables are available in five standard lengths, and custom lengths may be available for special order.

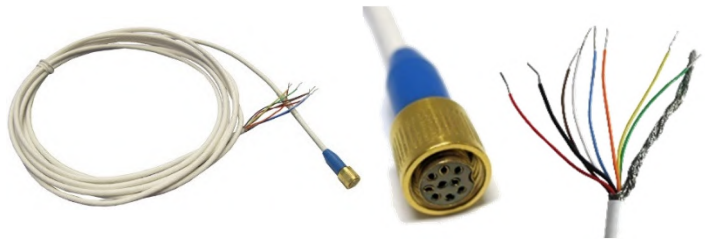

CABLE LENGTH CONSIDERATIONS

The 8PIN-CAB is available in five (5) standard lengths. Custom lengths may be available for special order. However, while it is possible to extend the cable length of the Model 2422H beyond 10 feet, it is not recommended due to the limited voltage.

NAME	LENGTH - FEET	LENGTH - METERS (APPROXIMATE)
8PIN-CAB-04	4 feet	1.2 Meters
8PIN-CAB-10	10 feet	3 Meters

RECOMMENDED CONNECTIONS - DIFFERENTIAL

SDI Model 2422H is connected to instrumentation in a differential configuration using both the AOP and AON output signals.

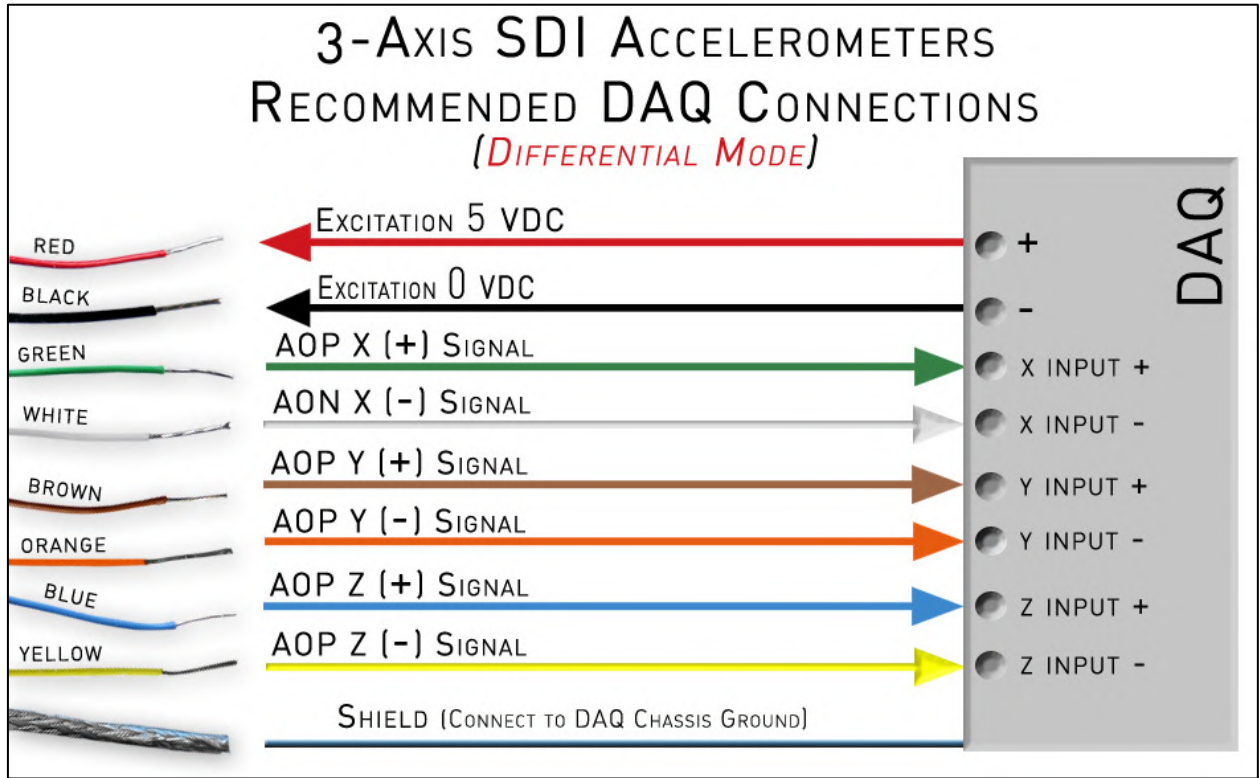
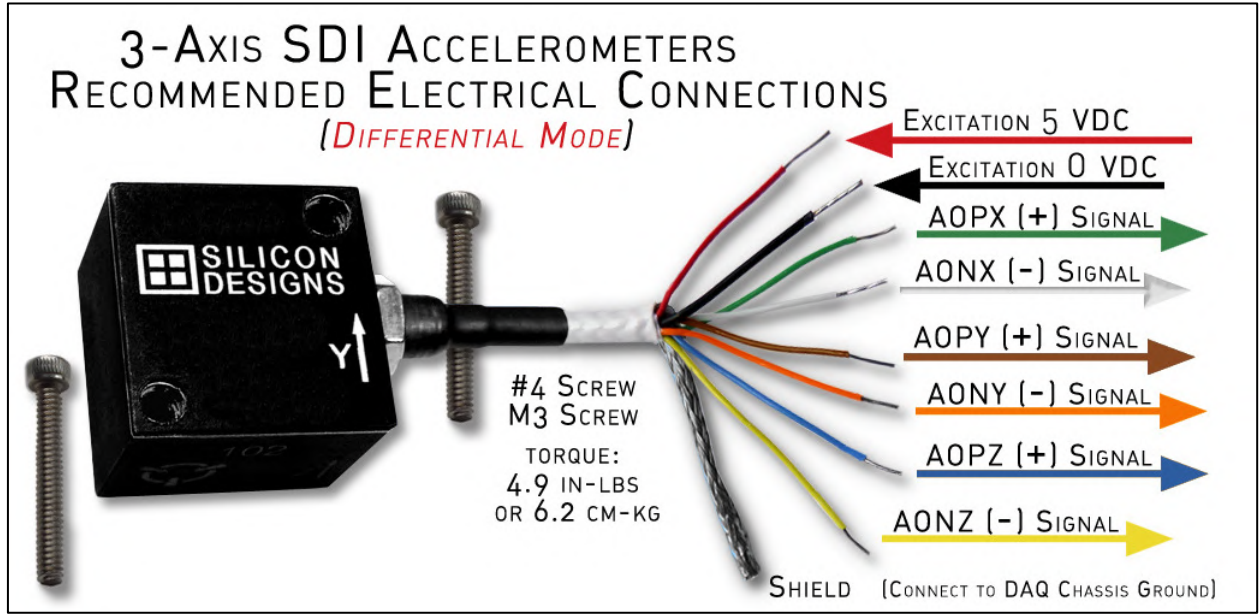

RECOMMENDED CONNECTIONS – SINGLE ENDED

Single ended operation is also possible with minor changes to the wiring configuration, as described below.

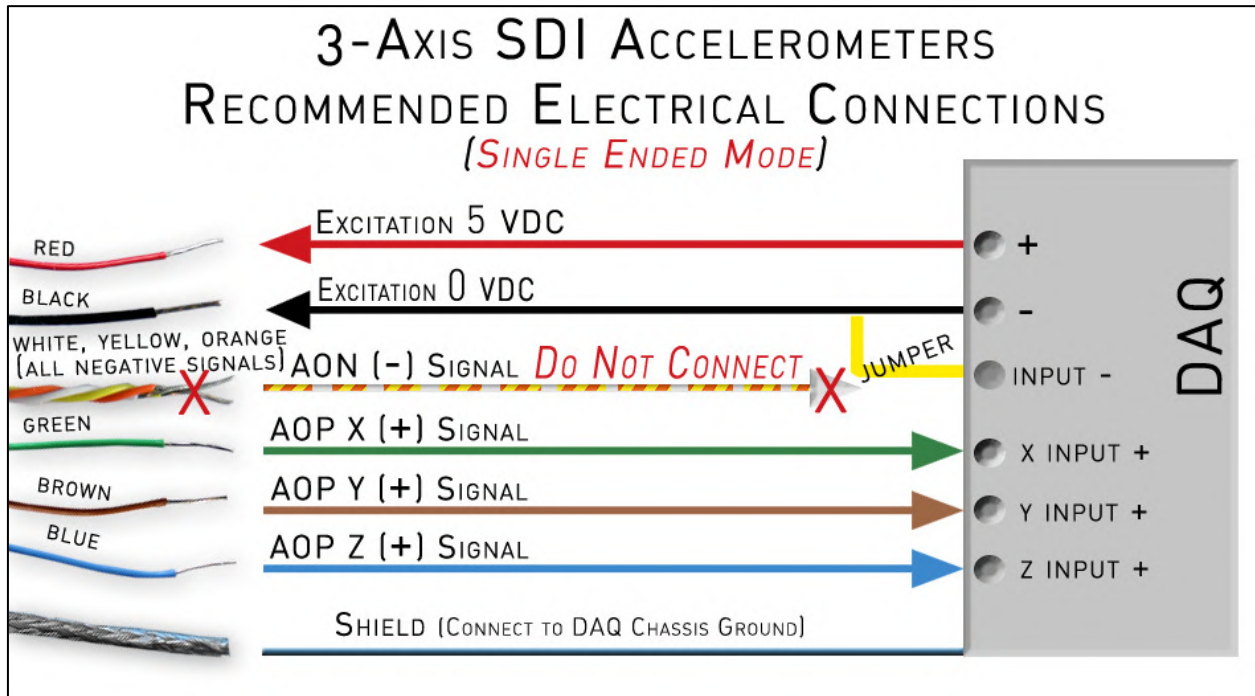
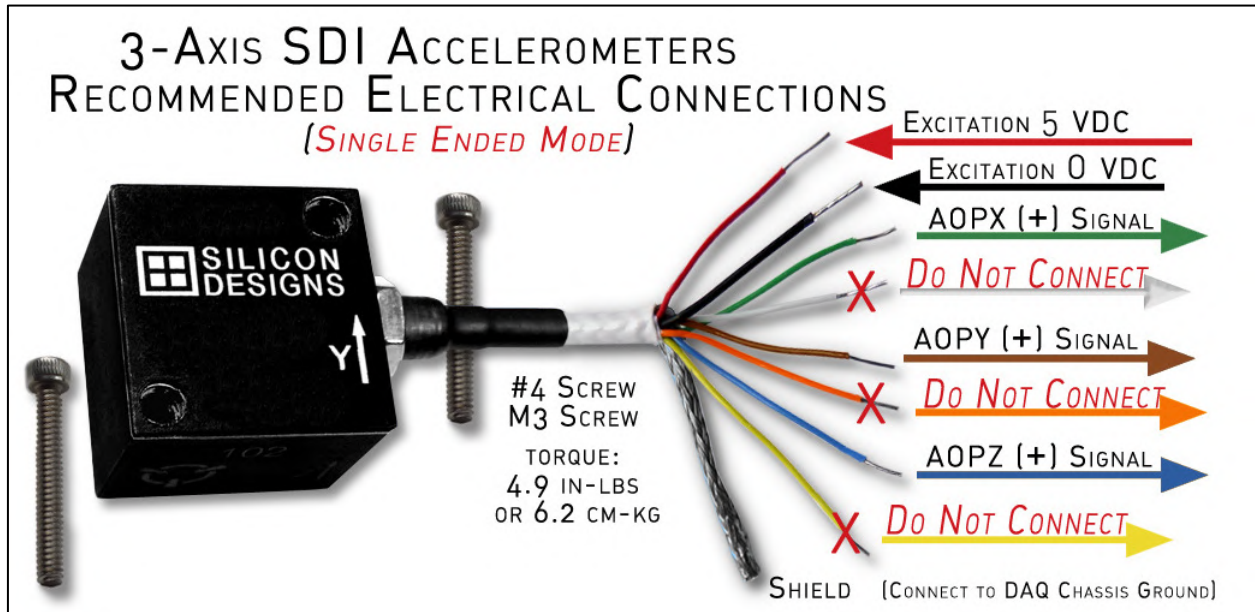

PACKAGE DIMENSIONS

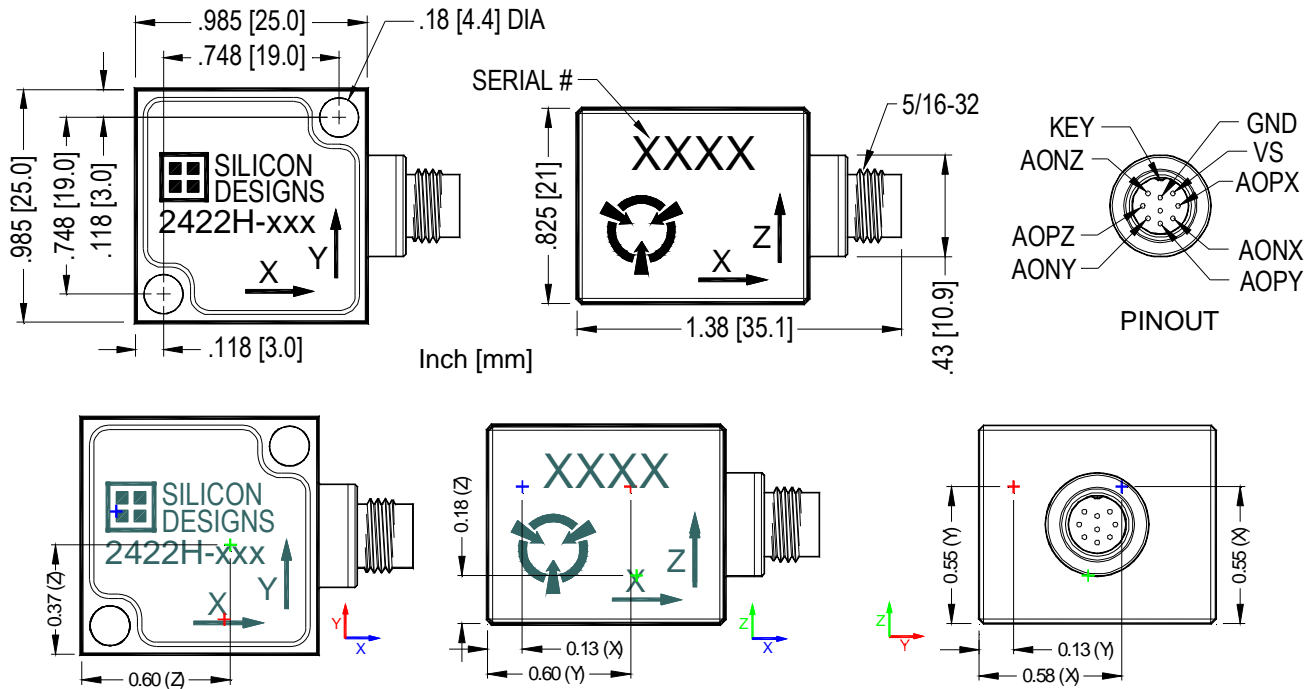

All measurements are in inches

COMPARABLE MODELS

SDI also produces premium 3-axis accelerometer models with power regulation and internal amplifiers for use with +8-32 V DC power supplies. Within these, customers can choose between an integrated 3' cable or an identical connector to that on the 2422H, allowing for interchangeable cables.

ALTERNATIVE MODEL

CHARACTERISTICS



- Anodized aluminum case
- LxWxH Dimensions: 1"x1"x 0.825"
- Integrated 3' cable with strain relief



- Anodized aluminum case
- LxWxH Dimensions: 1"x 1"x 0.825"
- Same connector as 2422H for interchangeable cables



- Hermetic, titanium case identical to 2422H
- LxWxH Dimensions: 1"x 1"x 0.825"
- Same connector as 2422H for interchangeable cables

SPECIFICATIONS SUBJECT TO CHANGE WITHOUT NOTICE

**CALIBRATION REPORT EXAMPLES
LINEARITY, PHASE & FREQUENCY RESPONSE BY G-LEVEL**

The included calibration reports provide additional information about the linearity, output, phase, and frequency response as tested for each individual unit. The following are examples of the graphical data supplied on calibration reports, by G-level for the SDI Model 2422 Premium 3-axis accelerometer.

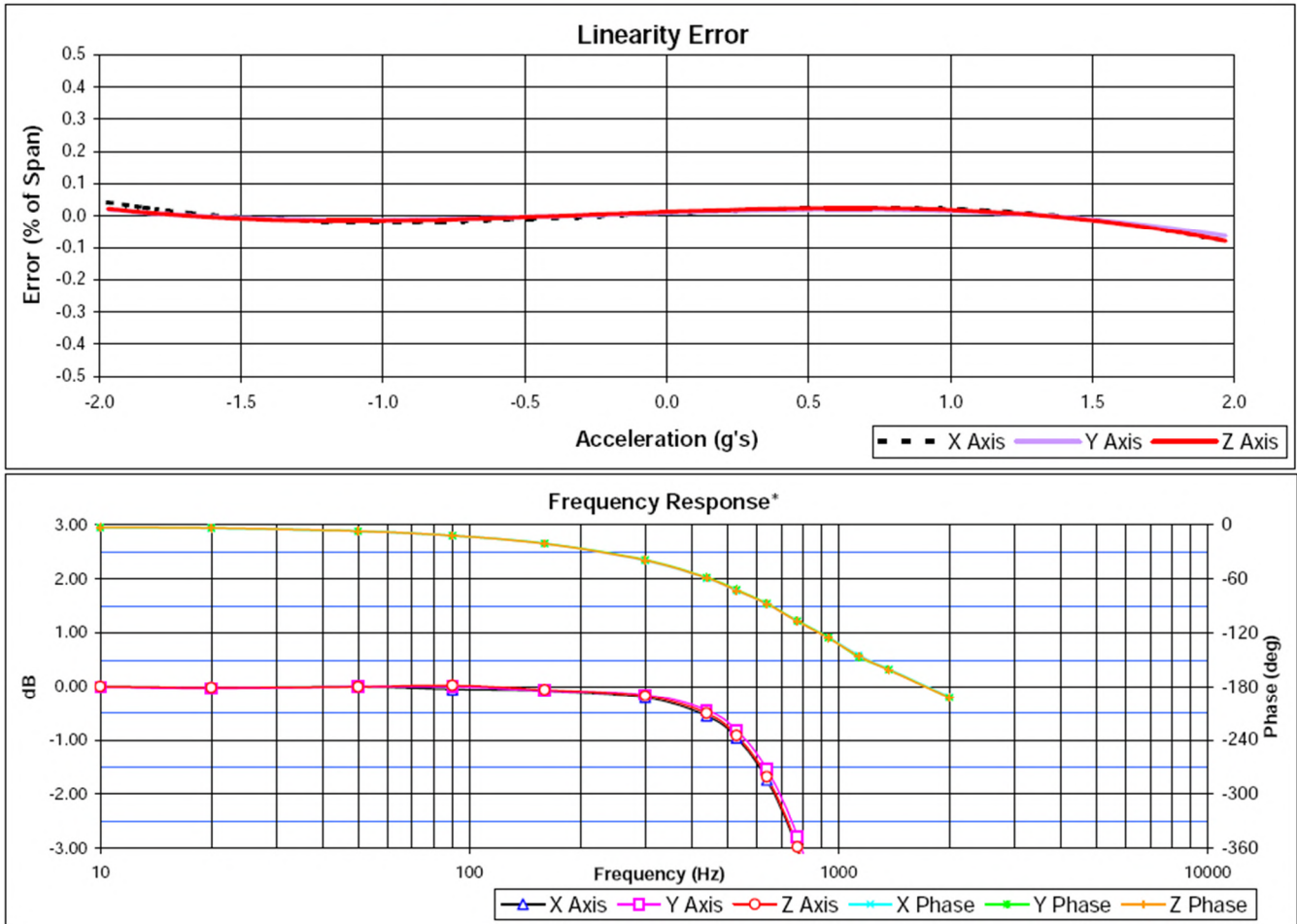
EXAMPLE 2G in 3-AXIS

EXAMPLE 5G in 3-AXIS

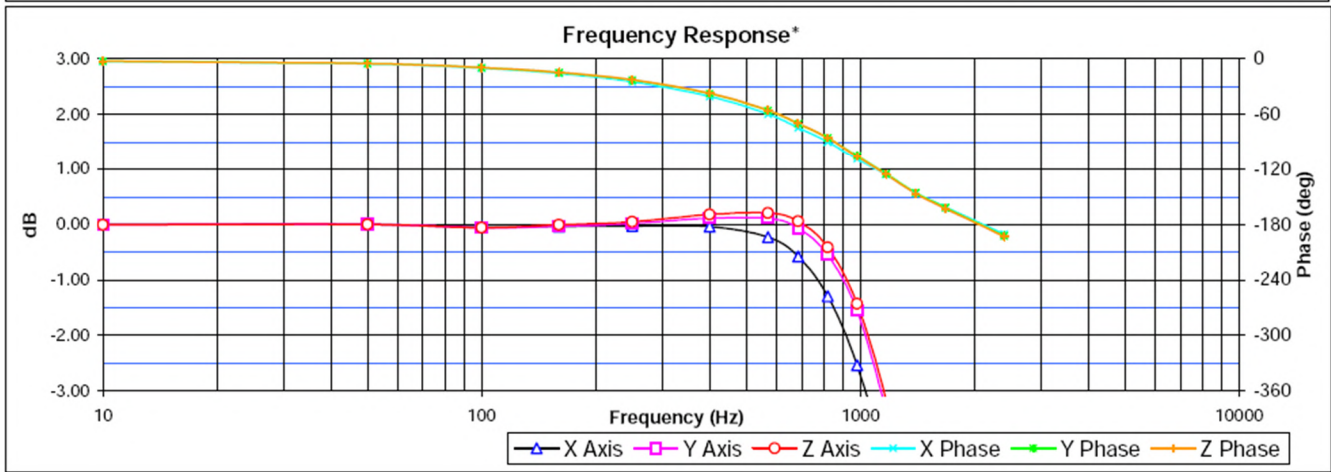
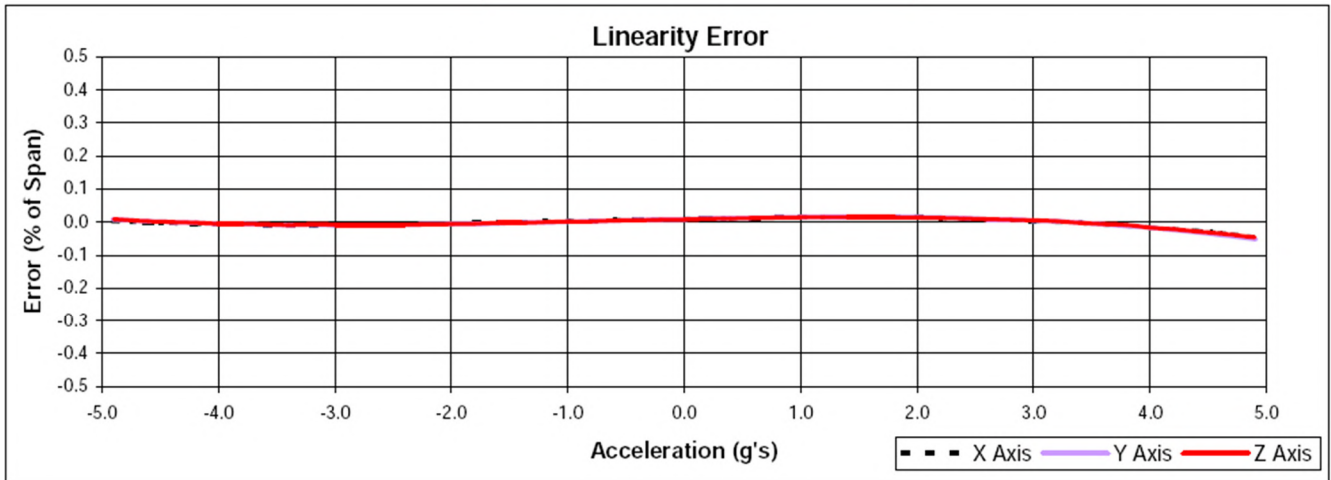

EXAMPLE 10G in 3-AXIS

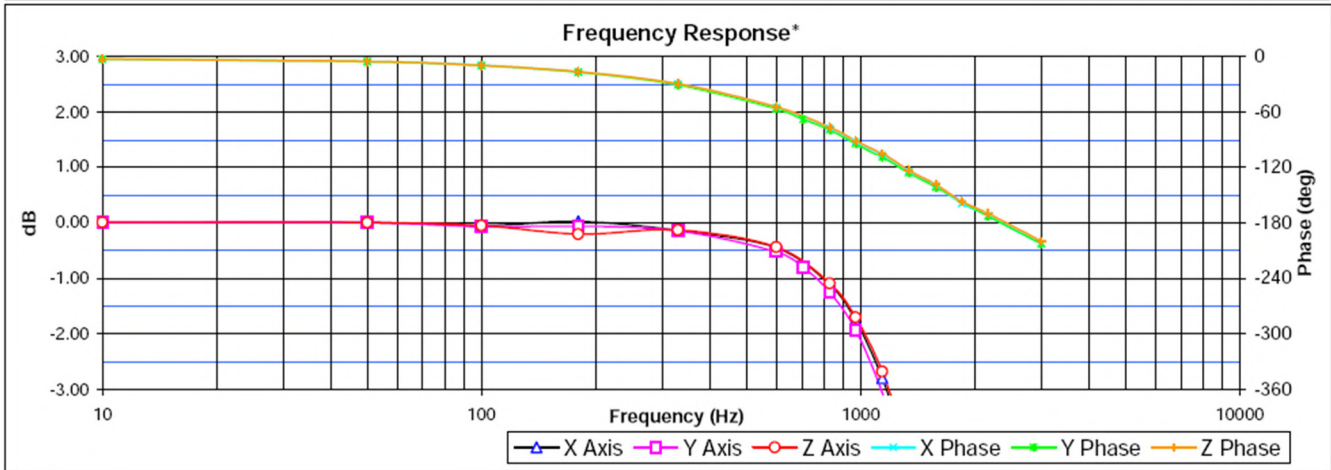
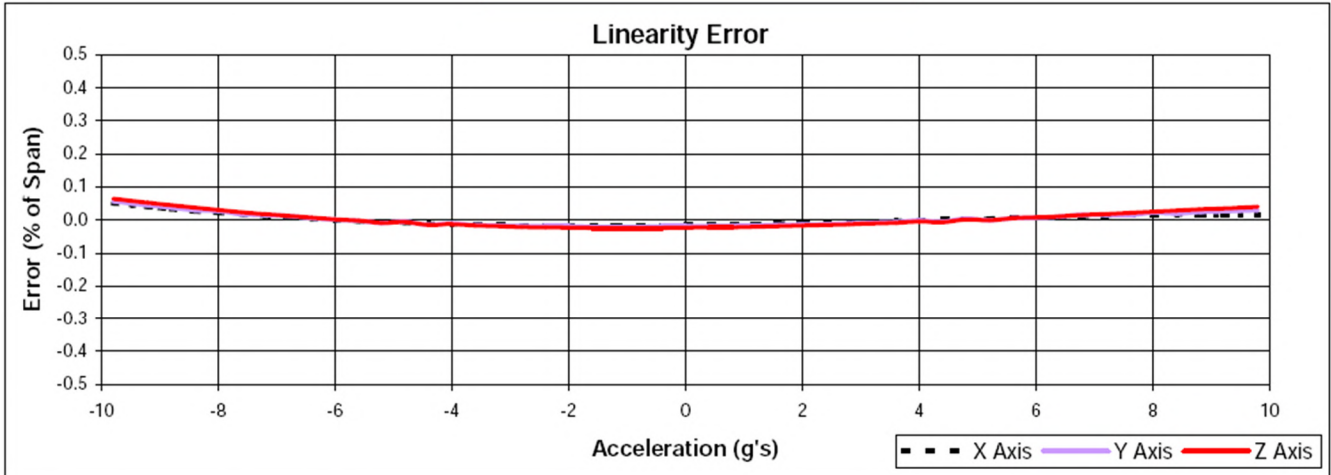

SPECIFICATIONS SUBJECT TO CHANGE WITHOUT NOTICE

EXAMPLE 25G in 3-AXIS

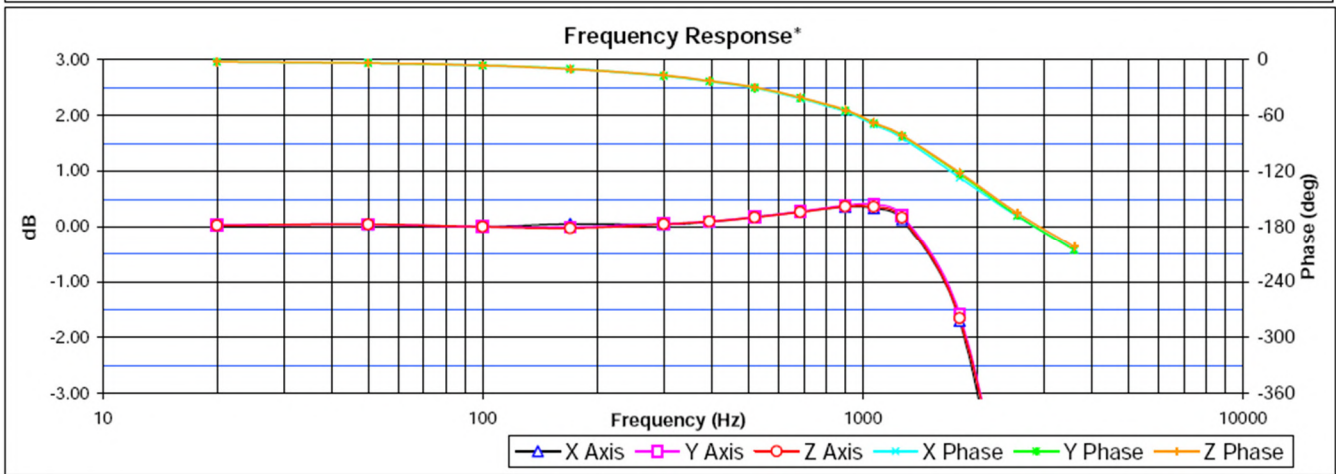
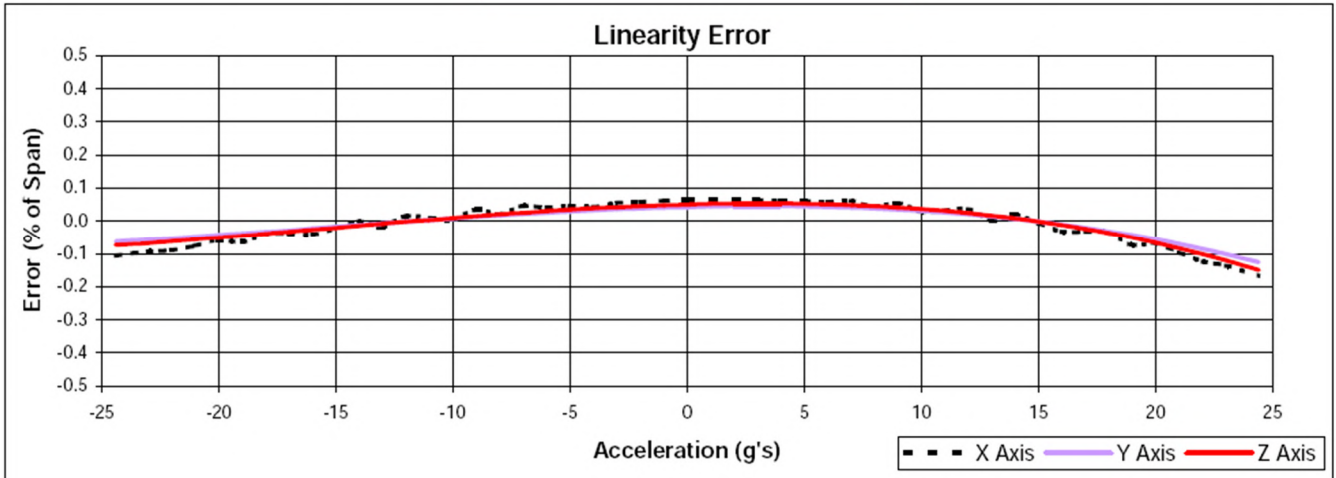

EXAMPLE 50G in 3-AXIS

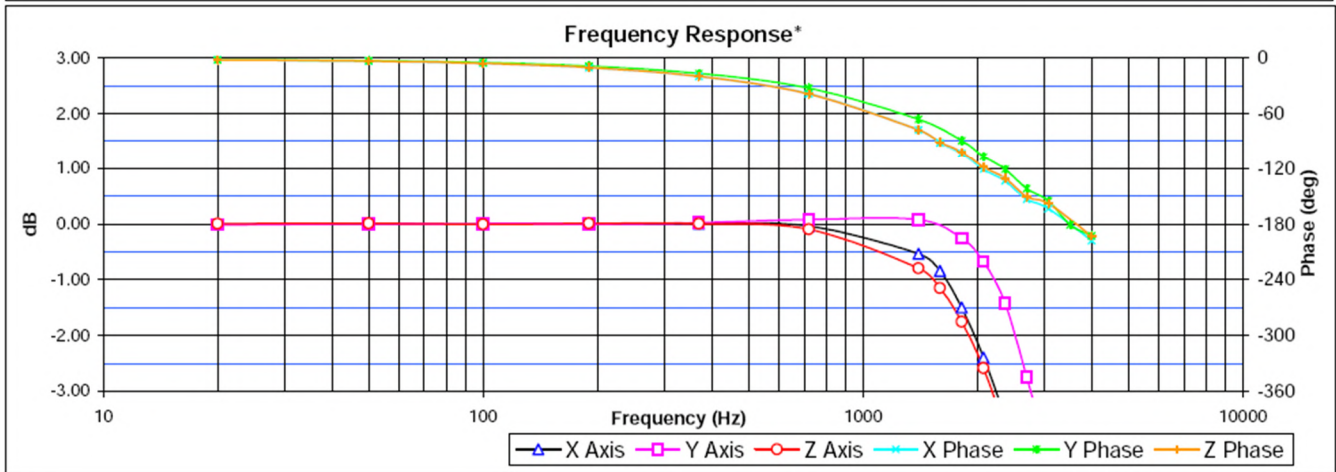
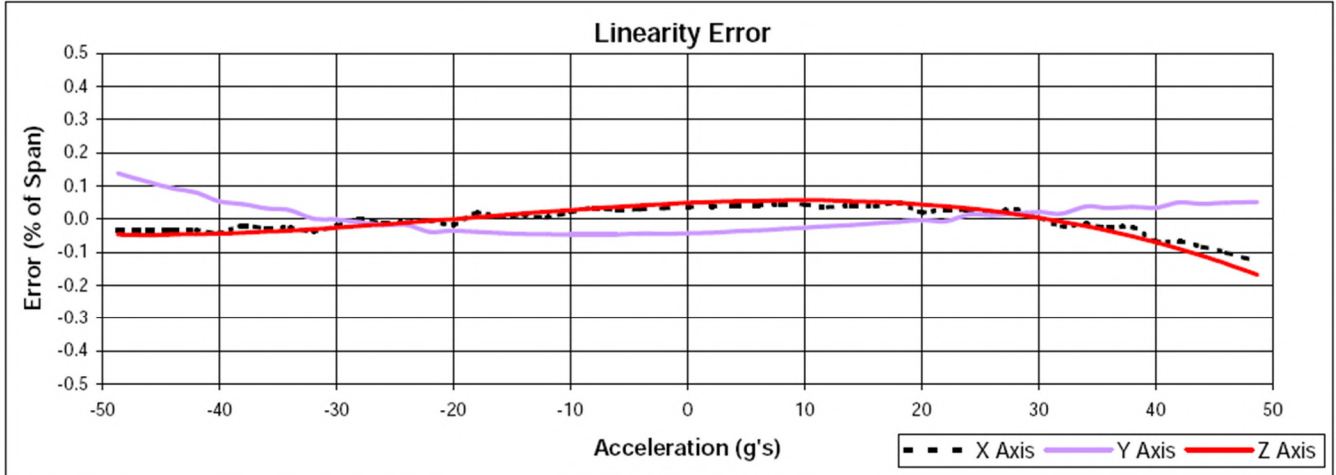

EXAMPLE 100G in 3-AXIS

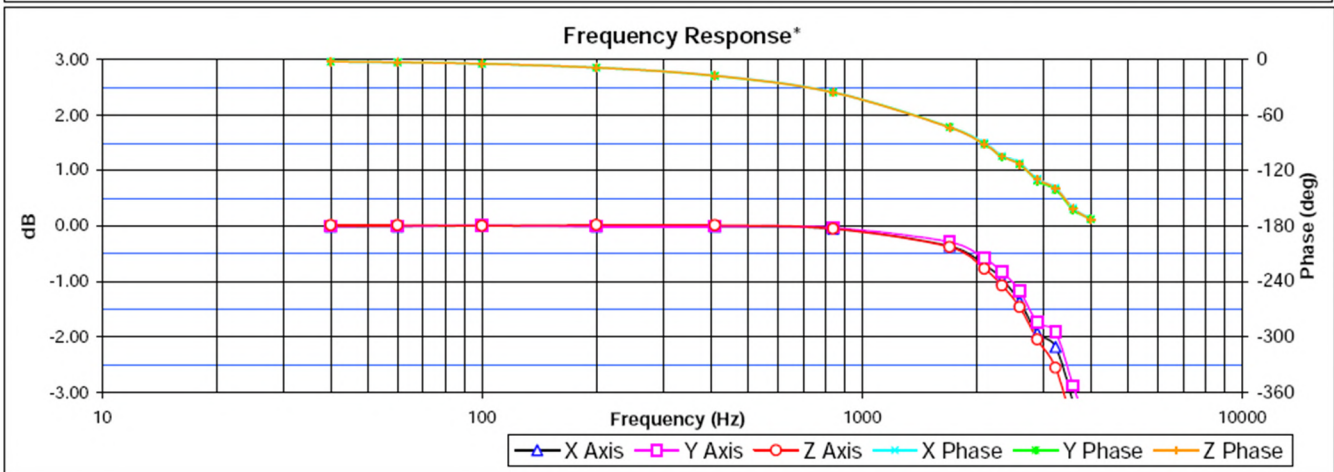
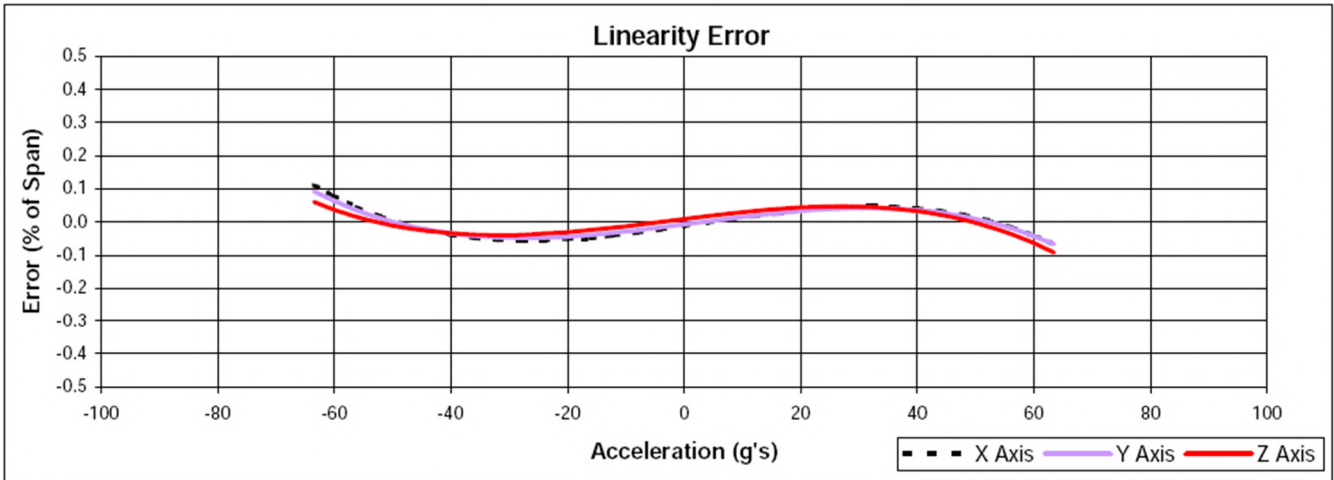

SPECIFICATIONS SUBJECT TO CHANGE WITHOUT NOTICE

EXAMPLE 200G in 3-AXIS

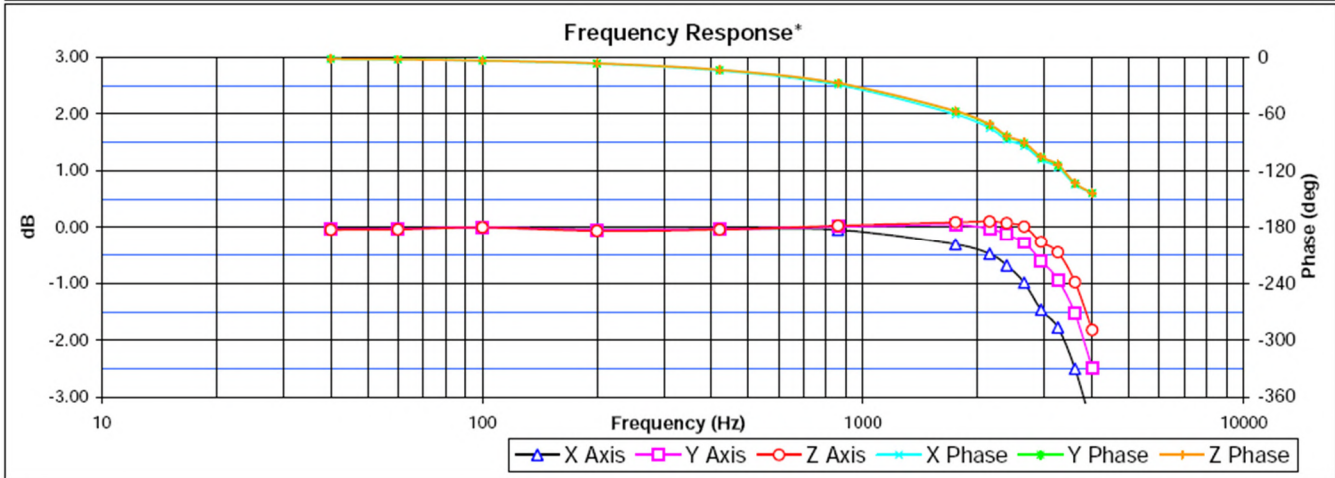
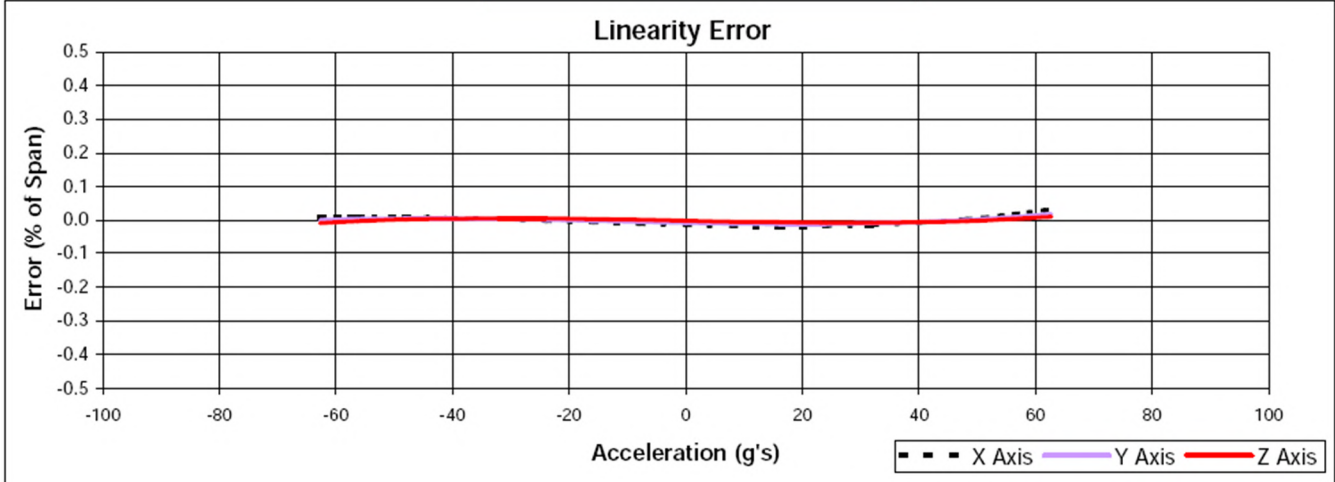

EXAMPLE 400G in 3-AXIS

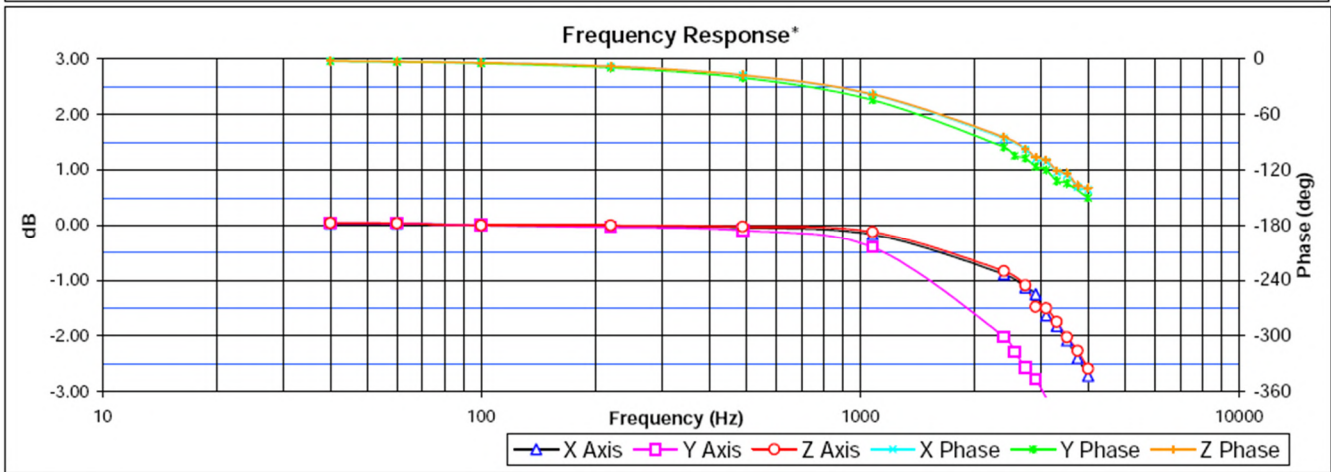
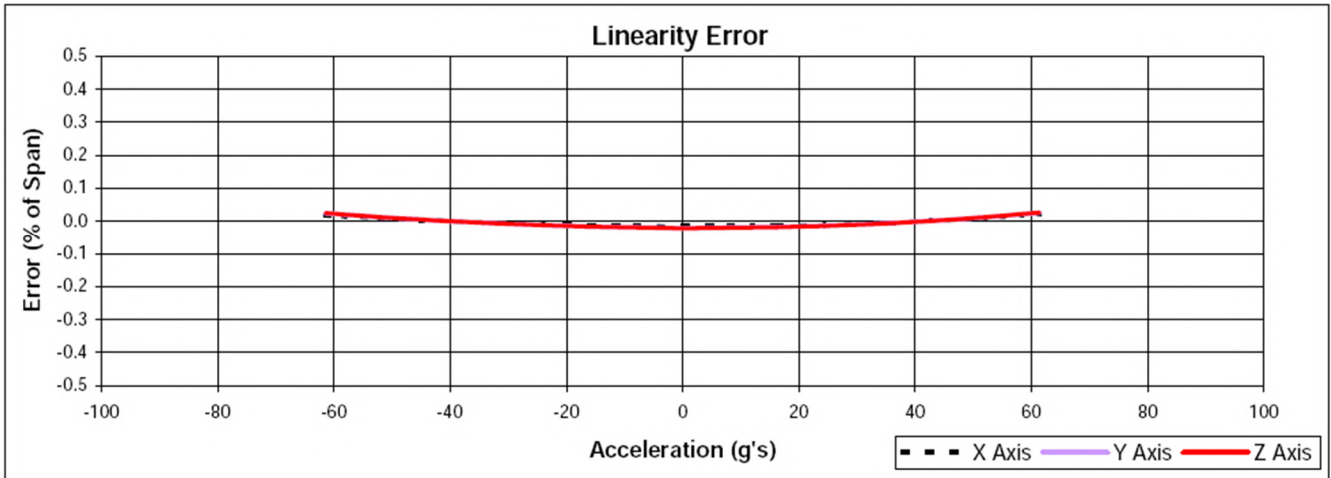

SPECIFICATIONS SUBJECT TO CHANGE WITHOUT NOTICE