



Nova II

Nova II

Laser Power/Energy Meter

User Manual

Table of Contents

Chapter 1. Introduction: How to Use This Manual	4
Chapter 2. Quick Reference	5
2.1 Getting Started.....	5
2.2 Functions with no Sensor Connected	6
2.3 Thermal Sensors.....	9
2.4 Photodiode Sensors.....	14
2.5 Pyroelectric Sensors	16
Chapter 3. The Nova II Meter	21
3.1 General Description	21
3.2 Smart Connectors	22
3.3 Soft Keys.....	22
3.4 Power Up and Shut Down.....	24
3.5 Nova II Functions, which are independent of Sensor Type	25
3.6 Hardware Functions	28
Chapter 4. Operation with Thermopile Absorber Sensors	32
4.1 Thermopile Absorber Sensors.....	32
4.2 Selecting Settings from the Nova II Screen	33
4.3 Startup and Configuration of Defaults	35
4.4 Power Measurement.....	36
4.5 Energy Measurement.....	45
4.6 Advanced Meter Screens	50

Chapter 5. Operation with Photodiode Type Sensors	54
5.1 Photodiode Sensors.....	54
5.2 Setting up the PD300 to display the user's chosen wavelengths	55
5.3 Startup Defaults.....	56
5.4 Selecting Settings from the Nova II Screen	57
Chapter 6. Operation with Pyroelectric Sensors .	64
6.1 Pyroelectric & Photodiode Energy Sensors	64
6.2 Selecting Settings from the Nova II Screen	65
6.3 Startup and Configuration of Defaults	69
6.4 Energy, Power or Exposure Measurement.....	71
6.5 Measuring Repeating Pulses of High Energy	77
6.6 Energy Log	77
6.7 Pyro Scope Adapter	79
6.8 PE-DIF Diffuser Sensors	79
Chapter 7. BeamTrack Features.....	81
7.1 Track Screen.....	81
7.2 Menu Screen.....	82
7.3 Stability Screen	82
7.4 Statistics Screen	83
7.5 Optimizing Measurements	83
Chapter 8. Circuit Description	85

Chapter 9. Calibration, Maintenance and Troubleshooting..... 87

9.1 Calibration of Thermopile or RP Sensors..... 87

9.2 Calibration of Photodiode type Sensors 91

9.3 Calibration of Pyroelectric type Sensors 93

9.4 Error Messages 97

9.5 Troubleshooting..... 98

9.6 Maintenance 99

Chapter 10. Nova II Specifications 100

10.1 System/Meter Specifications 100

10.2 Sensor Specifications 101

Chapter 1.

Introduction: How to Use This Manual

The Ophir Nova II is a microprocessor-based Laser Power/Energy Meter providing a broad range of measurements, displays, and data handling options. It operates with thermopile, pyroelectric and photodiode sensors, and uses smart connector technology. Just connecting the sensor configures and calibrates the instrument.

This manual tells you what you need to know to make full use of the Nova II for all your laser measurement needs. It includes a "Quick Reference", (Chapter 2) to allow you to perform basic measurements immediately, without reading the whole manual.

The main measurement sections, Chapters 4, 5 and 6 include a general description and a section detailing operating options.

Chapter 2. Quick Reference

2.1 Getting Started

The Nova II is equipped with "soft keys." That is the functions of the keys change as indicated by the legend above each key. (See Figure 2.2).

To connect sensor to the Nova II Meter

Insert the 15 pin D type connector of the measuring sensor cable into the socket marked "Head Input" on the rear panel of the Nova II meter. (See Figure 2.1)

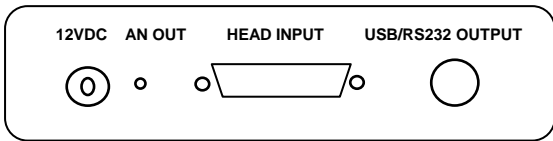

Figure 2.1
Nova II Rear Panel View

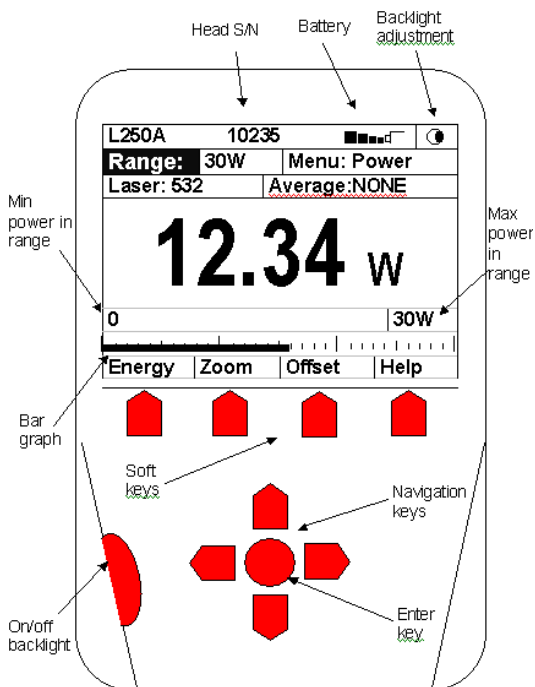

Figure 2.2

2.2 Functions with no Sensor Connected

2.2.1. Turning on and off.

To switch the Nova II on:

Briefly press the on/off/backlight switch. (Figure 2.2)
The unit will switch on, and the display will appear.

Note:

The sensor must be plugged in before the unit is switched on.

To switch the backlight on and off:

After the Nova II is switched on, press the on/off/backlight switch briefly again. The backlight will switch on. To switch off the backlight, press the switch again.

To switch the Nova II off:

Press the on/off/backlight switch and hold it for ~ 3 seconds until the display blanks.

If you wish to save the current Nova II configuration, use the "configure" function. (See section 2.2.2).

2.2.2. Display Options

To zero instrument:

1. Disconnect the sensor, turn off then on again. "Head Disconnected" will be displayed.
2. Make sure instrument is not in an electrically noisy environment and is undisturbed.
3. Press zero and then start.

To set the Display Modes:

1. Disconnect the sensor and switch off then on again. "Head Disconnected" will appear.
2. Select "display mode" and enter. Choose the desired mode and press save. **The Nova II will now be in this display mode for all sensors.**
3. Select "date" and press the enter button. Using the navigation keys set to the correct date. Press save.
4. Select "time" and enter. Using the navigation keys, set to the correct time. Press save.
5. For adjusting RS232 baud rate and An. Output voltage see sections 3.5.2 and 3.5.3.

Setting Contrast:

1. Disconnect the sensor, turn off then on again. "Head Disconnected" will be displayed.
2. With the navigation keys go into the contrast setting menu with the icon .
3. Press enter and with the up/down navigation keys increase or decrease. Press enter when finished.

Language options:

Nova II has two language options, English and Japanese. In order to switch from English to Japanese:

1. "Language" is found either in "Head Disconnected" screen (without a sensor connected) or in "Instrument" screen (with sensor connected).
2. With the navigation keys go to "Language".
3. Press enter and with the down key choose "Japanese".
4. Press enter when finished.

Warning:

In the event that you mistakably saved the Japanese language as the Nova II startup language, the way to switch back to English is:

- a. Disconnect the sensor from the Nova II.
- b. Turn the Nova II off and on again. You will reach the instrument setup screen (titled "Head disconnected" in Japanese).
- c. Press the down arrow 4 times.
- d. Press enter (central key). This will open a window to select the instrument language.
- e. Select "English" and press enter (central key).
- f. Press the "save" soft key and English will now be saved as your startup language.

2.2.3. Updating the firmware of the Nova II.

1. Download the latest firmware version of the Nova II from the Ophir website: www.ophiropt.com/photonics and copy to your target directory.
2. Turn on the Nova II.
3. Connect the USB communication cable to the Nova II and the PC.
4. Using the StarLab software press "select device".
5. Select Nova II. The device name will be highlighted in blue.
6. Select "upgrade Nova II".
7. Browse and select the file N2AXXX.BIN, where XXX is the latest firmware version of the Nova II.
8. Press "start".
9. The status will show "programming" for several minutes.
10. The status will show a green V sign and state "finished".
11. Press "Done".

2.3 Thermal Sensors

2.3.1. Use of Nova II with thermal type sensors.

Most Thermopile sensors have somewhat different absorption at different wavelengths. In order to compensate for this, each sensor has been calibrated by laser at several wavelengths. When you choose the correct laser wavelength, the correction factor for that wavelength is automatically introduced. Note that the laser wavelength correction in use is displayed in the upper left corner of the display.

Thermopile sensors with the LP1 absorber have large variation of absorption at different wavelengths. Therefore a continuous spectral curve is inserted into the sensor, enabling the user to choose the desired wavelength from the range specified in the specification sheet and the correction factor for that

wavelength is automatically introduced (This feature is available using the Nova II meter with software v 1.59 and above).

To set type of laser being used:

With sensors with fixed wavelengths:

1. While the Nova II is off, plug in the sensor then switch it on again.
2. Press the navigation keys until "laser" is highlighted. Press the enter key and select the appropriate laser wavelength.
3. If you want to save this new wavelength as the startup default, press "save" or return to main screen by pressing the enter key.

With continuous spectral curve:

1. While the Nova II is off, plug in the sensor then switch it on again.
2. From the main measurement screen, press "laser" to select the correct laser wavelength. If you want to save this new wavelength as the startup default, press "save" before exiting. If the wavelength you want is not among the wavelengths in the six wavelength list and you want to change or add a wavelength, see section 3.
3. Changing Chosen Wavelengths:
 - 3.1. From the power measurement screen select "laser" and enter. Move to the wavelength you wish to change or add. Press the right navigation key.
 - 3.2. Using the up/down navigation keys to change each number and the right left keys to move to the next number, key in the wavelength you want. Press enter to exit. If you wish to save this new wavelength as a startup default, press "save". Now press enter.

Note:

If you save in the Modify wavelength screen, the new wavelength will automatically be saved as the startup wavelength. Therefore, you must separately save the modified wavelength and then, in the next higher menu, the wavelength selected as startup from the 6 default wavelengths.

To choose manual or automatic ranging in power measurement:

1. Select "range" with the navigation keys. Press the enter key.
2. Select the appropriate manual range or AUTO.
3. If you want to save this new range as the startup default, press "save" or press the enter key to return to the main measurement screen.

To choose power or energy measurement:

1. To go from the main power measurement screen to the energy measurement screen, press the lower left soft key "energy".
2. To go from the energy measurement screen to power measurement, press "power".

2.3.2. Setting and Saving the Startup Configuration

1. Turn on the Nova II with the sensor connected, select "menu" and enter. Select "configure" and enter.
2. Now, with the navigation keys select "Startup mode", press the enter key and select "power" or "energy" as the startup mode. Press enter again to exit. If you want this mode to be permanent, Press save after pressing enter.
3. Now, with the navigation keys select "display mode". Press the enter key and select the type of screen you wish to start up with. Press save and exit. If you do not want to save this as the startup mode but only change for now, press enter and exit without save. (This choice is saved in the

instrument and not the sensor so the Nova II will start up from the screen selected for all sensors).

4. Now select "Power range", press enter and choose the manual power range you wish to be the default or choose auto range.
5. Now select "average" to select what period you wish to average power over or select the default, "none". See section 4.4.2.4 for details.
6. Now select "Energy Range" and choose the default energy range.
7. Now select "Energy threshold" if you wish to change the energy threshold. See section 4.5.3 for details.
8. Select "Laser" and select the laser type you wish to be the default.
9. Press "save" to save all present settings then "exit" to get back to the main measurement screen. Further details on configuration in section 4.3.

2.3.3. Power or Single Shot Energy Measurement

Warning:

Do not exceed maximum sensor limits for power, energy, power density and energy density as listed in Table 5. and Table 6. in Chapter 10. Otherwise, there is a risk of damaging the absorber.

To select an analog needle type display for the Nova II:

1. Select "menu" and enter. Select "needle" and enter. The display will now show a simulated analog needle type display.
2. In order to expand the display, press "expand".

To use the Nova II to measure Laser power:

1. Verify that the display shows "Menu: Power" in the upper right hand side of the display.
2. If the display shows "Menu: energy" and units of J, mJ etc. then press "power" to switch to the power measurement mode.

To expand the bargraph scale $\pm 5x$ about the present reading:

1. Press the "zoom" button .
2. Press the "zoom" button again to return to the ordinary bargraph. See Section 4.4.2.1 for full details.

To subtract background and set current reading to zero:

1. From the main power measurement screen press "offset".
2. Press "offset" again to cancel. See Section 4.4.2.2 for full details.

To use the Nova II to fine-tune Laser power:

1. From the main power measurement screen select "menu" and enter. Now select "tune" and enter.
2. Set the percentage range of the power scale to be displayed by repeatedly pressing the $\pm 50\%$ key.
3. Now select the horizontal sweep time you desire by selecting "graph" and choosing the time scale.
4. You may now use the screen to tune the laser power. See Section 4.4.2.3. for full details.
5. Press "power" to exit to the main measurement screen.

To use the Nova II to measure Laser energy:

1. Verify that the display shows "energy" in the upper right hand side of the display.
2. If the display shows "power" and units of W, mW etc. then press "energy" to switch to the energy measurement mode.
3. The energy mode is manual ranging. Select "range", enter then use the navigation keys to select the proper range. Press save if you want this range to be the startup default. The correct range is the lowest one that is larger than the pulse energy measured. Note that the range will be displayed in the lower right corner of the main display.

4. When the Nova II screen flashes "ready," on and off, fire the laser. See Section 4.5 for full details.

To save configuration:

1. To save configuration, follow directions in Section 2.2.2 above.

2.4 Photodiode Sensors

2.4.1. Selecting Wavelengths

1. While the Nova II is off, plug in the sensor then switch it on again.
2. From the main measurement screen, press "laser" to select the correct laser wavelength. If you want to save this new wavelength as the startup default, press "save" before exiting. If the wavelength you want is not among the wavelengths in the six wavelength list and want to change or add a wavelength, see section 2.4.2 below.
3. Follow the directions on configuration in section 2.4.4 below.

2.4.2. Changing Chosen Wavelengths

1. From the power measurement screen select "laser" and enter. Move to the wavelength you wish to change or add. Press the right navigation key.
2. Using the up/down navigation keys to change each number and the right left keys to move to the next number, key in the wavelength you want. Press enter to exit. If you wish to save this new wavelength as a startup default, press "save". Now press enter.

Note:

If you save in the Modify wavelength screen, you will save this wavelength as one of the startup wavelengths. If you press save in the next higher menu, you will save the selected wavelength as the chosen one for startup. Therefore, you must separately save the modified wavelength and the

wavelength selected as startup from the 6 default wavelengths.

2.4.3. To choose manual or automatic ranging or dBm in power measurement

Select "range" and enter. Using the navigation keys, select the appropriate manual range autorange or dBm (logarithmic scale).

2.4.4. Setting the Startup Configuration

1. Select menu and press enter. Select "configure" and enter.
2. Select "filter" and enter. Choose filter in or out to be the default. If you want to save this as default startup, press save. If you only want to change for now, exit without saving.
3. Now select "display mode" and choose which screen you want the instrument to start up in. Press enter. (Note that this is an instrument setting and will be valid for all sensors.)
4. Now select "Power Range:" and choose the manual power range you wish to be the default or choose autorange or dBm.
5. Now select "Average:" and choose which period to average power over or leave the default "NONE".
6. Now select "laser" to choose the startup laser wavelength. See Section 2.4.2 above for details.
7. When finished exit. For further details on configuration see Section 5.3.

2.4.5. Power Measurement

Warning:

Do not exceed maximum sensor limits for power, energy, power density and energy density as listed in Table 5. and Table 6. in Chapter 10. Otherwise, there is a risk of damaging the absorber.

To expand the bargraph scale $\pm 5x$ about the present reading:

1. Press the "zoom" button.
2. Press the "zoom" button again to return to the ordinary bargraph.

To subtract background and set current reading to zero:

1. From the main power measurement screen press "offset".
2. Press "offset" again to cancel. See Section 5.4.5 for full details.

To use the Nova II to fine-tune Laser power:

1. From the main power measurement screen select "menu" and enter. Now select "tune" and enter.
2. Set the percentage range of the power scale to be displayed by repeatedly pressing the $\pm 50\%$ key.
3. Now select the horizontal sweep time you desire by selecting "graph" and choosing the time scale.
4. You may now use the screen to tune the laser power. Press "power" to exit to the main measurement screen. See Section 4.4.2.3 for full details.

2.5 Pyroelectric Sensors

2.5.1. Zeroing Instrument against Sensor

For most accurate calibration, you must zero the pyroelectric sensor against the Nova II it is being used with. Proceed as follows: Make sure the sensor is in a quiet environment and not subject to pulsed radiation. Plug sensor into Nova II and turn on. Press "menu", select "zero" and enter. Press "start". When "zeroing completed" appears, press "save". Press "exit" and then choose the screen from the menu that you wish to use. After you have done zeroing, you do not have to do it again when used with the same type of meter. If you have zeroed it against a different type of meter, then a

different value has been saved and when used with a Nova II again you should zero it again.

2.5.2. Changing Chosen Wavelengths (metallic type only)

1. Select "laser" and enter.
2. Select the wavelength you wish to use and enter. If you wish to save this wavelength as the startup default, press save before exiting.
3. If you wish to modify one of the wavelengths, select the wavelength and press the right navigation key.
4. Now, using the up/down navigation keys to change the numbers and the right/left keys to move to the next number, modify to the wavelength you want.
5. When finished, press "save" and exit. If you only want a temporary change, exit without "save".

2.5.3. To set type of laser being used

From main measurement screen, select "laser" and enter. Choose the desired laser type or wavelength. If you want this one to be the startup wavelength, press save before exiting.

2.5.4. Setting Startup Configuration

1. Turn on the Nova II with the sensor connected, select "menu" and enter. Select "configure".
2. Now, with the navigation keys select "Startup mode", press the enter key and select "power" or "energy" as the startup mode. Press enter again to exit. If you want this mode to be permanent, press save after pressing enter.
3. Now, with the navigation keys select "display mode". Press the enter key and select the type of screen you wish to start up with. Press save and exit. If you do not want to save this as the startup mode but only change for now, exit without save. (This choice is saved in the instrument and not the sensor so the Nova II will start up from the screen selected for all sensors).

4. Now select "energy range", press enter and choose the manual energy range you wish to be the default.
5. Now select "average" to select what period you wish to average power over or select the default, "none".
6. If the sensor is a diffuser sensor, now select diffuser in or out.
7. Now select "max pulse len" and choose the shortest pulse length setting longer than your laser's pulse length.

Warning:

Incorrect readings will result if pulse length is not set up correctly.

8. Select "Laser" and select the laser type you wish to be the default.
9. Press "save" to save all present settings then "exit" to get back to the main measurement screen.

Note:

Some sensors have only one pulse length setting for all pulse lengths. In that case N/A appears. For further details on configuration see Sections 6.2 and 6.3.

2.5.5. Energy or Average Power Measurement

Warning:

Do not exceed maximum sensor limits for power, energy, power density and energy density as listed in Table 5. and Table 6. in Chapter 10. Otherwise, there is a risk of damaging the absorber.

With the pyroelectric sensor, you have been supplied a test slide with the same coating as on your pyroelectric detector. You can also obtain this slide from your dealer. You should use this slide to test the damage threshold with your laser pulses. If the slide is damaged, then either enlarge your beam or lower the laser energy until damage is no longer seen.

Note:

High sensitivity piezoelectric sensors (PE-9, PE-10) are very sensitive to vibration, and therefore might read a false trigger when operating in an acoustically non-stable environment. Set the threshold to a high enough value that false triggering does not occur. Ophir also offers a shock absorbing mounting post (P/N 7Z08268) that helps reduce vibration on the sensor.

2.5.5.1. To choose Energy or Average Power Measurement

1. To go from the main energy measurement screen to power measurement, press "power".
2. To go from the main power measurement screen to energy measurement, press "energy".

2.5.5.2. To use the Nova II to measure Laser Energy and Frequency

1. In measurement mode, verify that the units are mJ, μ J etc. and "energy" is displayed in the upper right corner. If not, press the "energy" key.
2. Select "range", enter then use the navigation keys to select the proper energy range. The correct range is the lowest one that is larger than the pulse energy measured. Press "Save" if you want that range to be the startup default. Press "Exit".
3. If the sensor triggers from ambient vibration or noise without a laser signal raise the threshold level as follows: Select "Threshold", enter then using the up/down buttons, raise the threshold until the false triggering stops. If the sensor does not read the pulses at all on the lowest range, try to lower the threshold to minimum.

Warning:

While measuring pulsing lasers, erroneous energy reading will result if energy range is not set up correctly. See Section 6.4 for details.

2.5.5.3. To measure Total Energy Exposure.

1. From the energy measurement screen select "menu", enter and select "exposure". Enter.
2. Select the method of measurement with "mode", "timeout" and "pulses" then press "start". Press "start" again. The Nova II will start summing laser energy exposure. If you wish to stop before the chosen period, press "stop".
3. If you wish to reset the reading to zero before another reading, press "reset".
4. To return to the main screen and press "energy".

Chapter 3.

The Nova II Meter

3.1 General Description

The model Nova II laser power/energy meter represents a new level of sophistication, sensitivity, compactness and accuracy, coupled with ease of operation. It can operate with thermal, pyroelectric and photodiode sensors. It has smart connector technology. Simply plugging in the sensor configures and calibrates the Nova II to operate with that sensor.

The Nova II can graph power or energy vs. time. It displays power measurements in both digital and analog form at the same time and also has a needle type display. It will also autorange, so you do not have to set scales; or it can manual range if you wish. It will remember what mode you were using before you turned it off and will return to that mode when turned on. You can zoom in on the present reading, or subtract background. Although the calibration information is stored in the smart connector, you can recalibrate from the screen and store the new calibration in the sensor. You can also zero the Nova II at the touch of a button.

The main instructions as well as full help files are clearly shown on the screen so you should not have to refer to this manual very often. Above all, the Nova II has advanced circuitry and digital signal processing for excellent sensitivity, signal to noise ratio, accuracy, and response time. It also has special circuitry to reject electromagnetic interference.

The Nova II comes with built in connection to PC via either USB or RS232 and comes with PC software to display and process the information.

3.2 Smart Connectors

The Nova II meter is versatile and can operate with either thermal, pyroelectric or photodiode type laser measuring sensors. The sensor configuration and calibration information is stored in an EEROM in the sensor connector plug. This means that when the sensor is plugged in, the Nova II automatically identifies the sensor type, calibration and configuration. The user does not have to adjust anything.

Note:

In ROM versions earlier than 1.96, the Nova II does not recognize when a sensor has been disconnected. Therefore, when changing sensors, the meter should be turned off; the new sensor plugged in; and then the Nova II should be turned on again. From ROM version 1.96, this is no longer necessary, as the Nova II will recognize when a sensor has been disconnected and will restart itself. See section 3.6.6 for details

When no sensor is plugged in and the Nova II is turned on, the meter indicates "Head Disconnected" and gives the user the opportunity to change the baud rate, re-zero the instrument, set the real time clock or other features. See section 3.5.

3.3 Soft Keys

3.3.1. Soft Keys

The soft keys accessed by the menu button have functions defined by the legend above the key. The legend usually indicates what will happen when pressing the key. For example, if "energy" appears above a key, pressing that key will change the Nova II into energy mode. Some functions operate when the key is pressed and are canceled when the key is pressed again. Those keys show reverse highlighting when operational. Pressing the same key again cancels the operation and the highlighting.

Key Functions

The Nova II has certain conventions as to the meaning of standard key strokes and these are as follows:

Highlighted item: The highlighted item is the item presently active.



These buttons move to the next active item leftwards, rightwards. These are the navigation buttons. The right and left buttons move to the next active item rightwards and leftwards. The up and down buttons move to the next active item upwards and downwards. The round button in the center is an enter button to enter the screen of the item selected or when finished, to leave that screen.

Go or Start:

This puts into operation the active item.

Exit:

This gets you to the previous screen and saves changes made until instrument is turned off.

Save:

This saves changes permanently. The change is implemented now and is also saved for future use of the instrument.

3.4 Power Up and Shut Down

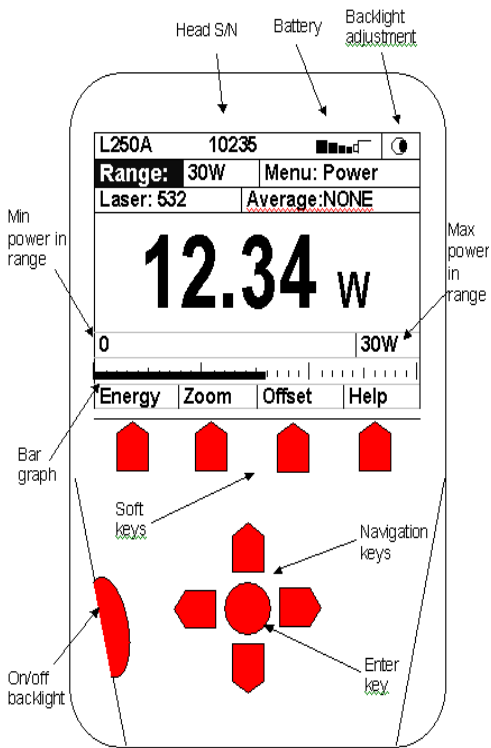

Figure 3.1

To turn the Nova II on:

Briefly press the on/off/backlight switch. (See Figure 3.1)

The unit will switch on, and the display will appear. If no sensor is connected, a display showing "Head Disconnected" will appear. If a sensor is connected, the appropriate default measurement screen will appear.

To turn the backlight on and off:

After the Nova II is switched on, press the on/off/backlight switch briefly again. The backlight will switch on. To switch off the backlight, press the switch again.

To switch the Nova II off:

Press the on/off/backlight switch and hold it for ~ 3 seconds until the display blanks.

If you wish to save the current Nova II configuration, use the "configure" function before switching off. For measurements of the same type, the Nova II does not need to be set up each time. See the appropriate section in the chapter dealing with the sensor type you intend to use.

3.5 Nova II Functions, which are independent of Sensor Type

When no sensor is connected to the Nova II and it is turned on, the message "Head Disconnected" appears. In this mode, the user can adjust the startup screen, either the standard power/energy screens or other specialized screens. He can adjust the baud rate for optimum communication with PC, choose the appropriate analog output Max. value, or the user can zero the instrument to eliminate any offsets. He can adjust the real time date and time setting.

3.5.1. Display Mode

The Nova II can operate in the standard power/energy measurement screen or needle type display or can display the information in specialized forms: an attenuation screen, a tune/exposure screen, a power/energy density screen, a screen normalized to some value or a screen with limits. Select "display mode", enter and set the screen to the type you want the instrument to start up in and then exit by pressing the enter button again. (For more details on the various screen options, see section 4.6) .

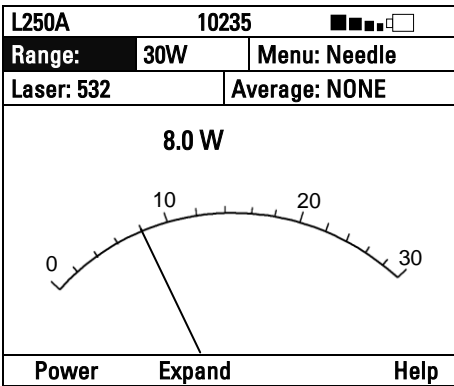

Figure 3.1.1
Needle Screen

3.5.2. RS232 Baud Rate

If you are using the Nova II for RS232 communication with PC, the baud rate can be set by selecting "RS232 baud" and selecting the appropriate rate then pressing enter and save. Unless you need especially fast communications, leave the default of 9600.

3.5.3. Analog Output

The Nova II has a feature of adjustable analog output 10 Volts full-scale output. To set the analog output voltage, select "An. Output" enter, select the voltage, enter again and save.

For thermal and photodiode sensors in power mode, the analog output is continually updated 15 times per second with the latest power measurement. For thermal sensors in single shot energy mode, the analog output can be configured to be held fixed until the next pulse triggers or to be released when ready to measure the next pulse. For pyroelectric sensors, the analog output is updated at up to 10 times per second with the latest pulse energy.

3.5.4. Clock Settings

The Nova II is equipped with a real time clock which will show the date and time. This clock will also allow the Nova II to query the sensor attached and notify you if the sensor is due for calibration.

To set the clock, select "Date" and enter. First select the month with the up/down navigation keys, then move to the date with the right/left keys and so on. Save and enter. Do the same with the time.

3.5.5. Zero Adjustments

In the Nova II, all adjustments, including zeroing internal circuits, are done from the software. This ensures simple and accurate realignment. It is recommended to re-zero the Nova II every 2 months for best performance. The simple zeroing procedure follows.

1. If a sensor is connected, disconnect the sensor, turn off the instrument then back on again so the Nova II can identify that no sensor is connected. "Head Disconnected" will be displayed.
2. Let the Nova II run for at least 30 seconds before performing zero adjustment.

3. Press "zero".
4. Make sure the instrument is not in an electrically noisy environment and is undisturbed. Press "start" and wait for message, "zeroing completed". Now press "save" and the new zero will be saved. Press "exit" to return to the main screen.

Note (for Thermal Sensors only):

For best results with thermal sensors, it may be necessary to do the procedure once with the sensor disconnected then afterwards again with the sensor connected.

After completing steps 1 - 4 above, Connect the sensor and make sure it is at room temperature and well shielded from any stray thermal power. It may be best advised to lay the sensor with the absorber face down on the table.

5. Switch the instrument off then on again with the sensor connected.
6. Select "menu" and choose "zero". Press "start" and wait for message, "zeroing completed". Now press "save" and the new zero will be saved. Press "exit" to return to the menu. Press "exit" and then choose the screen from the menu that you wish to use.

Note: For Pyroelectric Sensors

In addition to zeroing the meter as described in section 3.5.5, it is important to zero the meter against the sensor you are using the first time. Please see section 2.5.1 on how to do this.

3.6 Hardware Functions

3.6.1. Backlight

The backlight illuminates the meter from the rear and is operated by the same switch as turns the instrument on and off (See Figure 3.1). The Nova II backlight consumes considerably less power than competing instruments and therefore it can operate from the

battery even when the charger is not plugged in. Nevertheless, since it does shorten the time between charges, it is recommended to operate the instrument without the backlight when the instrument is operated without the charger. The electro luminescent backlight has a finite lifetime of about 10,000 hours. Therefore, it is recommended to use it only when necessary.

To operate the backlight, press the on/off/backlight switch briefly while the Nova II is on. To turn off the backlight, press again briefly. (If the switch is pressed for ~3s, the instrument will turn off).

3.6.2. Charging

The Nova-II can be operated either by battery or from an AC source with the charger plugged in all the time. Plug the charger in the jack labeled "12VDC" on the back panel, (Figure 2.1). The Nova-II's 12v input has dual polarity. The batteries will be charged at the same rate whether the Nova-II is switched on or off, and whether the backlight is on or off. The Nova-II will fully recharge in around 5 hours.

The approximate time between charges is given below for various configurations:

Thermal, Photodiode sensors, no backlight:	18hrs.
Same, with backlight:	9hrs.
Pyro sensors, no backlight:	13hrs.
Same, with backlight:	8hrs.

The battery charge is indicated by the  icon. The battery charge is shown approximately by each segment of the icon, e.g. if 2 segments are shown the battery is 1/2 full. When the battery is charging, the segments turn on in sequence. When the battery is low, the charger should be plugged in. While the unit will charge even while on and even with the backlight on, it will charge fastest if the charger is left in while the unit is off.

3.6.3. Analog Output

The instrument provides an analog voltage output via the 2.5mm mono jack socket on the rear panel marked "AN OUT". (See Figure 3.2). The Nova II is supplied with the mating adapter plug that connects to this socket. The analog output is useful for driving chart recorders and other analog devices. The voltage is proportional to the reading on the display and scaled such that full scale equals 1.00, 2.00, 5.00 or 10.00 volts as selected by the user during setup. (See section 3.5.3). The analog output is driven through an impedance of 100ohm. For best accuracy, is recommended to limit the external load to 100K (or larger). A smaller load (down to 1K) is possible, but may result in loss of accuracy.

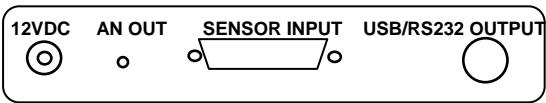



Figure 3.2
Nova II Rear Panel View

3.6.4. LCD Contrast Adjustment

The LCD contrast can be adjusted as follows:

1. Disconnect the sensor, turn off then on again. "Head Disconnected" will be displayed.
2. With the navigation keys go into the contrast setting menu with the icon .
3. Press enter and with the up/down navigation keys increase or decrease. Press enter when finished.

3.6.5. RS232 and USB Outputs

The Nova II is equipped for either RS232 or USB communications with PC. The Unit is supplied with two cables, each with a 7 pin DIN plug on one end mating with the Nova II and either a USB or 9 pin D RS232 connector on the other side. When you wish to operate the Nova II with either RS232 or USB, the cable should be inserted before switching on the instrument and

then the instrument will automatically either be in RS232 or USB mode depending on which cable is attached. See section 4.4.2.6.1 for details of communication with PC.

3.6.6. Sensor Disconnect / Connect Recognition

As of ROM version 1.96, the Nova II meter will recognize if a sensor had been connected or disconnected while the device is powered on. If such an event happens, a warning screen will be displayed for 3 seconds, after which the Nova II will restart itself in its new configuration. Thus if a user wants to change sensors during his experiment he no longer needs to power down the Nova II to do so.

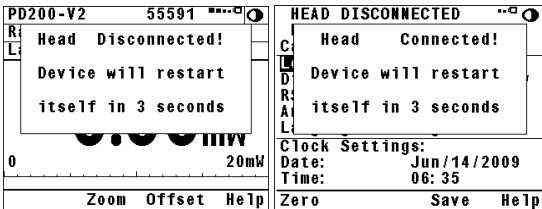

Figure 3.3
Sensor Disconnect / Connect Warnings

Note:

When working with Ophir's StarLab application, the Nova II's restarting itself will be recognized as a Device Disconnect.

Chapter 4.

Operation with Thermopile Absorber Sensors

Warning:

Before using the sensor for power or energy measurement, check that your laser power, energy and energy density do not exceed the sensor ratings. See Table 5. and Table 6. in Chapter 10.

If the sensor is a water-cooled type, ensure that the cooling water is flowing at an adequate rate; see table below. Also, note that the reflectance from the absorber could be as much as 10% and with CO₂ lasers, the reflected beam can be quite specular, so it is advisable to provide a beam stop for the reflected beam with the highest power lasers.

Sensor Type	Liters per Minute At Full Power	Min Pressure Bar	US Gallons per Minute
10K-W	9	2	2.5
5000W	4.5	0.8	1.2
1500W	2.5	0.5	0.7
1000W	1.8	0.5	0.5

Table 1.
Minimum Flow Rates For Water-Cooled Sensors

4.1 Thermopile Absorber Sensors

When a radiant heat source, such as a laser, is directed at the absorber sensor aperture, a temperature gradient is created across the thermopile of the enclosed detector disc. This generates a voltage proportional to the incident power.

The meter amplifies this signal and indicates the power level received by the sensor. At the same time, signal processing software causes the meter to respond faster than the thermal rise time of the detector disc, thus reducing the response time of the Nova II. Energy of a single pulse is measured on the Nova II by digitally integrating the pulse power over time.

4.2 Selecting Settings from the Nova II Screen

The Nova II can be set to various chosen settings while operating. In addition, it can be set so that it will be in the desired configuration when turned on the next time.

4.2.1. To Set Type of Laser being Used

Thermopile sensors have somewhat different absorption at different wavelengths. In order to compensate for this, each sensor has been calibrated by laser at several wavelengths. When you choose the correct laser wavelength, the correction factor for that wavelength is automatically introduced. Note that the laser wavelength correction in use is displayed in the upper left corner of the meter.

Thermopile sensors with the LP1 absorber have large variation of absorption at different wavelengths. Therefore a continuous spectral curve is inserted into the sensor, enabling the user to choose the desired wavelength from the range specified in the specification sheet and the correction factor for that wavelength is automatically introduced (This feature is available using the Nova II meter with software v 1.59 and above).

4.2.2. To choose Manual or Automatic Ranging in Power Measurement

Autorange - The Nova II allows you to choose autorange or manual ranging. In autorange mode, you do not have to change scales. When the reading of the meter or bar is more than 100% of full scale, the range goes to the next higher one. The ranges are arranged

in factors of 1, 10, 100, etc. When the reading falls below 9% of full scale, the range changes to one range lower. This change only occurs after a few seconds delay. This provides overlap (hysteresis) to keep the Nova II from flipping back and forth when reading close to the end of the scale.

To choose auto range, select "Range", enter, choose "AUTO" then enter again. If you wish the Nova II to be in manual mode when switched on, save this configuration before switching off See Section 4.3.

Manual Range - There are certain disadvantages to autorange since it changes scale even if you don't want it to do so. If you want to measure the same range all the time, it is better to use manual range. To select manual range, select "range", enter, select the desired range, and then enter again to return to the measurement screen.

The correct range to select is the lowest one that is larger than the largest expected measurement. If you wish the Nova II to be in manual mode when switched on, save this configuration before switching off -See Section 4.3.

4.2.3. To choose Power or Energy Measurement

The Nova II thermopile sensors can measure both power and single shot energy. See Sections 4.4 and 4.5 for details. To change from power to energy measurement or vice versa do the following:

1. To go from the main power measurement screen to energy measurement, press "energy".
2. To go from the energy measurement screen to power measurement press the "power" soft key.

4.3 Startup and Configuration of Defaults

If you are planning to do measurements of the same type most of the time, you can set up the Nova II so that it automatically starts up in the measurement mode desired. Since these settings are saved in the sensor "smart connector", you can save different settings for different sensors.

To set the Nova II to start up in desired screen and to save the chosen configuration:

With the sensor connected, switch on the Nova II. Select "Menu" with the navigation keys. Enter, select "configure" and enter again. Now choose the desired startup parameters as follows:

1. Select "startup mode" to choose "power" or "energy" for the desired startup screen. Choose power or energy and press enter and save. The Nova II will now start up in power or energy measurement mode, respectively, when switched on.
2. Now select "display mode" and select the desired startup screen. Press save (Note that this selection is saved in the Nova II and not the sensor so will be operative for all sensors). For more details on the screen types see section 4.6.
3. Now select "Power Range:" and in the same way choose the manual power range you wish to be the default or autorange. The Nova II will now be in the range selected when switched on with the sensor in question.
4. Now select "Average" and select the period you wish to average power readings over. This feature is especially useful for lasers with nonsteady output. See section 4.4.2.4 for details.
5. Now select "Energy Range" and choose the energy range you wish to be the default or autorange. The Nova II will now be in the range selected when switched on with the sensor in question. Note that there are only manual ranges in energy.

6. Now select "Threshold" if you want to change the energy threshold. See section 4.5.3 for details.
7. Now select "Laser" and select the laser type you want to be the default. The Nova II will now be correctly calibrated for the absorption of the detector at the wavelength of the laser type selected and will startup with the laser wavelength selected.
8. Now press "save" and "exit" and the defaults will be saved. If you only want the changes saved for the present, exit without save and the changes will be saved until the Nova II is switched off only.
9. Switch the Nova II off then on by means of the on/off/backlight switch. (See Figure 3.1). The Nova II will enter the mode of operation last saved with the "configure" operation.

4.4 Power Measurement

The next section describes the procedure for basic power measurement as well as more advanced features with thermal measuring sensors.

4.4.1. Power Measurement, Basic Operation

1. Switch the Nova II on by means of the on/off/backlight switch on the left side. (See Figure 3.1). The Nova II will enter the mode of operation last saved with the "configure" operation. For basic operation, you need only set up the parameters for the type of measurement you wish (Section 4.3 describes the procedure to store your configuration), and the Nova II will be ready to perform that type of measurement each time it is switched on. The normal default measurement mode is the bargraph autoranging power measurement screen or the needle display screen.
2. If the Nova II is in "energy" mode, pressing the "power" soft key will cause it to enter the power measurement mode.
3. Center the laser beam carefully on the absorber surface and read the power.

4.4.2. Additional Power Measurement Features

The following section describes additional Nova II functions in power mode in addition to the basic power measurement mode described above.

4.4.2.1. Zoom

The Zoom function causes the scale to expand the present scale fivefold. Thus, if the full scale of the bargraph is 20 watts, and your reading is 15 watts, pressing "zoom" will make the bargraph scale range between approximately 13 and 17 watts. Variations in power are more easily seen in this mode. To access the zoom function, simply press the "zoom" button. It will be highlighted to show that it is engaged. Note that the fiducial marks of the bargraph are further apart, indicating that zoom is engaged. Now press the "zoom" button again to return to the unexpanded bargraph display.

4.4.2.2. Offset

The offset function subtracts background from the signal. If the ambient environment has a thermal background, so that the Nova II shows a nonzero power reading even when there is no laser, you can subtract the background using the zero function. For example, the Nova II meter reads 0.1 Watts when the laser is blocked, and 20.5 Watts with laser power applied. In this case, the true power is $20.5 - 0.1 = 20.4$ Watts. To subtract the background, press the "offset" button while the laser is blocked. The Nova II will now read zero, and the 0.1 Watt background will be subtracted from all subsequent readings. The laser power reading will thus be 20.4 Watts.

When "offset" is engaged, the legend is highlighted. To cancel, press "offset" again. If the "offset" is engaged, and you wish to subtract out a new value of the background, press "offset" twice. The first press will cancel the old value, and the second will activate a new value. If you suspect that the Nova II has a

permanent zero offset, then disconnect the sensor while it is in the power measurement mode. If the Nova II still

shows a similar offset even when the sensor is not connected, the instrument's internal zero should be reset. See Section 3.5.5.

4.4.2.3. Tune See Figure 4.1

The Tune function, an exclusive Ophir feature, makes adjusting your laser to its maximum power easier than ever before. Unlike a bargraph or needle display, this display shows graphically what came before as well as the current reading and the trend. This allows you to determine if you have reached maximum power.

The screen is completely autoranging. Therefore, as soon as the cursor goes over the top or under the bottom edge of the display, it re-scales to put the cursor back to the middle of the screen. This allows you to devote all your attention to tuning the laser, without having to worry about the Nova II settings.

4.4.2.3.1. To use the Nova II to fine tune laser power

1. From the main measurement screen, select "menu" and enter. Select "tune" and enter.
2. Set the power expansion scale to $\pm 50\%$, $\pm 25\%$, $\pm 10\%$, $\pm 100\%$ or $\pm 75\%$ as desired, pressing the " $\pm 50\%$ " soft key. The default value is 50%. If the laser power will change a lot, use a large value; if a little, use a small value.
3. Select "graph" and enter to set the horizontal sweep time to the rate desired. The default value is 1 minute. Save before exiting if you want this to be the new default. Note that saving the graph value will also save the $\pm XX$ value as default.
4. If you press "max" it will set the NOW value on the screen to the present value. You can then compare the MAX value to the NOW value.

4.4.2.3.2. Measuring with the Tune Screen

You can now use the tune screen to adjust and maximize your laser power. (See Figure 4.1). Note that you can not only see the trend, but also see if you have already reached a higher value before the numbers on the left side show you the present power reading as well as the highest one reached till now. Press “max” to reset the maximum reading to the present time. Now measure the power of the laser and adjust the laser until you determine that the power has reached a maximum.

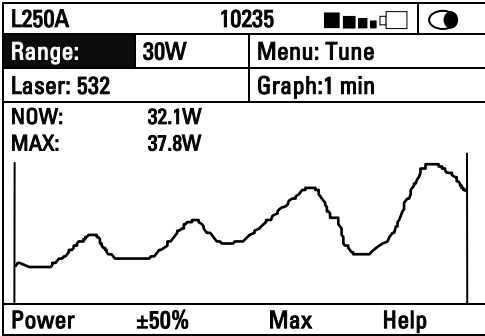

Figure 4.1
Power Tune Screen

4.4.2.4. Average

When a laser output is fluctuating or unstable, it is useful to measure the average power over a certain period. The Nova II gives you this exclusive feature, allowing averaging over periods varying from 1 s to 1 hour.

The average mode works as follows:

As soon as the main power measurement screen (See Figure 4.2) is entered and the instrument is set to average mode, the instrument displays the average of readings over the period since the screen was entered up to the present. When the time period of the average

is reached, the bargraph is filled and from then on, the average is a running average over the average period backward in time. For instance, if the average period is 1 minute, at 30 seconds, the average is over 30 s, at 1 minute it is over 1 min, at 5 minutes, it is over the period from 4 to 5 minutes (1 minute back from the present etc.).

To use the Nova II to display average:

1. From the main power screen, select "average" and enter.
2. Select the average period you want or select "NONE" if you do not want to average. Save this as the startup default if you want by pressing "save" otherwise just exit the screen.
3. **Note:**
Average setting only affects the Numeric display. Graphic readouts are not affected.

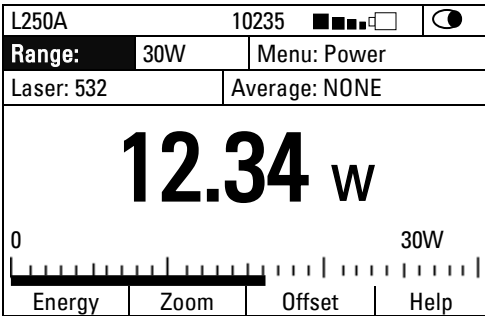

Figure 4.2.
Thermopile Power Screen

4.4.2.5. Normalize

When you wish to show the readings as compared to some standard reading, the normalize function allows you to do this. After setting "normalize", all subsequent readings will appear as a ratio to the reference reading. For instance, if you normalize the reading at a power of 1.5W, then subsequent readings will be with ratio to that, i.e. if the power is then 2W, the reading

(dimensionless) on the screen will be $2/1.5 = 1.33$. The screen will also show in small digits the power at which the normalization was done and the present power.

To use the Nova II to normalize the power:

1. From the main power screen, select "menu" and enter. Select "normalize" and enter.
2. When ready to normalize, press "apply". From then on, the power will be proportional to the normalized power value (See Figure 4.3).
3. If you wish to apply a new value, press "reset" and then "apply" again.
4. If you wish to return to the the regular display, select "menu", enter and go to the display you wish.

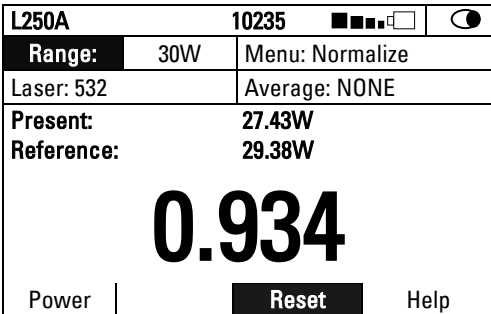

Figure 4.3
Thermopile Normalize Screen

4.4.2.6. Power vs. Time Graph and Data Logging

The Nova II in datalog mode has the option of graphing the laser power against time and storing the data in up to 10 permanent storage files with up to 5,400 data points in each file. While measurements are being taken, the Nova II will record data until the screen is full or until the reset button is pressed. With the RS232 or USB adapter the data can be read out to PC in real time or later after storage. Power logging has the following characteristics:

To use the Nova II to graph power vs. time:

1. From the main power measurement screen, select "menu" and enter. Select "data-log" and enter.
2. You are now in the setup screen. Under "Graph Settings", select "Min:" and enter. Select the value you wish for the minimum of the graph and enter. Now select "Max:" and enter. Select the maximum value you want for the graph and enter. Now select "Time scale:" and enter. Select the time scale you want and enter. If you wish to save these values as defaults, press "save" after entering them.
3. Now press "log".and you will be in the power graph screen (See Figure 4.4.). Press "go" and the measurement will begin immediately. The "go" button will now change to "pause". If you wish to pause the measurements without losing data gathered, press "pause" . Press "pause" again to resume measurements. When the data register is full, "FULL" will flash on the screen. If "zoom" is pressed at any time, the screen display will expand fivefold around the present power value. Press "zoom" again to cancel the expansion. If you want to start a new measurement and not save the present data, press "reset". If you want to save the data before making a new graph, see the next section.

Note:

For data logging, the instrument has to be in a manual power range. If it is not, a message will occur.

Warning:

Pressing "reset" will erase all previously stored data and start recording new data.

4. If you press the "stats" button, the graphical display will be replaced by a statistical summary of the data gathered till now. This summary is updated every 2 seconds.

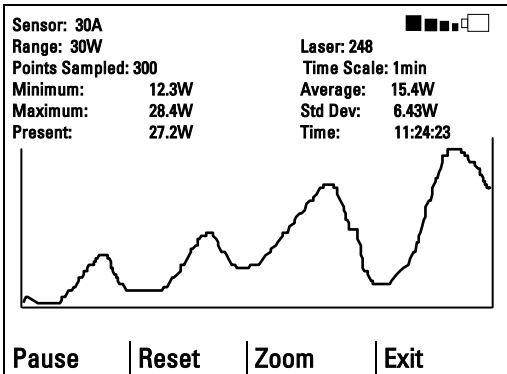

Figure 4.4.
Laser Power VS Time Graph

4.4.2.6.1. Data Storage and Transmission

When using thermal and photodiode sensors the data logging period is anywhere from 20 seconds to 600 hours. The number of points stored in the data register is up to 5,400 points, where less will be stored for data logging periods of less than 5 minutes.

The data can be stored to file as described below. To store the data do the following:

1. When you have gathered enough points press "pause" or wait until the data register is full and "FULL" flashes. Press "exit" and you will be asked if you want to enter the file control system. Press "yes".

Temp: 300					
1:	200	4:	0	7:	0
2:	0	5:	1340	8:	0
3:	0	6:	0	9:	0
				10:	0
Free Space: 58460					
Sensor: 30A			S/N: 104360		
Points Logged: 1340			Average: 23.4W		
Minimum: 19.4W			Std Dev: 2.43W		
Maximum: 27.3W					
Exit	Save	Delete	Help		

Figure 4.5
Data Storage Screen

- When the screen is entered, the data in the latest power graph will be stored temporarily in register "Temp". With the navigation buttons select the permanent register you wish to use for storing the data and press "save". The data in the "Temp" register will be transferred to the selected register. This data storage is permanent and the data is not lost when the instrument is turned off. If you try to save into a file which already has data, a warning will appear that the new save will erase previous data in the file. If you want to delete the data from a file, select the file and press "delete".
- At the bottom of the screen is a summary of the data in the selected file. If you press "exit" and then select "view files" and enter, you will be able to show the actual data points instead of a graph. Select the data file you want and press the Enter Key (middle button of the Navigation Keys). This will open a screen showing all the data points collected in this file. Press "XXX>" to get to the next page of data and "<XXX" to get to a previous page. Pressing "exit" will get you back to the previous screen.

Note:

In version 1.96, the internal file system format has been changed. To prevent possible corruption, logs made in versions earlier than 1.96 should be uploaded to the PC before upgrading the firmware version to 1.96 or higher.

Data Transmission to PC

The data stored in the Nova II file system can be transmitted to PC using the Starcom PC package supplied with the Nova II. The data can be transmitted in real time as well according to the following table:

Power Measurement	RS232	USB
Power log period	20 sec to 600 hours for both	
Max points stored onboard per file ⁽¹⁾	5,400	5,400
Max points direct to PC file in real time	unlimited	unlimited
Energy measurement	RS232	USB
Max real time data logging rate ⁽²⁾	>30Hz	>2000Hz
Max onboard data logging rate ⁽²⁾	4000Hz	4000Hz
Data transfer from instrument to PC	~500 points/s	>1000 points/s
Max points stored onboard	59,400	59,400

(1): Can store up to 10 files for a total of 54,000 points.

(2): The above refers to the rate for logging every single point. Above that rate the instrument will sample points but not log every single point.

4.5 Energy Measurement

4.5.1. Setup

Switch the Nova II on. If it is in power mode, press the left soft key "energy" to put it into energy mode.

The energy mode is manual ranging: enter "range" and then use the navigation keys to get to the proper range then enter again. The correct range is the lowest one which is larger than the pulse energy measured. If you plan to use the same setting often, use the "configure" function as described in Section 4.3 before switching the Nova II off the first time. When the Nova II is switched on again, it will automatically go into the same range until a different configuration is saved.

Note:

The present range is displayed on the upper left and bottom right of the energy measurement screen as shown in Figure 4.6.

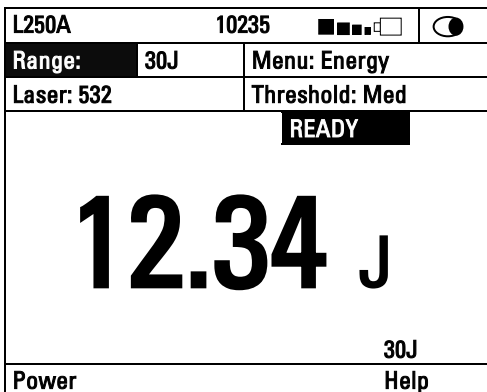

Figure 4.6
Thermopile Energy Screen

4.5.2. Measurement

To measure energy of a single pulse, set up as above and fire the laser. The display will go blank while the energy is being integrated. After 2-4 seconds, the correct energy will be displayed. When the Nova II is ready to measure a new pulse, "ready" will appear on the screen and flash on and off. (See Figure 4.6). The next pulse will automatically blank the screen, and the new value will be displayed. If you fire another pulse before "ready" appears, the reading may be inaccurate or may not be displayed.

4.5.3. Minimum Energy Threshold

If the Nova II is used in a noisy environment or where there is a high level of background thermal radiation, the instrument may trigger spuriously on the noise or background radiation. It would then fail to measure the intended pulse. Since there is always some degree of noise or background radiation, the instrument is

designed not to respond to pulses below some preset minimum size. This "Minimum Energy Threshold" is typically set to 0.3% of full scale of the selected range. If this level is found to be too sensitive for the user's particular environment, it may be altered by the user. The threshold should not, however, be raised higher than necessary. This will cause a degradation in the accuracy of energy measurements of pulses below about 4 times the threshold level. The factory setting of energy threshold is "med" for medium. If the unit triggers on noise, set the threshold to "high." If you are measuring small energies and the unit does not trigger, set the threshold to "low."

To set the energy threshold:

1. From the energy measurement screen, enter "threshold".
2. Select "high," "medium," or "low" threshold. For some 3A-P models, "optical" is also available and is the default choice (See below).
3. Enter again to return to main measurement screen. If you wish to save this value, press "save" before exiting. (See also section 4.3).

4.5.4. Measuring Pulses of Very Low Energy

When it is necessary to measure pulses of very low energy, i.e., less than 0.5% of the maximum range of the instrument, the following two alternative methods allow greater accuracy to be obtained.

1. A continuous train of pulses may be fired, and the average power measured using "power" mode. The energy per pulse can be calculated by:

$$\text{Average Energy per pulse} = \text{Average power} / \text{Pulse Repetition Rate}$$

2. A train of a known number of pulses may be fired, and the total energy measured in "energy" mode. This train should not exceed 5 seconds duration.

The energy per pulse can be calculated by: Average Energy per pulse = Total Energy / Number of Pulses

In both of the above methods, the pulse repetition rate must exceed 3Hz. Higher rates will generally give improved accuracy, but care should be taken not to exceed maximum power ratings.

4.5.5. Measuring Energy of Rapidly Repeating Pulses

The standard Nova II will only measure individual pulses every 5 seconds or so. You can also calculate the average energy of rapidly repeating pulses by measuring average power on the power setting and using the formula:

Average Energy per Pulse = Average Power / Pulse Repetition Rate

For rapidly repeating pulses, you can use one of the Ophir pyroelectric sensors, as long as the pulse energies do not exceed the ratings of the pyroelectric absorbers. The pyroelectric sensors are compatible with the Nova II and just have to be plugged in to be used.

For higher pulse energies, you can use the Ophir model RP to measure both average power and exact individual pulse energy of the rapidly repeating pulses.

See your Ophir agent or sales representative for details.

4.5.6. Energy Log and Data Storage

See Figure 4.7

The Nova II has the option of displaying successive energy points in a scrolling vertical bargraph form. While measurements are being taken, the Nova II will record data. Up to 59,400 points are stored See section

4.4.2.6.1 for more information on data storage and handling.

Note:

For Thermopile sensors logging energy, there are no setup options.

4.5.6.1. To use the Nova II for graphical display of energy - regular mode

1. Make sure that the Nova II is in the correct energy measurement range. If not, enter "range", adjust and enter again.
2. From the energy measurement screen enter "menu" and then select "data-log". Now press "log" and the energy log screen will appear. Press "go". Now fire a pulse when the "ready" legend flashes. The measurement will immediately begin. When the screen is full, the display will scroll and the latest points will continue to be displayed. When the data register is full, "FULL" will be displayed. If you wish to see finer variations in the graph, press the "zoom" button.
3. When "reset" is pressed, the Nova II is ready to begin a new measurement. If you want to store the data before making a new measurement, see section 4.4.2.6.1 on data storage.

Warning:

Pressing "reset" will erase all previously stored data.

A statistical summary of the data on the screen is shown on the top. If you wish to permanently store the data in a file, press "enter" and then choose "yes" to enter the file system. See section 4.4.2.6.1 for further information.

Note:

Zoom can only be pressed after at least one pulse has been recorded.

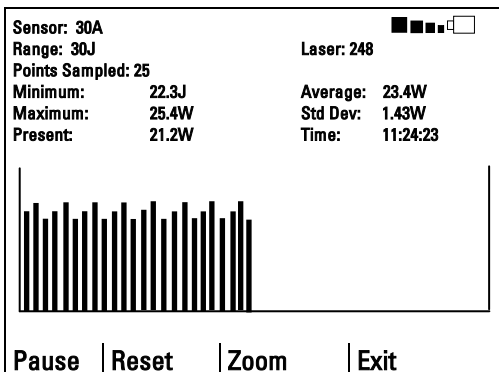

Figure 4.7
Energy Log Screen

4.6 Advanced Meter Screens

4.6.1. Power and Energy Beam Splitter/Attenuator Screens

If you have a measurement setup with a beam splitter or attenuator and wish to display the laser power or energy before the splitter or attenuator and not the actual value impinging on the measurement sensor the beam splitter function allows you to do this. For example, if you are splitting off 10% of a laser beam into the meter and you wish to display the full beam, do as follows:

1. From the main power or energy measurement screen, enter menu, select "attenuate" and enter again.
2. Enter "beam %" and then with the up down navigation buttons, select the first number. With the right navigation button go to the second number, and with the up/down navigation buttons select the second number and so on. For example, in the screen shown below, 10% has been selected. The large number shows the full beam power / energy impinging on the beam splitter and the small number the power/energy actually measured by the meter.

Press save if you wish to save this value and then press enter to return to the standard measurement screen.

If you want the instrument to start up in the attenuation screen, follow the instructions for instrument startup defaults in section 3.5.

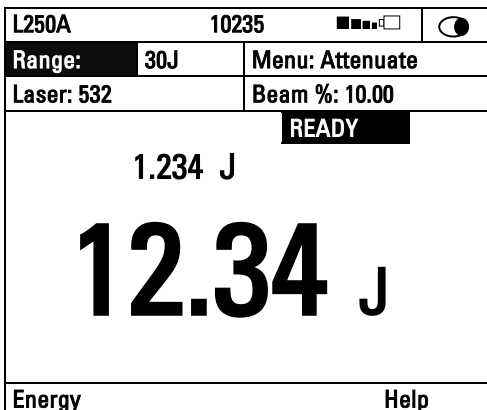

Figure 4.8
Attenuation Screen

Note 1:

The attenuator screen only affects the value displayed on that screen and nothing else. The power and energy scales remain the same, the damage thresholds remain the same etc. The attenuator screen is only an extra screen to show a different calculated number introduced by the user.

Note 2:

The attenuation value is stored in the Nova II and not the sensor so if it is set, any sensor connected will come up with the value chosen.

4.6.2. Power and Energy Density Screens

The Nova II gives you the option to measure in units of power and energy density instead of power and energy. You input the beam size and the meter then calculates

and displays the power or energy density in units of W/cm^2 or J/cm^2 . In order to activate this screen do as follows:

1. From the main screen select "menu" , enter and select "density".The display will now be in units of W/cm^2 or J/cm^2 depending if you were in the power or energy measurement screen.
2. The default setting is for round beams. If your beam is round continue on to perform steps 3-5. If your beam is rectangular perform steps 6-9.
3. Select "size" and you will see 4 default choices of beam diameter.
4. Select the beam diameter you wish to adjust and press the left navigation key.
5. Now modify by pressing the up/down navigation keys to change each number and the right/left keys to move to the next number. After you are finished, press "save" and enter.
6. Press "Rect" to switch to the rectangular mode.
7. Select "Height" and modify by pressing the up/down navigation keys to change each number and the right/left keys to move to the next number. After you are finished, press "save" and enter.
8. Select "Width" and modify in the same way.
9. The beam size will appear in the box above the "Height" box.

4.6.3. Power and Energy Limits Screens

The Nova II gives you the option to set upper and lower limits of power and energy. If these limits have been set in the limit screen, then when the power or energy is above the maximum limit set the message "OVER" will appear on the screen and when under the minimum limit set, the message "UNDER" will appear on the screen.

To set up the limits screen do as follows:

1. From the main power or energy screen press "menu", select "limits" and enter.
2. Select "low" and enter. Now enter the low limit value by pressing the up/down navigation keys to

change each number and the right/left keys to move to the next number. After you are finished, press “save”.

3. Do the same for the “high” limit.
4. If you want the limits screen to be the startup default of the Nova II, follow the instructions in section 3.5.

Now when the power or energy is over or under the limits chosen, the error message will be shown as in Figure 4.9. Note that the lower limit is shown on the upper left and the upper limit on the upper right.



PE50		10235		 	
Range:	200 μ J	Menu: Limits			
Laser:	532	Average: 1 sec			
Low:	100.0 μ J	High: 150.0μJ			
<p>UNDER</p> <p>62.3μJ</p>					
Energy			Help		

Figure 4.9 Limits Screen

Other Types of Sensors

The functions described in the sections above can be used with photodiode and pyroelectric detectors as well.

4.6.4. Position and Size

Some thermopile sensors are capable of Position and Size measurement of laser beams. For a full description, please see [Chapter 7 BeamTrack Features](#)

Chapter 5. Operation with Photodiode Type Sensors

Warning:

Before using the sensor for power measurement, check that your laser power or energy and energy density does not exceed the sensor ratings. See Table 5. and Table 6. in Chapter 10.

5.1 Photodiode Sensors

When a photon source, such as laser, is directed at one of the PD300 or 3A-IS series photodiode detectors, a current is created proportional to the light intensity and dependent on the wavelength.

The PD300 and PD300-3W sensors have a unique dual detector sensor (patented) in which the two detectors are identical and connected back to back. When a uniform signal, such as room light background, falls on the detector sensor the signal from the two detectors cancels.

On the other hand, when a laser beam falls on the sensor, it illuminates only the first detector and therefore is detected. Thus the PD300 subtracts most of the background while detecting the desired signal. The subtraction is not perfect but usually 98% of the background signal is eliminated so the detector can usually be used in ordinary laboratory lighting conditions.

The Nova II meter amplifies this signal and indicates the power level received by the sensor. Due to the superior circuitry of the Nova II, the noise level is very low, and the PD300 /3A-IS series sensors with the Nova II meter have a large dynamic range from nanowatts to hundreds of milliwatts.

Since many low power lasers have powers on the order of 5 to 30mW, and most photodiode detectors saturate at about 2mw, most sensors of the PD300 series have

been constructed with a built in filter so the basic sensor can measure to 30mW or more without saturation. When the additional filter is installed, the maximum power is on the order of 300mW (or 3W with model PD300-3W). The PD300 saturates when the output current exceeds 1.3mA so the exact maximum power depends on the sensitivity of the detector at the wavelength used. When saturated, the legend "OVER" will appear on the screen. Table 2. gives the actual maximum power as a function of wavelength.

Filter Out

Wave Length	PD300	PD300 -TP	PD300 -3W	PD300 -UV	3A-IS	Wave- Length	PD300 -IR	PD300 -IRG
250-350nm	N.A.	N.A.	N.A.	3mW	N.A.	800nm	12mW	0.8mW
400nm	30mW	3mW	100mW	3mW	N.A.	1-1.3µm	30mW	0.8mW
633nm	20mW	2.5mW	100mW	3mW	1W	1.4µm	30mW	0.8mW
670nm	13mW	2mW	100mW	3mW	2W	1.5µm	25mW	0.8mW
800nm	10mW	1.5mW	100mW	2.5mW	3W	1.6µm	30mW	0.8mW
900nm	10mW	1.5mW	100mW	2.5mW	3W	1.8µm	30mW	N.A.
1060nm	25mW	3mW	100mW	3mW	3W			

Filter In

Wave Length	PD300	PD300-TP	PD300-3W	PD300-UV	3A-IS	Wave Length	PD300-IR	PD300-IRG
250-350nm	N.A.	N.A.	N.A.	300mW	N.A.	800nm	0.8mW	100mW
400nm	300mW	1W	3W	300mW	N.A.	1-1.3µm	0.8mW	30mW
633nm	300mW	1W	3W	300mW	1W	1.4µm	0.8mW	150mW
670nm	200mW	500mW	2W	300mW	2W	1.5µm	0.8mW	150mW
800nm	100mW	300mW	1.2W	150mW	3W	1.6µm	0.8mW	150mW
900nm	150mW	300mW	1.2W	150mW	3W	1.8µm	N.A.	N.A.
1060nm	250mW	500mW	2.2W	300mW	3W			

Table 2.

Maximum Measurable Laser Power as a Function of Wavelength

5.2 Setting up the PD300 to display the user's chosen wavelengths

The PD300 series has built in wavelength correction curves for measurements either with the removable filter installed (filter-in) or removed (filter-out). These curves are stored in the sensor EEROM. The correction curves, with a resolution of 1nm, ensure that the power reading is correct at all laser wavelengths.

In order to simplify changing from one laser wavelength to another, the user can program up to 6 different wavelengths to be available from the screen menu.

Please use the following procedure to set the PD300 to your laser wavelengths.

1. From the power measurement screen, select "laser" and enter.
2. With the up/down navigation keys, select the first wavelength desired. Press the right navigation key to enter the change wavelength screen.
3. Now enter the wavelength value by pressing the up/down navigation keys to change each number and the right/left keys to move to the next number. After you are finished, press "save" and enter.
4. Repeat steps 2 and 3 for other wavelengths desired. When finished press enter. Those values for which "save" was pressed will be default startup values, the others will be saved until the instrument is turned off.

5.3 Startup Defaults

If you are planning to do similar measurements most of the time, you can set up the Nova II so that it automatically goes into the measurement mode you want upon startup. Since these desired settings are saved in the sensor "smart connector", you can save different settings for different sensors. The following section describes how to set up the Nova II with the PD300 sensor so that it will start up in the desired configuration.

Setting up the startup defaults: (See section 5.4 for further details)

1. With the sensor connected, turn on the Nova II. Select "menu" and enter. Select "configure" and enter.
2. Select "filter" and enter. Select in or out as the startup default and enter. For details of filter in/out See Section 5.4.3.
3. Now select "display mode" and select the desired startup screen. Press save.(Note that this selection is saved in the Nova II and not the sensor so will be

operative for all sensors). For more details on the screen types see section 4.6.

4. Now select "Power Range:" and in the same way choose the manual power range you wish to be the default or autorange or dBm. The Nova II will now be in the range selected when switched on with the sensor in question.
5. Now select "average" to choose the averaging period for power measurement. If you do not want averaging, choose the value "NONE" See section 4.4.2.4 for details about averaging.
6. Now select "laser" and use the value button to select the default startup wavelength and save.
7. If you want to change the choice of wavelengths select laser and press the right navigation key. Enter the wavelength value by pressing the up/down navigation keys to change each number and the right/left keys to move to the next number. After you are finished, press "save" and "enter".

5.4 Selecting Settings from the Nova II Screen

The Nova II can conveniently be set to various chosen parameters from the screen. In addition these settings can be saved as startup defaults so the sensor will be in the desired configuration when turned on.

5.4.1. To Set to the Laser Wavelength Being Used

Photodiode sensors have a different sensitivity at different wavelengths. Moreover, the filters used in the sensor have a different transmission at different wavelengths. In order to compensate for this, each sensor has a built in calibration curve (with 1nm resolution) over the measurement range.

When you choose the correct laser wavelength, the correction factor for that wavelength is automatically introduced. Note that the laser wavelength presently corrected for is displayed in the upper left corner of the display. In order to define the laser wavelengths to choose from, See Section 5.2.

In order to choose the laser wavelength, simply select "laser" and enter. Select the chosen wavelength and enter again. In order to set the default startup wavelength, see section 5.3.

5.4.2. To choose Manual or Automatic Ranging or dBm

Autorange - The Nova II allows you to choose autorange or manual ranging when the reading is in watts. In autorange mode, you do not have to change scales. When the reading of the meter or bar is more than 100% of full scale, the range goes to the next higher one. When the reading falls below 9% of full scale, the range changes to one range lower. This change occurs after a short delay. This provides overlap (hysteresis) to keep the Nova II from flipping back and forth when reading close to the end of the scale.

Manual Range - There are certain disadvantages to autorange since it changes scale even if you don't want it to do so. If you want to measure the same range all the time, it is better to use manual range. The correct range to select is the lowest one that is larger than the largest expected measurement. If you wish the Nova II to be in manual mode when switched on, save this configuration before switching off. See Section 5.3.

dBm - The Nova II allows the measurement to be made in units of dBm that is a logarithmic scale. dBm units are defined as:

10 x log (reading in mW)

At 1mW the reading will be 0 dBm, at 100mW it will be 20 dBm etc.

To choose auto, manual or dBm range, follow these steps:

1. From the main measurement screen, select "range".
2. Now select the correct manual, auto or dBm range with the navigation keys. If you want the selected range to be the startup value press "save" or by pressing the enter key to return to the measurement screen.

5.4.3. Operation with Filter In or Out

The PD300 sensor is equipped with a built in filter so that the photodiode can measure up to 30mW without saturating the detector. In addition, the PD300 comes with an additional removable filter for measuring up to 300mW. Other models of the PD300 series also have built-in and removable filters. The exact maximum power is reached when the reading reaches full scale or the output current from the sensor reaches 1.3mA, whichever comes first. See Table 2 for the exact maximum as a function of wavelength.

Depending on what powers you wish to measure, you should choose whether or not to work with the removable filter installed or not. For this purpose, the Nova II has a "filter" setting and uses the proper correction curve depending on whether the filter is installed or not.

Warning:



If the PD300 is used in the "filter in" setting and the filter is not installed or vice versa the readings will be completely incorrect.

If the power of your laser exceeds the maximum for filter in, you can purchase a thermal or integrating sphere sensor for that wavelength. Consult your Ophir agent for details.

To choose the filter setting:

1. From the main measurement screen press "filter".
2. If you wish to work with filter installed, press "change" until display says "filter is in". Be sure to install removable filter on detector sensor.
3. If you wish to work with the filter out, press "change" until display says "filter is out". Be sure to remove the filter from the detector sensor.
4. When finished press "OK" to return to the measurement screen.

Note:

The filter status can be seen at a glance on the screen: filter out will be shown by  and filter in by .

5.4.4. Zoom

The Zoom function causes the scale to expand around the present reading $\pm 20\%$. Thus, if the full scale of the bargraph is 20mW and your reading is 15mW, pressing "zoom" will make the bargraph scale range between approximately 12 and 18 mW. Variations in power are more easily seen in this mode. When zoom is engaged, the legend is highlighted. To cancel the zoom function, press "zoom" again. The zoom function can be useful for laser power tuning and peaking.

To access the zoom function, press "zoom". When it is highlighted it is engaged. Note that the fiducial marks of the bargraph are further apart, indicating that zoom is engaged. Pressing "zoom" again will cancel the function.

5.4.5. Offset

The PD300 and PD300-3W sensors have automatic background subtraction as described in Section 5.2. In addition, the offset function can be used to subtract the residual background signal that remains if desired. If the Nova II shows a nonzero power reading even when there is no laser, you can subtract the background

using the zero function. For example, the Nova II display reads 0.1mW when the laser is blocked and 20.5 mW with laser power applied. In this case, the true power is $20.5 - 0.1 = 20.4$ mW. To subtract the background, press "offset" while the laser is blocked. The Nova II will now read zero (0.0), and the 0.1 mW background will be subtracted from all subsequent readings. The laser power reading will thus be 20.4 mW.

When "offset" is engaged, the legend is highlighted. To cancel, press "offset" again. If the "offset" is engaged, and you wish to subtract a new value of the background, press "offset" twice. The first press will cancel the old value, and the second will activate a new value. If you suspect that the Nova II has a permanent zero offset, then disconnect the sensor while it is in the power measurement mode.

5.4.6. Measuring loss using the dB offset function

Since dBm is a logarithmic measurement, the ratio between two measurements will be the difference between the dBm measurements. For instance, if you want to measure the loss in a fiber optic cable where the measurement before the cable is 1mW = 0dBm and the measurement after the cable is 0.1mW = -10dBm. The ratio is then $1:10 = 0.1$ and the dB loss is $0 - (-10) = 10$ dB.

The dB offset function allows you to easily measure this. To do so do as follows:

1. When measuring the reference value press "dB-0". The value changes to 0 dB (note that now the units are dB, a relative value instead of dBm, an absolute value).
2. Now make your second measurement and the value of the difference in dB = ratio in numerical units will be shown.

Note:

If there is a zero offset in the reference value, you cannot subtract this using the dB offset function. Instead, before the start of the measurement, press "offset" and subtract the zero offset. Then follow steps 1 and 2 above. The zero offset subtracted when "offset" was pressed will be saved in the dBm scale and you can now use the dB-0 setting to measure true ratio without zero offset problems.

5.4.7. Average and Measuring Very Low Power Measurement

If the laser power is fluctuating, the Nova II can display the average power readings with averaging periods varying from 1s to 1 hour. When measuring very low powers, such as picowatt measurements using the PD300-IRG or PD300-UV, there will be a rather large zero offset coming from the detector as well as a considerable noise fluctuation. Nevertheless, you can measure these low values by using the average function and pressing offset to eliminate the detector zero offset. In order to measure very low powers do as follows:

1. Select "menu", enter and select "configure". Choose the appropriate value you want to average over and save it and then exit.
2. Now block the power source you wish to measure, wait for a few measurement periods and press "offset" to subtract the zero offset.
3. Now unblock the power source and measure. For more about the average function See Section 4.4.2.4.

Note:

The average function does not work with autorange or dBm scales.

5.4.8. Tune and Power log

The Tune function, an exclusive Ophir option, makes adjusting your laser to its maximum power easier than ever before. Unlike a bargraph or mechanical meter, this display shows graphically what came before as well as the current reading and the trend. This allows you to see at a glance if you have reached maximum power.

The Nova II also has the option of graphing the laser power vs. time, or successive energy points as long as the Nova II has not been turned off. While measurements are being taken, the Nova II will record data until the screen is full, or "reset" or "exit" is pressed.

If the laser power is fluctuating, the Nova II can also display the average power readings with averaging periods varying from 1s to 1 hour.

These functions are the same for thermal type sensors and for photodiode sensors. See Section 4.4.2.3 for details.

Chapter 6.

Operation with Pyroelectric Sensors

Warning:

Before using the sensor for power or energy measurement, check that your laser power, energy and energy density do not exceed the sensor ratings as listed in the table with the sensor specifications. Otherwise, there is a risk of damaging the absorber.

With the pyroelectric sensor, you have been supplied a test slide with the same coating as on your pyroelectric detector. You can also obtain this slide from your dealer. You should use this slide to test the damage threshold with your laser pulses. If the slide is damaged, then either enlarge your beam or lower the laser energy until damage is no longer seen.

6.1 Pyroelectric & Photodiode Energy Sensors

6.1.1. Pyroelectric sensors – method of operation

When a pulsed heat source, such as a laser, is directed at the detector sensor, a temperature gradient is created across the pyroelectric crystal mounted in the sensor. An electric charge is produced which is proportional to the energy absorbed. The detector sensor has sophisticated circuitry unique to Ophir (patented) that determines the baseline before the pulse is received, measures the voltage after a pre-determined interval, amplifies it and holds it for a pre-determined time.

Due to this innovative circuitry, Ophir pyroelectric sensors can measure very long pulses as well as short ones. They can measure low energies as well as high. They can also measure at higher repetition rates than was possible before.

The Nova II meter amplifies this signal and indicates the energy received by the sensor as well as the

frequency at which the laser is pulsing. Using the energy and frequency information, the Nova II is also able to display average power.

The photodiode based PD10 & PD10-PJ sensors also use the same circuitry but can measure much lower energies due to the sensitivity of the photodiode.

6.1.2. Photodiode energy sensors – method of operation

The PD10 & PD10-PJ operates in a similar fashion to the pyroelectric PE sensors except it has a photodiode detector instead of pyroelectric. Because of its great sensitivity, it can operate down to about 1nJ of energy. It has complete wavelength correction over its entire measurement range of 200 - 1100nm.

The PD10 & PD10-PJ operates in a similar fashion to the PE sensor except that it has one extra function. When measuring very low energies, the sensor will also be sensitive to background light and therefore show a spuriously high reading. Therefore we have added a function to measure the background light. When measuring low energies, block the laser and press "bkgrnd".

You will see a reading of the background light. This reading can be subtracted from your laser reading to obtain a more accurate reading. Also, making the room darker will reduce this background effect.

6.2 Selecting Settings from the Nova II Screen

The Nova II can conveniently be set to various chosen parameters from the screen. In addition, it can be set to startup defaults so it will be in the desired configuration when turned on.

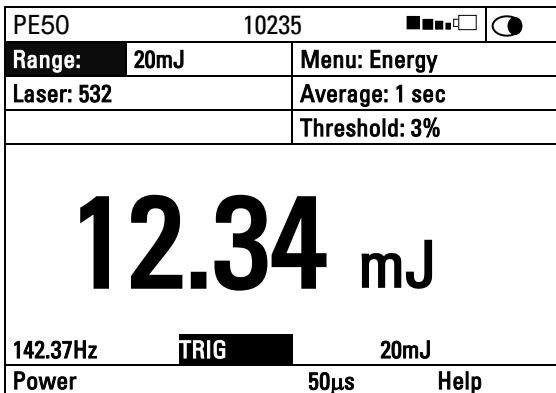

Figure 6.1
Pyroelectric Energy Screen

6.2.1. Setting up the sensor to display the user's chosen wavelengths.

The absorption of the detector coating varies somewhat with wavelength. The correction curve for the absorber is stored in the sensor EEROM. This correction curve ensures that the power reading is correct at all laser wavelengths.

In order to simplify changing from one laser wavelength to another, the user can program up to 6 different wavelengths to be available from the screen menu. Please use the following procedure to set the pyroelectric or PD10 & PD10-PJ sensor to your laser wavelengths.

1. From the main display, select "laser" and enter.
2. Use the up/down navigation keys to select the first wavelength desired. Press the right navigation key.
3. Now enter the wavelength value by pressing the up/down navigation keys to change each number and the right/left keys to move to the next number. After you are finished, press "save" and "enter".
4. Repeat step 3 for other wavelengths desired. When finished press "enter". Those values for which "save" was pressed will be default startup values,

the others will be saved until the instrument is turned off.

5. Pyroelectric sensors are sensitive to vibration as well as heat from the laser pulses. If there is vibration or excessive acoustical noise at the measurement location, the sensor can trigger even with no laser pulses. If this occurs, set the threshold to a high enough value that

Note:

The BB type sensors have less variation with wavelength, and in those sensors, fixed wavelength ranges are selected similar to thermal sensors. This section is not relevant with those sensors.

6.2.2. Setup of Laser Pulse Width and Pulses/Sample

6.2.2.1. Laser Pulse Width

As was mentioned before, the Ophir pyroelectric sensors can measure long as well as short pulses. In order to operate properly, the Nova II must be set to a maximum pulse width setting longer than the actual laser pulse width. Therefore the pulse width should be set to the shortest pulse width longer than the actual laser pulse width. (Some sensors only have one pulse width setting and measure all pulse lengths on this setting In that case "N/A" will appear).

Warning:

If the pulse width is incorrectly set to a pulse width shorter than the actual pulse width of the laser, the reading will be erroneously low. If it is set to a setting longer than necessary, the reading will be correct but noisier.

To set up for pulse width, please do the following:

From the main measurement screen, press the 3rd from the left soft key. The choices of maximum pulse width will appear. With the navigation keys, select the smallest value larger than your actual laser pulse width and press "save".

6.2.2.2. Setup for the Time Period to Average Over

The Nova II has the ability to measure a number of pulses and display the average value of the energy of the pulses. This function is useful if the laser energy is not stable. Then the user can choose to measure a number of pulses and display only the average.

To set up for averaging over a number of pulses:

1. From the main measurement screen, select "menu" and enter. Select "configure" and enter.
2. Now select "average" and enter. Select the time period you wish to average over and enter. If you do not want to average, but collect individual pulses then select "none".
3. If you wish to save the new setting as the default, press "save" before enter.

Note:

The Pyroelectric sensor is capable of measuring pulses up to very high repetition rates on the order of kilohertz or above. The Nova II actually captures each pulse up to 4000Hz and will sample pulses at up to 25,000 pulses depending on the sensor. The pulses collected can be stored for later recovery and transmission. (See section 4.4.2.6.1). However, the display can only display at rates up to 15Hz. At higher rates, if the user has chosen "NONE", the Nova II will display individual pulses sampled at a rate of 15Hz. If the user has chosen to average over a time period, the instrument will display the average of readings over the period from the time the screen was entered up to the present. For instance, if the average period is 30 seconds, at 15 seconds, the average is over 15 s., at 30 seconds it is over 30 seconds, at 5 minutes, it is over the period from 4.5 to 5 minutes (30 seconds back from the present etc.).

6.2.2.3. Setting the Threshold (PE-C sensors)

Pyroelectric sensors are sensitive to noise and vibration as well as the heat from the laser pulses. They can falsely trigger on such disturbances, especially on the lowest ranges. The PE-C series of sensors has a user settable threshold to suppress such false triggering. The default threshold setting is set to 3% of full scale. However, it can be set to smaller or larger values. If you are measuring very low energies, for highest accuracy, it is recommended to set the threshold to the minimum value, as long as this does not result in false triggering. For noisy environments with false triggering, it is recommended to set the threshold to the lowest value that eliminates the false readings. You can change the threshold as follows:

1. With the navigation buttons select "threshold" on the main measurement screen. Enter.
2. Now with the up/down navigation buttons select the desired threshold.
3. If you want to change the threshold but not save the new value permanently press enter, if you want to save the new value as the default start up for this sensor, press "save".

6.3 Startup and Configuration of Defaults

If you are planning to do repetitive measurements most of the time, you can set up the Nova II so that it automatically goes into the measurement mode you want upon startup. Since these desired settings are saved in the sensor "smart connector", you can save different settings for different sensors.

To set the Nova II startup mode and to save the chosen Nova II configuration:

With the sensor connected, switch on the Nova II. Select "power" or "energy" measurement screen. Select "Menu" with the navigation keys. Enter, select

"configure" and enter again. Now choose the desired startup parameters as follows:

1. Select "startup mode" to choose "power" or "energy" for the desired startup screen. Choose power or energy and press enter and save. The Nova II will now start up in power or energy measurement mode, respectively, when switched on.
2. Now select "display mode" and select the desired startup screen. Press save. (Note that this selection is saved in the Nova II and not the sensor, so will be operative for all sensors). For more details on the screen types see section 4.6.
3. Now select "Energy Range" and choose the energy range you wish to be the default or autorange. The Nova II will now be in the range selected when switched on with the sensor in question. Note that there are only manual ranges in energy.
4. Now select "Average" and select the period you wish to average power readings over. This feature is especially useful for lasers with non-steady output. See section 4.4.2.4 for details.
5. Now select "Diffuser" if your sensor has a removable diffuser and select if you wish diffuser in (installed) or out (not installed) to be the default.
6. Now select "Max Pulse len", enter and select the laser pulse width. Select the shortest value longer than your laser pulse width and press save.
7. Now select "Laser" and select the laser type you want to be the default. The Nova II will now be correctly calibrated for the absorption of the detector at the wavelength of the laser type selected and will startup with the laser wavelength selected.
8. Now press "save" if you want this to be the startup default and press "exit".
9. Switch the Nova II off then on by means of the on/off/backlight switch. (See Figure 3.1). The Nova II will enter the mode of operation last saved with the "configure" operation.

6.4 Energy, Power or Exposure Measurement

Warning:

Before using the sensor for power or energy measurement, check that your laser energy, energy density and average power do not exceed the sensor ratings as listed in the table with the sensor specifications at the end of the manual, otherwise, there is a risk of damaging the absorber. With the pyroelectric sensor, you have been supplied a test slide with the same coating as on your pyroelectric detector. You can also obtain this slide from your dealer. You should use this slide to test the damage threshold with your laser pulses. If the slide is damaged, then either enlarge your beam or lower the laser energy until damage is no longer seen.

Note:

To measure pyroelectric energies properly, it is important that the sensor is not grounded to the optical bench. Make sure that the sensor is isolated electrically from the ground. The PE sensor has been supplied with an insulating mounting post for this purpose.

6.4.1. Energy Average Power and Frequency Measurement

Unlike most pyroelectric energy meters, the Nova II measures the pulse frequency to a high degree of accuracy and is therefore able to display pulse frequency and average power as well as pulse energy. The following paragraph will describe how to set up and measure these functions.

6.4.1.1. Zeroing Sensor against Nova II Meter

There is a slight variation of pyroelectric reading from meter to meter. Therefore, for most accurate pyroelectric energy measurements it is necessary to zero the pyroelectric sensor against the Nova II meter it will be used with. After this is done, the

sensor is “conditioned” to work with the particular Nova II the zeroing was done against. It is not necessary to do this procedure again unless the Nova II is used with a different sensor. If the procedure is not done, errors of 2% or so can occur. To zero the sensor against the Nova II, proceed as follows:

Make sure the sensor is in a quiet environment and not subject to pulsed radiation. Plug the sensor into the Nova II and turn on. Select “menu” and enter. Select “zero” and enter. Press “start”. When “zeroing completed” appears, press “save”, and “exit”.

6.4.1.2. Energy Measurement

1. Ordinarily, when the instrument is switched on, it is in the main energy measurement mode. This can be verified by the units of mJ, μ J etc. and the legend “energy” in the upper right corner of the display. (See Figure 6.1). If it is in power measurement mode with units of mW, W etc., then press “energy”.
2. Enter “range” and select the proper range. The correct range is the lowest one that is larger than the pulse energy measured. If you want this to be the default, press “save” or return to main screen by pressing the “enter” key.
3. Press the menu button, select “configure” and press “enter”. Select “Max Pulse Len” and “Diffuser” if applicable and set to the correct value for your laser. (See section 6.2.2.1 for further details on laser pulse width).
4. If you wish to display the average of a number of pulses, select “menu”, enter and select “configure” and enter again. Select “average” and set to the value desired. The default value is “none” which means that the pulses displayed are individual pulses with no averaging. See section 6.2.2.2 for further information on averaging.

The Nova II is now ready to measure energy pulses. The energy reading will operate in the following manner

if "none" selected as the averaging period, following every 1/5th of a second period, the Nova II will display on the screen the next pulse which arrives. The Nova II will hold the display of the latest pulse until a new one arrives. If an averaging period is selected, the Nova II will collect pulses at up to 180Hz and will then display the average of those pulses. When a new pulse triggers the Nova II, "TRIG" will appear on the screen. At over 5Hz, the "TRIG" stops flashing and appears all the time.

Note 1:

If the sensor is triggering false readings from vibration or noise, with PE-C sensors you may set the threshold to a higher value. If you are measuring very low energies, you may set the threshold to a lower value for more measurement accuracy. See section 6.2.2.3 for details.

Ophir also offers a shock absorbing mounting post (P/N 7Z08268) that helps reduce vibration on the sensor.

Note 2:

The Nova II is able to record each pulse at up to 4000Hz even though it is displaying at a much lower rate. This data can be stored in a data file and recovered and transmitted later.

Besides the usual range, laser, average information, the Nova II also displays the frequency of the laser as shown in Figure 6.1.

6.4.1.3. Power Measurement

1. Make sure the instrument is in the power measurement mode indicated by the units of mW, W, etc. If it is in energy measurement mode with units of mJ, μ J etc., then press the "power" soft key. The Nova II can be configured to start up in power measurement mode when turned on. See section 6.3.

2. Select "range", enter and then use the navigation keys to select the proper range. The correct range is the lowest one that is larger than the pulse energy measured. Note that the proper range is related to the pulse energy even though we are measuring average power.
3. Press "enter" to return to the measurement screen. If you want this to be the default range, press "save" before pressing "enter".

6.4.2. Measuring Total Energy Exposure.

The Nova II has the ability to sum the total energy of a number of pulses over a given time period or number of pulses. This gives the total energy "exposure" over that time period. For example if the laser is pulsing at 30 times/sec at 1mJ per pulse and you measure the exposure over 20 seconds then the total exposure is $30 \times 1 \times 20 = 600\text{mJ}$

In order to measure exposure, do the following:

1. From the energy measurement screen, select "menu" and enter. Select "exposure" and enter.
2. Setup the desired measurement parameters as follows:
 - Timeout: Use this if you want to measure over a specific time period independent of the specific time period.
 - Pulses: Use this if you want to measure over a specific number of pulses.
 - Mode: Choose "after timeout" if you want to measure over a specific time period
Choose "after pulses" if you want to measure a specified number of pulses.
Choose "manual only" if you want to stop the measurement manually only. (Note that you can also stop the measurement manually in the other modes as well).



PE50		10235			
Range:	20mJ	Menu: Exposure			
Laser:	532	Mode: PULSES			
Pulses:	20	Timeout: 10 sec			
<h1>12.34 mJ</h1>					
Elapsed 00:00:05.3	TRIG		Pulses 100		
Energy	Stop	Reset	Help		

Figure 6.2.
Exposure Screen

3. Press "start". The Nova II will start summing laser energy exposure. When you wish to stop measuring, press "stop" or wait for measurement to reach the "timeout" or the "pulses" selected in the setup screen. The Nova II will now display the total energy emitted during that period, the time elapsed and the number of pulses during the period. If you wish to reset reading to zero before another reading, press "reset".
4. To return to the regular energy measurement screen, press "energy".

Warning:

Pressing "reset" will erase all previously stored data.

A statistical summary of the data on the screen is shown on the top. If you wish to permanently store the data in a file, press exit and then choose "yes" to enter the file system. See section 4.4.2.6.1 for further information.

Normalize

When you wish to show the readings as compared to some standard reading, the normalize function allows you to do this. After setting "normalize", all subsequent readings will be shown as a ratio to the reference reading. For instance, if you normalize the reading at an energy of 1.5mJ, then subsequent readings will be with ratio to that, i.e. if the energy at that point is 2mJ, the reading (dimensionless) on the screen will be $2/1.5 = 1.33$. The screen will also show in small digits the energy at which the normalization was done and the present energy

To use the Nova II to normalize the energy:

1. From the main measurement screen, enter "menu" and select "normalize".
2. When ready to normalize, press "apply". From then on, the energy will be proportional to the normalized energy value. (See Figure 6.3).
3. If you wish to return to the the regular display, press "energy".

Note that in "present" is shown the last power or energy reading, in "reference" is shown the reference value we are normalizing to and in the large number, the ratio.



PE50	10235		
Range:	20mJ	Menu: Normalize	
Laser: 532	Average: 1 sec		
Present:	1.70mJ		
Reference:	1.90mJ		
0.895			
Energy	Reset	Help	

Figure 6.3
Pyroelectric Normalize Screen

6.5 Measuring Repeating Pulses of High Energy

Because of their construction, pyroelectric sensors are restricted in the energy density they can withstand, particularly for short pulses on the order of nanoseconds. If the energy density of your laser exceeds the rating of the pyroelectric absorber, there are several options available:

1. You can enlarge your laser beam using a negative lens until the energy density is below damage threshold. You should test this using the test slide. See section 4.6.
2. You can use a beam splitter, splitting off typically 8 - 10% of the light. If you use this method, note that there may be polarization effects. You can calibrate the beam splitter by running the laser at an energy below damage threshold and measuring the energy with and without the beam splitter and you can then use the normalize function above to display the actual laser power or energy.
3. Ophir has three sensors specifically designed for high energy density pulses. They are the PE50HD sensors with high damage threshold, the PE50-DIF model pyroelectric sensors with a diffuser and the RP thermal/photodiode sensors. Some of these sensors can measure energy densities up to several Joules/cm².

Contact your Ophir dealer for details.

6.6 Energy Log

This is the same as for thermal sensors, except you do not have to wait for "reset". See sections 4.5.6 and 4.4.2.6.1

Note:

For Pyroelectric sensors logging energy the only setup option is 'sample rate'. The user can choose the number of pulses he wishes to log - from 'every pulse' to '1 out of 1000' pulses - but not the time period.

Turbo mode

In regular data log mode above, you can only log every point at up to 180 points per sec. Also you can not transmit to PC at higher rates than 180 Hz in regular data log mode.

In order to log data or transmit it to PC at rates >1000Hz, you must be in turbo mode. This will put you into a special mode where the Nova II can handle data at high speed while curtailing other functions. To log in turbo mode, do as follows:

1. Make sure that the Nova II is in the correct energy measurement range. If not, press "range", adjust and "exit".
2. From the energy measurement screen press "menu" and then select "data log".
3. With the up/down navigation buttons, indicate the appropriate laser, graph settings and frequency. Then choose the log size, i.e. how many points you want to log. Now press "turbo" and "go". The measurement will begin and the Nova II will indicate when the file is full.

Note1:

The Nova II does not measure frequency in turbo mode. Therefore you have to indicate the frequency before starting the measurement. This means you cannot measure pulses with frequencies which vary during the measurement run.

Note2:

The Nova II will not respond to any buttons until the turbo logging session is over. This applies either for data logging or data transmission in turbo mode. See section 4.4.2.6.1 for further information.

6.7 Pyro Scope Adapter

A special adapter can be purchased which is plugged in between the sensor connector and the Nova II sensor socket. This adapter has a cable and BNC connector to attach to an oscilloscope. It enables the user to see on the scope pulses proportional to energy up to the maximum pulse rating of the sensor. Unlike the Nova II meter, which samples at the maximum rate, the scope adapter shows every single pulse.

Activate the scope adapter as follows:

1. Plug the adapter into the Nova II meter and then plug the sensor plug into the adapter. Plug the BNC connector into a standard $1M\Omega$ scope input.
2. Enter power or energy "menu" and select "scope". The display will now say "in scope mode". Select the appropriate measurement range and laser wavelength in the usual way.
3. You can return to the ordinary measurement mode by pressing "energy"/ "power" from the scope mode screen.

6.8 PE-DIF Diffuser Sensors

Setting up PE-DIF diffuser sensors to diffuser IN or OUT setting:

1. In the "Configure" screen set "Diffuser" to be "IN" or "OUT" according to the startup mode you prefer.
2. Go to the main power / energy screen.
3. "IN" (or "OUT") appears at the bottom of the screen (next to the second button from the left). Make sure the diffuser is physically installed (or not installed) on the sensor respectively.
4. To change from "IN" to "OUT" press "IN" (the statement "Diffuser is IN" will appear). Press "Change" (the statement "Diffuser is OUT, Ensure that diffuser is removed from sensor" will appear)

5. Press "OK" and "OUT" will appear on the main power / energy screen. Make sure to remove the diffuser from the sensor.
6. Press "laser" and select the correct wavelength. Note that only wavelengths compatible with the diffuser setting are visible. (All wavelengths for diffuser "IN" have a D suffix, e.g. 106D = 1.06 μ m).
7. In addition make sure to change the pulse length setting if necessary.

Chapter 7.

BeamTrack Features

Some of our thermopile sensors are equipped with circuitry enables them to measure the laser's position as well as the spot size in addition to standard power and energy measurement.

This chapter describes the Nova II's position and size measurement functionality. For a full description of Thermopile functionality see [Chapter 4 Operation with Thermopile Absorber Sensors](#).

7.1 Track Screen

This screen shows the position of the laser beam as measured by the sensor. If the beam is close enough to the center and the sensor is capable of size measurement, then the laser beam will be displayed as a spot drawn to scale. Otherwise, the location will be displayed as an X.

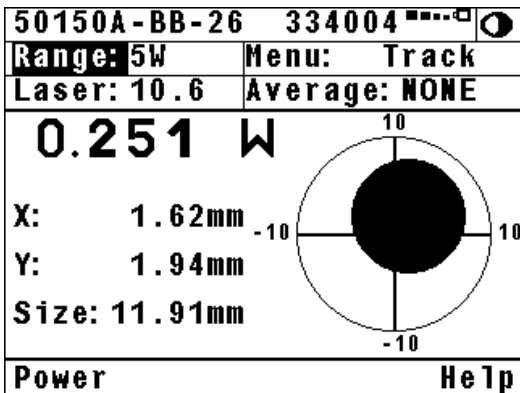

Figure 7.1
Main Track Screen

To get to this screen, press the "Track" softkey in the Energy screen. This screen can also be set up as the default startup mode in the Configuration Screen.

7.2 Menu Screen

To access the various other BeamTrack features, go to the Menu screen from the main Track Screen.

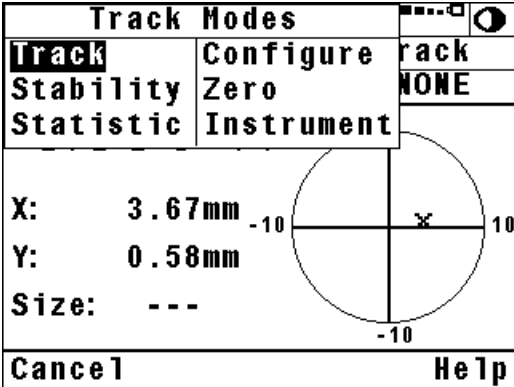

Figure 7.2
BeamTrack Menu Screen

7.3 Stability Screen

This screen tracks the position of the laser beam over time. This is useful for users that want to measure the pointing stability of their laser.

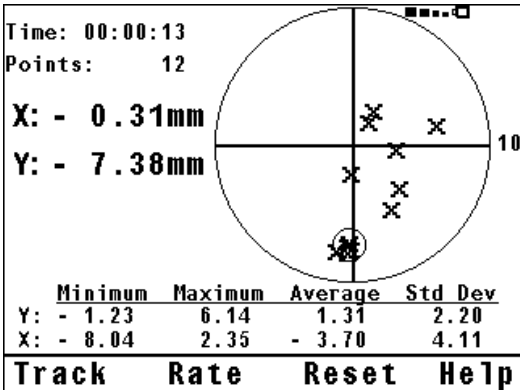

Figure 7.3
Pointing Stability

A circle is drawn around the latest measurement to be recorded.

Press the "Rate" softkey to change the sampling rate.

Press the "Reset" softkey to erase the graph and clear the statistics.

7.4 Statistics Screen

This screen shows statistics for power, position, and size measurement over time.

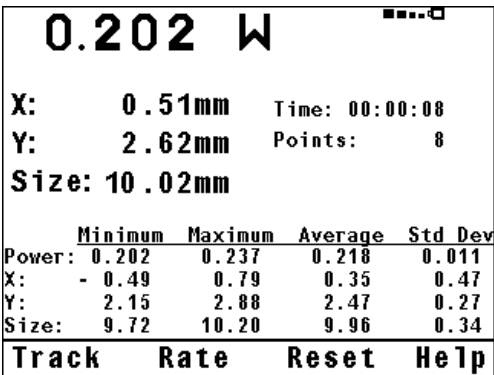

Figure 7.4
Statistics Screen

Press the "Rate" softkey to change the sampling rate.
Press the "Reset" softkey to clear the statistics.

7.5 Optimizing Measurements

7.5.1. Zeroing.

When a BeamTrack sensor is attached, the zeroing function of the Nova II will zero the BeamTrack's measurement circuitry as well.

7.5.2. Line Frequency.

In order to filter out noise that may be introduced to the measurements from the local power supply, in the

Configuration Screen, set Line Frequency to 50Hz or 60Hz, depending on the country you're in.

50150A-BB-26		■■■■□○	
Menu:	Configuration		
Startup Mode:	Track		
Display Mode:	Power/Energy		
Power Range:	5W		
Average:	NONE		
Sample Rate:	1 sec		
Line Freq	60Hz		
Laser:	10.6		
Exit	Info	Save	Help

Figure 7.5
Configuration Screen

Chapter 8. Circuit Description

The NOVA II has two circuit boards: the lower board with analog circuit, digital processor and its support circuit, and power supplies; and the upper board with LCD and its driver.

Analog Circuit:

The signal from the detector sensor enters the analog circuit and passes through EMI protection components to a differential trans-impedance preamplifier. From there it is further amplified by a programmable gain voltage amplifier and passes to an Analog-to-Digital (A/D) converter. All calibration data for the analog circuit is stored in a memory chip on the main board. There are no mechanical adjustable components (trimmers etc.) in the NOVA II.

Fast Analog Input:

In addition to the above basic analog circuit, the Nova II contains a second fast analog input. This supports certain Ophir sensors that read energy pulses at higher rates than can be supported by the basic analog circuit, but provides less overall accuracy than the above circuit. The fast analog input consists of an EMI filtered voltage input that is passed to a first stage of mild voltage attenuation. This is then passed to a fast A/D converter. Calibration data is stored on the same memory chip mentioned above.

Digital Processor:

The digital processor is built around a Motorola MC68332 32-bit micro controller (MCU) with a 16-bit external bus. The digital circuit includes an upgradeable FLASH chip that can be programmed in-situ by NOVA-II support software. In addition there is a static battery-backed RAM chip totaling 512Kbytes of RAM. The large amount of RAM allows storage of large

amounts of logged data permanently, even when the instrument is turned off. (See section 4.4.2.6.1 on data storage). The digital processor receives data from the A/D converter and translates it into a measurement of current in Amps. When used with thermopile sensors, the data is then processed by a sophisticated digital filter that speeds up the effective response time of the sensor and rejects noise. In addition, the MCU converts data from the fast A/D converter and translates it into a measurement that can be processed as necessary. The MCU is also responsible for reading the keypad, driving the LCD display and communicating via USB or RS232.

The MCU obtains calibration and capability data from a memory chip in the plug of the detector sensor and configures itself accordingly. Recalibration data and saved settings are also stored in this memory chip. A single DIN socket is used for communications via USB or RS232. Only one or other of these communication options is available at any one time.

Power Supply:

The power supply provides the internal DC supply voltages for the analog and digital processors, and to the external sensor detector. It also contains the battery charging circuit and the AC supply for the backlight. The power supply circuits consist of high efficiency switch-mode designs.

EMI Protection:

The digital processor circuit and the whole NOVA-II instrument is protected by EMI protection component on all signals that pass in and out of the box. In addition, EMI protection is added internally to prevent disturbances to the normal functioning of the instrument. The instrument meets the requirements of the European Community with respect to electromagnetic compatibility and has the "CE" mark.

Chapter 9.

Calibration, Maintenance and Troubleshooting

9.1 Calibration of Thermopile or RP Sensors

9.1.1. Absorber types and Method of Calibration of Ophir Power Meters

9.1.1.1. Types of Ophir Laser Absorbers

Two types of absorber surface are used in Ophir thermal measuring sensors.

1. Surface Absorbers:

BB (broadband) absorber

On standard, high power density, broadband Ophir power monitor sensors, a special refractory coating is used to provide high absorptivity from the UV through the IR. This coating can withstand very high power densities, up to 28 kW/cm², without changing calibration. The absorption of this coating is above 85% for most of its range, as shown in Graph below.

EX (excimer) absorber

The EX absorber provides high absorption in the UV, and it can withstand both the pulse energies and the average power of excimer lasers. These discs also have excellent absorption for 10.6 μm and other wavelengths. They can therefore be used for other types of lasers as well. The absorption of the various Ophir absorbers as a function of wavelength is shown in Graph below.

LP1 (long pulse) absorber

This absorber has a very high damage threshold for long pulse (ms) or continuous lasers and is therefore offered for use with high power and energy

lasers. It is calibrated for the spectral range 250 – 2200nm with some sensors also being calibrated for 2940nm.

2. Volume absorbers:

P (pulse) type absorber

The models with the P suffix, for use with pulsed lasers, have a special absorbing glass with an absorbance of $95\pm 2\%$ over the operating range. Since the surface is a glass, its reflectivity does not change even if damaged or melted locally.

HE (high energy) absorber

The HE type has a particularly high damage threshold for pulsed and repetitively pulsed lasers of both the short and long pulse variety and is useful where the highest pulse energies and average powers are used.

PF (high energy high average power) absorber

The newest PF type absorber has a high damage threshold for short pulses and can stand relatively high average power density as well. In addition it is able to be deposited on large areas so it is the absorber of choice for many applications.

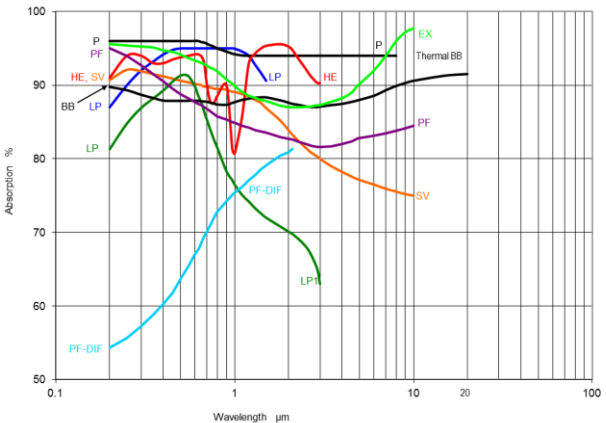

Graph 1.

Absorption vs. Wavelength of Various Thermal Sensor Absorbers

Ophir power/energy meters with the Broadband, P or PF type absorbers are individually calibrated by laser at several wavelengths against a NIST calibrated standard meter. The meter can be switched to give the exact calibration at the various wavelengths (532nm, 1064nm and, where applicable, CO₂). Since the sensitivity changes little with wavelength, the user can use the settings closest to the calibration wavelength with little error.

The EX type detector is calibrated in the UV at 248nm to cover the entire UV range from 193 to 400nm.

9.1.2. Linearity and Accuracy of Ophir Thermal Sensors

9.1.2.1. Linearity

The linearity of most Ophir thermal detectors is specified to be 1% over the specified power range of each particular instrument and is tested by Ophir from time to time. The linearity is generally tested against another sensor that has been NIST tested for linearity. For those models for which the linearity is not tested over their entire range, randomly chosen sample models are tested periodically over their entire range. The test is performed with a high power laser that can cover the entire detector range using a beam splitter and lower power sensor that has previously been tested for linearity for comparison. Thus, in all cases, the linearity of the detectors is traceable to NIST measurements.

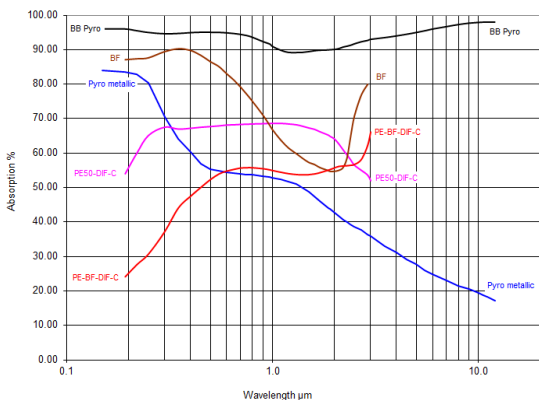

Graph 2.
Absorption vs. Wavelength of Various Pyroelectric
Sensor Absorbers

9.1.2.2. Method of Calibration

The absorption of the various Ophir thermal absorbers can vary from disc to disc. Therefore, all Ophir absorbers are individually calibrated against NIST traceable standards.

9.1.2.3. Total Accuracy of Calibration

A detailed discussion of Ophir calibration accuracy is available on the Ophir website at <http://www.ophiropt.com/laser-measurement-instruments/laser-power-energy-meters/tutorial/calibration-procedure>

9.1.3. Recalibration from a Known Source of Laser Power / Energy

1. From the main measurement screen select "menu" and select "calibrate". Select "calibrate" Enter "Ad:" and select "specific: this laser only".
2. Enter "laser" and select the proper laser wavelength. Enter "average" and enter the desired averaging period.

3. Enter "factor" and apply the known laser power/energy.
4. Enter the "modify " screen and adjust the factor until the power/energy reading on the screen equals the known power/energy. Press "save" and the power/energy calibration factor under "updated" will change accordingly. See Note 1.

Note 1:

For units which have different calibration factors, e.g. CO₂, YAG, or VIS, press "laser" to select correct type of laser before calibration. When recalibrating using "specific: this laser only" function, only the calibration of the chosen laser wavelength will change. If you wish to change the calibration of all wavelengths proportionately, then use the function "overall: all lasers".

Note 2:

When changing power calibration, this will also change energy calibration proportionately. However, changing energy calibration will not change power calibration.

9.2 Calibration of Photodiode type Sensors

Photodiode detectors are inherently very linear but also have a large variation in sensitivity with wavelength. In addition, most sensors from the Ophir PD300 series are equipped with both a built in filter and removable filter to allow measurement of higher powers without detector saturation. These filters also have a transmission that depends on wavelength. Therefore, when the PD300 is being used with the Nova II, the Nova II has a built in calibration adjustment for wavelength which is described in the next paragraph.

9.2.1. Method of Factory Calibration

The sensitivity of various Ophir photodiode sensors can vary from one to another as well as with wavelengths. Therefore, Ophir photodiode detectors are individually calibrated against NIST traceable standards over the entire operating range of wavelengths for both filter out and filter in. The calibration curve is normalized to the correct absolute calibration at 632.8 nm using a HeNe laser against a reference meter traceable to NIST.

The spectral sensitivity curve of the detector as well as the spectral transmission curve of the filters is fed into the sensor EEROM and this information is used to set the gain to the proper value at wavelengths other than the wavelength the instrument was calibrated. When the user selects his wavelength on the Nova II, the correction factor for that wavelength is applied.

9.2.2. Accuracy of Calibration

Since the instruments are calibrated against NIST standards, the accuracy is generally $\pm 2\%$ at the wavelength the calibration has been performed. The maximum error in measurement will be less than the sum of the calibration accuracy, linearity, inaccuracy due to errors in the wavelength curve and variations in gain with temperature. The linearity of the photodiode detector is extremely high and errors due to this factor can be ignored. The maximum error due to the above factors is given in Table below.

Wave Length	Error, Filter Out*						
	PD300	PD300-TP	PD300-3W	PD300-UV	PD300-IR	PD300-IRG	3A-IS
200 - 270nm				$\pm 6\%$			
270 - 360nm	-		-	$\pm 3\%$			-
360 - 400nm	$\pm 10\%$	$\pm 7\%$	$\pm 10\%$	$\pm 3\%$			-
400 - 950nm	$\pm 3\%$	$\pm 3\%$	$\pm 3\%$	$\pm 3\%$			5%
950 - 1100nm	$\pm 5\%$	$\pm 5\%$	$\pm 5\%$	$\pm 5\%$	$\pm 4\%$		10%
1100 - 1650nm	-		-	-	$\pm 4\%$	$\pm 3\%$	
1650 - 1800nm	-		-	-	$\pm 7\%$	$\pm 5\%$	

* Add $\pm 2\%$ to error for filter in ($\pm 4\%$ for PD300-UV from 220 to 400nm).

Table 3.
Maximum Error as a Function of Wavelength and Filter

Note:

More exact specifications will be found in the latest Ophir Laser Measurement Instruments Catalog.

9.2.3. Recalibration at a specific wavelength from a Known Source of Laser Power

1. From the main measurement screen select "menu" and enter. Select "calibrate" and enter.
2. Enter "laser" and select the proper laser wavelength. Enter "average" and enter the desired averaging period.
3. Enter "factor" and apply the known laser power/energy.
4. Enter the "modify" screen and adjust the factor until the power/energy reading on the screen equals the known power/energy. Press "save" and the power/energy calibration factor under "updated" will change accordingly. See Note 1.

Note 1:

The relative readings at different wavelengths are fixed by the wavelength calibration curve stored in the sensor EEROM. When changing the calibration at one wavelength, the calibration at all other wavelengths will change proportionately.

9.3 Calibration of Pyroelectric type Sensors

9.3.1. Two main types of absorber surface are used in Ophir pyroelectric measuring sensors

1. **Metallic type:** The type with no suffix in the name have a partially reflective multilayer metallic coating which absorbs approximately 50% and whose absorption graph is shown in Graph 3 below. The metallic coating permits very high repetition rates, up to 25,000Hz as well as relatively high damage threshold.
2. **BF type:** The type with the BF suffix has a broadband absorbing coating to provide high absorptivity from the UV through the IR. This coating can withstand energy densities, up to 0.8

J/cm² for short pulses and 2J/cm² for long pulses without changing calibration. The absorption of this coating is above 90% for most of its range, as shown in Graph 3 below. This coating is available for the PE50, PE25 and PE10 sensors. For even higher damage thresholds, there are the – DIF diffuser series with a diffuser in front of the absorber.

- PD10 Series:** Unlike the other sensors, the PD10 series sensors have a silicon or germanium photodiode with a neutral density filter mounted permanently in front of it. The filter detector combinations are calibrated over the entire wavelength range similarly to the PD300 power sensors and therefore the sensors have a high accuracy at any wavelength in the range. This is an exclusive feature with Ophir energy sensors.

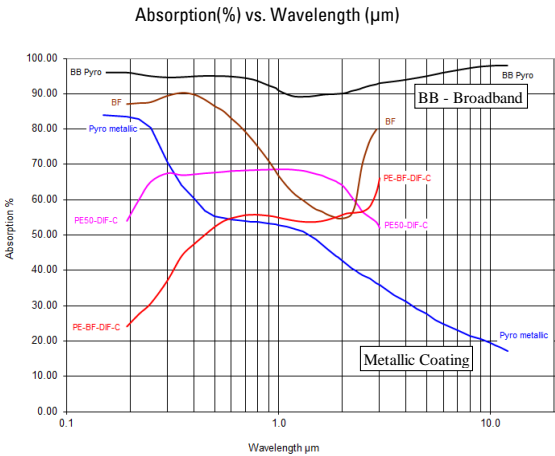

Graph 3.
Absorption of Ophir Pyroelectric Absorbers

9.3.2. Calibration

The sensitivity of the various Ophir pyroelectric sensors can vary from one to another as well as with wavelengths. Therefore, Ophir pyroelectric detectors are individually calibrated against NIST traceable standards. In addition, there is a wavelength sensitivity correction curve in the Meter.

Ophir pyroelectric detectors are calibrated using a 1064nm repetitively pulsed laser referenced to a NIST traceable thermal power meter. The average energy is set to the average power of the standard power meter divided by the laser frequency.

The spectral absorption of the detector coating is measured spectroscopically and the absorption curve is used to correct the calibration for other wavelengths. When the user selects his wavelength on the Meter, the correction factor for that wavelength is applied.

The PD10 & PD10-PJ sensors are calibrated in a two step fashion. First the photodiode detector - filter combination is calibrated against a NIST traceable master over the wavelength range of the sensor in a similar fashion to the PD300 sensors. Then the sensor is calibrated at one wavelength using a 905nm repetitively pulsed laser referenced to a NIST traceable photodiode meter. The average energy is set to the average power of the standard power meter divided by the laser frequency.

9.3.3. Accuracy of Calibration

Since the instruments are calibrated against NIST standards, the accuracy is generally 3% at the energy level and wavelength at which the calibration has been performed. This accuracy has been verified by checking the scatter of the results when several instruments are calibrated against the same standard. The maximum error in measurement will be less than the sum of the specified accuracy, linearity and inaccuracy due to errors in the wavelength curve.

The non-linearity is approximately 2%, and the error due to wavelength is given in table 3 above.

In addition to the above errors, the reading of pyroelectric sensors changes with frequency. The sensor has a built in correction for this error. For frequencies above 50% of maximum frequency, inaccuracies in this correction can increase the total error by up to about 3%.

The maximum error in measurement will be less than the sum of the above errors and in general will be considerably less. The exact accuracy of each type of sensor is specified in the latest edition of the Ophir catalog. For more details on calibration accuracy, see the Ophir website at <http://www.ophiropt.com/laser-measurement-instruments/laser-power-energy-meters/tutorial/calibration-procedure> and see the specification sheet for the specific sensor you are using.

9.3.4. Recalibration from a Known Source of Laser Energy

1. Set the instrument to "energy".
2. Set to the proper energy range.
3. (For broadband type sensors only. See note 1). From the main screen enter "menu" and select "calibrate". Enter and select "Adj:". Select "specific: this laser only" if you only want to change the calibration of this wavelength or "overall: all lasers" if you want to change all wavelengths together proportionately.
4. Enter "factor" and apply the known laser power/energy.
5. Enter the "modify " screen and adjust the factor until the energy reading on the screen equals the known energy. Press "save" and the energy calibration factor under "updated" will change accordingly. See Note 1.

Note 1:

For metallic and PD10 & PD10-PJ type sensors, when the calibration is changed at one laser wavelength, the overall calibration of all other wavelengths changes proportionately.

9.4 Error Messages

The Nova II displays various error messages when operated outside its normal range:

Over range: When the power or energy being measured exceeds the range of the measurement scale being used, the "over" message is displayed, but the reading still appears on the display. If the power or energy exceeds the maximum by more than 10%, the reading on the display is blanked.

Low Battery: When the battery is almost discharged, the Battery icon will have only 1 segment left. This means the battery is $\frac{3}{4}$ empty. At this stage, the Nova II should be connected to the charger. It will operate normally and charge slowly while connected to the charger. Also, the Backlight will turn off when the battery is low.

Sat: When the photodiode current exceeds 1mA, and the detector starts to saturate, or the pyroelectric voltage exceeds the maximum, the message "sat " (=saturated) is displayed.

9.5 Troubleshooting

9.5.1. Nova II Meter

Problem	Cause/Remedy
Instrument will not operate after being completely discharged and connected to charger.	Check that charger provides 200mA.
Instrument operates with charger but not with battery alone.	Battery is low. Recharge overnight with the Nova II turned off for 18-21 hours. If the Nova II still doesn't work with battery, then the NiMH battery is probably dead. Replace battery (see section 9.6.1.4).

9.5.2. Thermal Sensors, Energy Measurements

Problem	Cause/Remedy
Instrument triggers on background noise or sometimes fails to catch large pulse.	Increase threshold level; See Section 4.5.3
Instrument does not show ready for a long while after a reading is made.	Increase threshold level; See Section 4.5.3
Non-reproducible results when measuring very small energy pulses; or no response to pulses at low energy.	Decrease threshold level: See Section 4.5.3

9.5.3. Thermal Sensors, Power

Problem	Cause/Remedy
Instrument shows zero reading in both power and energy modes.	Check connections between the sensor and the instrument. (see section 9.6.1.1). Check that the sensor disc is operative. Resistance between the pins 1 and 9 of the sensor connector should be about 11k. If the sensor is defective, there will be an open or short circuit.
Instrument responds while sensor is cold, but suddenly fails as it heats up.	Replace sensor disc. See Section-9.6.1.2
Instrument does not return completely to zero on power measurement.	If sensor is very hot, allow it to cool. Disconnect the sensor from the instrument. If readout unit does not zero, follow instructions in section 3.5.5. If the offset persists, try zeroing with the sensor connected as well, as described in the same section.

9.5.4. Pyroelectric Sensors

Problem	Cause/Remedy
Instrument reads incorrectly or erratically, especially on sensitive scale.	Possible electromagnetic interference from pulsing laser is causing misreading and/or false triggering
Instrument triggers even without being exposed to laser pulses.	Check the following: Sensor is mounted to stand using insulated plastic rod provided with instrument, and not metal rod.
Instrument shows frequency which is too high	1. Try keeping cable away from bench. 2. Move sensor/display further away from EMI.

9.6 Maintenance

9.6.1. Battery Replacement

If the Nova II battery is defective and does not hold a charge, a replacement can be ordered from your agent (Ophir part number 7E14007). The new battery is installed as follows:

1. Ensure the NOVA-II is switched OFF. Turn the Nova II meter upside down and unscrew the 4 Phillips screws on the bottom panel of the NOVA-II.
2. Remove the bottom panel and disconnect the battery connector (red and black leads) from the circuit, by holding the two wires firmly and tugging them firmly in a direction away from the circuit board.
3. Insert the new battery into the same location in place of the old battery. Reconnect the battery connector into its terminal on the circuit board. The RED and BLK (black) symbols on the circuit board indicate the correct direction to insert the connector into its terminal. It can only be inserted in one direction.
4. Replace the bottom panel of the NOVA-II and close the 4 screws.
5. Switch on the NOVA-II with NO SENSOR DETECTOR attached and set the date and time of the instrument correctly. (see section 3.5.4)

Chapter 10. Nova II Specifications

10.1 System/Meter Specifications

Input Specifications Thermal, Photodiode		
Input Ranges	15nA - 1.5mA full scale in 16 ranges	
A to D Sampling rate	15Hz	
A to D resolution and linearity	Resolution: 23 bits plus sign. (0.00001%); Linearity: better than 17 bits (0.0009%)	
Electrical accuracy	±0.25% ± 20pA new; ±0.5% ±50pA after 1 year	
Electrical input noise level	500nV or 1.5pA + 0.0015% of input range @3Hz.	
Dynamic range	9 decades (1:10 ⁹)	
Input Specifications Pyroelectric Sensors		
Input Range	0 - 6V full scale	
A to D Sampling rate	4KHz	
A to D resolution	12 bits no sign (0.025% resolution)	
Electrical accuracy	±0.25% new; ±0.5% after 1 year	
Electrical input noise	2mV	
General Specifications		
Detector Compatibility	Thermopile, photodiode and pyroelectric	
Analog output	4 scales, user-configurable: 1v,2v,5v,10v full-scale; 0.03% resolution. 100 ohms impedance	
Analog output accuracy	±0.2% (of reading) ±0.3% of full scale volts	
Dimensions	110W x 40D x 210H	
Mass	550g	
Display	320x240 pixel super twist LCD; Active area 77x57mm approx	
Display digit height	18.5mm	
Backlight	EL: Operates from charger or battery	
Bargraph segments	320	
Battery	3 x AA size. 2.4Ah NiMH battery built in.	
Charger input	DC: 12 -25V, 5W; AC: 9 - 18V RMS, 5W. Charge time 7-8 hours; automatically switches to trickle charge when battery is full	
Operation between charges	18 Hrs, thermal and photodiode, 13 Hrs, pyroelectric sensors; With Backlight: 9/8 hours respectively	
Data Logging and Com.		
Power Measurement		
	RS232	USB
Power log period	20sec to 600 hours for both	
Max points stored onboard per file	5,400	5,400
Max points direct to PC file in real time	unlimited	unlimited
Energy measurement		
	RS232	USB
Max real time data logging rate	>30Hz	>2000Hz
Max onboard data logging rate	4000Hz	4000Hz
Data transfer of log file from instrument to PC	~500 points/s	>1000 points/s
Max points stored onboard	59,400	59,400
General	Maximum communication rate 38400 baud (RS232)	
Memory data storage	10 data files of 5400 points each. Data is not lost when instrument is turned off.	

Table 4.
Specifications of System/Meter

- (1): Can store up to 10 files for a total of 54,000 points.
 (2): The above refers to the rate for logging every single point in turbo mode. Above that rate the instrument will sample points but not log every single point.

10.2 Sensor Specifications

Sensor	Max Power (WATTS)	Max Avg. Power Density at Max Power	Absorber Type
PD300/UV/IR	300mW	50W/cm ²	PD
PD300-3W	3W	100W/cm ²	PD
3A-IS	3W	200W/cm ²	Int Sph PD
3A	3W	1000W/cm ²	BB
3A-P	3W	50W/cm ²	P
3A-FS	3W	200W/cm ²	FS
10A	10W	28KW/cm ²	BB
12A	12W	25KW/cm ²	BB
12A-P	12W	50W/cm ²	P
20C-SH	4(20)W	23KW/cm ²	BB
30A-BB-18	30W	20KW/cm ²	BB
30A-P-17	30W	50W/cm ²	P
L30A-10MM	30W	20KW/cm ²	BB
50A-PF-DIF-18	50W	0.5KW/cm ²	PF-DIF
30(150)A-BB-18	30(150)W	12KW/cm ²	BB
30(150)A-HE-17	30(150)W	500W/cm ²	HE
50(150)A-BB-26	50(150)W	12KW/cm ²	BB
L50(150)A-BB-35	50(150)W	12KW/cm ²	BB
L50(150)A-LP1-35	50(150)W	38KW/cm ²	LP1
L50(150)A-EX-35	50(150)W	2KW/cm ²	EX
L40(150)A	35(150)W	12KW/cm ²	BB
L40(150)A-LP1	35(150)W	38KW/cm ²	LP1
F150A-BB-26	150W	12KW/cm ²	BB
FL250A-BB-35	250W	10KW/cm ²	BB
L250W	250W	10KW/cm ²	BB
FL400A-BB-50	400W	8KW/cm ²	BB
FL500A	500W	7KW/cm ²	BB
1000W/1000W-LP	1000W	6/7KW/cm ²	BB/LP
L1500W/L1500W-LP	1500W	5/6KW/cm ²	BB/LP
5000W/5000W-LP	5000W	3/4KW/cm ²	BB/LP
10K-W	10000W	10KW/cm ²	BB
PD10	50mW	50W/cm ²	PD
PE9	2W	30W/cm ²	PE
PE10-BF-C	3W	50W/cm ²	PE-BF
PE25-C	25W	20W/cm ²	PE
PE25BF-C	25W	20W/cm ²	PE-BF
PE25BF-DIF-C	30W	120W/cm ²	PE-BF-DIF
PE50-C	25W	20W/cm ²	PE
PE50-DIF-C	30W	100W/cm ²	PE-DIF
PE50BF-C	25W	20W/cm ²	PE-BF
PE50BF-DIF-C	30W	200W/cm ²	PE-BF-DIF
PE100BF-DIF	40W	500W/cm ²	PE-BF-DIF

Table 5.

Max Power Specifications of Sensors

PD - Photodiode

P - P type volume absorber for short pulse lasers

PF - volume absorber for short pulses and high average powers

HE/HE1 - volume absorber for high energy pulses

EX - Excimer type, volume absorber

PE - pyroelectric metallic or black absorber

- BB - broadband surface absorber, high power density
- LP1 - broadband surface absorber for highest power density
- BF - very high damage threshold, long pulses
- FS - Fused silica window close to detector for divergent beams

Note:

For more detailed and exact specifications, see the latest Ophir Laser Measurement Instruments Catalog.

Absorber Type	Max Energy Density J/cm ² Pulse Length		
	10ns	1μs	300μs
P	10	10	10
HE/HE1	3	5	15
BB	0.3	0.5	3
LP1	0.09	0.5	10
EX	0.8	0.9	7
PE, Metallic	0.2	0.5	4
PE, BB	0.5	0.5	1
PE-DIF	1	2	20
PE BB-DIF	3	3	10

Table 6.
Maximum Energy Densities for Various Absorbers (Single pulse)

Note: The CW power damage threshold in W/cm² is found on the right hand side of the table at the 1s pulse width value.

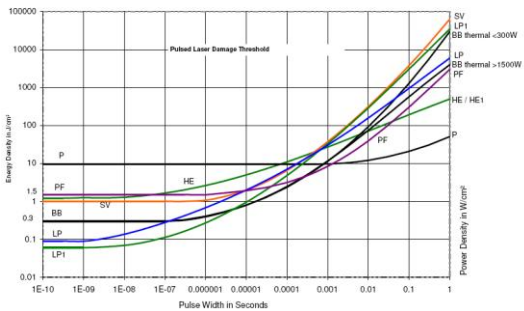

Graph 4.
Pulsed Laser Damage Threshold for Thermal Sensors

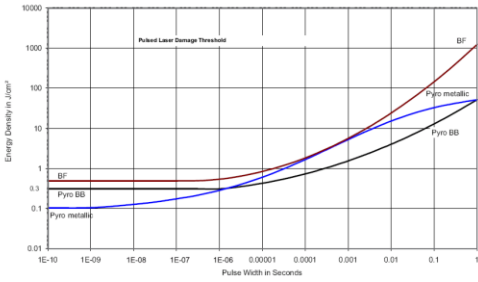

Graph 5.

Pulsed Laser Damage Threshold for Pyroelectric Sensors

Nova II User Manual
 03 February 2019
 Rev 2.37-2

For latest version, please visit our website: www.ophiropt.com/photronics